

RIMMER BROS



**AUTHORISED
MG ROVER PARTS
DISTRIBUTOR**

Quickfinder PARTS & ACCESSORIES Catalogue & Price Guide

*Original MG Rover Parts
& Aftermarket Parts*

2010

Even More
**CLEARANCE
BARGAINS**

- WORLDWIDE MAIL ORDER SERVICE
- COUNTER SERVICE
- LOCAL TRADE DELIVERY SERVICE



Also available:

TRIUMPH PRICE GUIDE
COVERING ALL TRIUMPH & ROVER SD1 MODELS

LAND ROVER PRICE GUIDE
COVERING RANGE ROVER, DISCOVERY, DEFENDER & FREELANDER

Tel: 01522 568000

E-mail: mgrover@rimmerbros.co.uk

Rimmer Bros.
Triumph House, Sleaford Rd,
Bracebridge Heath,
Lincoln, LN4 2NA England.
Fax: 01522 567600.



**View our On-line
Electronic
Parts Catalogue!**

www.rimmerbros.co.uk

SOURCE CODE: MGRP610

HOW TO ORDER

COLLECTING IN PERSON

If you wish to 'call and collect', you will always be made welcome at our shop and sales counter during business hours. Our Visitor Information Centre has lots of interesting details of each production model and the factories where they were produced.

Customers drive here regularly from all over Europe. Lincoln is a historic Cathedral city and is an excellent place to visit. We're about 2 miles south of Lincoln on the A15 Lincoln to Sleaford road (see map on back cover). We advise you to pre-check by phone that we have the part/s you want in stock.

We accept payment by credit, debit or charge card, cash, bank draft, travellers cheque, building society cheque, and personal cheque (when presented with a cheque card) even if the cheque card limit is exceeded, and by business cheque with accompanying letterhead.

ORDERING BY PHONE



Please quote your home postcode and part numbers where possible. This gives instant access to our computerised records and stock control system. If you have any difficulty in selecting the parts you need, our expert staff can help.

UK Payment for Phone Orders (See also "Overseas Orders & Payment.")

When you have checked on price, availability and delivery costs you can place your order by phone using Visa, MasterCard, Delta/Connect, Maestro, Solo, JCB, Diners Club, or American Express. You will merely need to tell us the card number, expiry date (or issue number), CVC security number, cardholder's full name and registered card address.

After Hours Ordering Service

We operate a 24-hour answering/ordering service which is available to card holders out of normal hours for both UK and Overseas customers. Just leave all necessary details on our telephone voice mails, ie your vehicle type, year, model, the parts and/or the part numbers you require, plus your name, address (inc. postcode), credit card details and delivery address (if different).

Writing out these details before phoning usually helps a caller to give us clear instructions. If at all possible, please also leave a daytime telephone number.

ORDERING BY POST

Triumph House, Sleaford Road, Bracebridge Heath, Lincoln, LN4 2NA, England.

We ask you to phone first if at all possible - to check your parts selection, and to advise of delivery charges. Because prices and availability sometimes change, we can also confirm the exact remittance needed avoiding unnecessary delays. If you have not been able to telephone, please give us all possible information - car type/year, RH or LH, front/rear etc - so we can check your selection (including your name, address and postcode) in all correspondence.

Use our Order Form if you can (see rear of Price Guide). It asks specifically for all the details we might need. Please photostat or request additional copies of the order form if required.

UK Payment for Post Orders (See also "Overseas Orders & Payment.")

Send your remittance with the order. The 'Pricing' section in the Price Guide tells you how to calculate the amount.

We accept payment by personal cheque even if the cheque guarantee card limit is exceeded. All we require is your full name and address on the back of the cheque along with your cheque card number and for business cheques, a relevant letterhead. Cheques or P.O.s made out "Rimmer Bros Ltd" please.

Note, if you are unsure as to the exact amount to send, you can write across the top of your cheque, "Cheque Value Not To Exceed £...". You can post us your credit card details if you prefer. If you send cash, note that we cannot accept responsibility for any loss, so registered mail is essential. Bank drafts and Building Society cheques are also accepted.

Trade & Wholesale enquiries welcome
Ask for a copy of our Trade Programme document and credit application form.

Errors & Omissions Excepted. All parts offered subject to availability. Correct at August 2010.
We reserve the right to alter prices without notice.



ORDERING BY FAX

01522 567600

Another facility for customers who wish to make enquiries, or order by credit, debit or charge card. Again, we will need your name, address (inc. postcode), credit card details including CVC security number and delivery address (if different). Plus fullest possible car/parts details - as for orders by post.

ORDERING ONLINE 24/7 & BY E-MAIL

www.rimmerbros.co.uk

E-Mail: mgrover@rimmerbros.co.uk

Use our E-Mail address for sending your order or parts enquiry. State if you require us to confirm prices, as they can sometimes alter at short notice.

MINIMUM ORDER VALUE

We respectfully request a minimum £5 order value. It is uneconomical for us to process an order for less than this amount. In addition, we have a minimum postage charge which inevitably pushes up the cost of small, low value parts. It is therefore better for you (and for us) if your order can be a minimum of £5 which results in far better value for money.

P.S. Why not add an oil filter to your order!

FRAUD PREVENTION

We wish to confirm to our customers that we do not show your credit card details on any paperwork nor do we pass on any details held on our database to any 3rd parties. We also now insist that your first order must be delivered to the card holders registered address. We will also ask for the 3 digit security number found on the signature strip. These measures for first-time users will help prevent unauthorised use of a credit/debit card. Additionally we randomly select orders for authorisation checks.

WARRANTY

PARTS WARRANTY All new and reconditioned parts are covered by a 12 month manufacturer's warranty unless specifically stated. You should notify us immediately if a potential warranty situation arises. The warranty period commences from our invoice date not from the date of installation or first use. This warranty covers defects to the part when fitted and used correctly for normal, everyday vehicle use but does not apply to parts used for any extraordinary or unusual uses such as competition, racing, rallying or parts subsequently stripped down, altered, modified or adapted etc. in any way from their original design or intended use. Although we are, by law, liable for death or personal injury caused by our proven negligence and by The Sale of Goods Act 1979, our warranty only covers the parts in question and not to any consequential loss or cost, e.g. garage labour, recovery, car hire, re-delivery, parking fines, etc. No claim will be validated if the failure is caused by mis-use, neglect, overheating, incorrect installation or failure of a related component. Any part replaced or repaired under warranty, will only benefit from the balance of the cover remaining from the original purchase date. Warranties are not transferable. Acceptance of goods is deemed as acceptance of these terms. The warranties are in addition to, and do not affect your statutory consumer rights.

How to Claim In the rare event of a new or reconditioned part becoming faulty, please notify us immediately. It must be returned to us together with the original invoice or proof of purchase with as much information relating to the fault as possible.

Please note that the defective part must be returned and received before it can be exchanged.

CHECK OUR WEBSITE FOR UP TO DATE PRICES





GENERAL INFORMATION

PRICING

Prices We show two columns of prices, one excluding VAT (for worldwide, outside EC countries) and one including VAT (currently 17.5% for UK and EC countries). The cost of delivery should be added to the cost of the part(s). See 'Delivery Methods'.

Prices in this **Price Guide** were correct at the time of going to press but are subject to change without prior notice. **Please confirm all prices when ordering.**

All goods are sold subject to the price ruling at the time of invoicing.

Note:- up to date prices are available on our website.

VAT Residents of UK and EC countries pay VAT (currently 17.5%) on parts and delivery. For EC businesses who are VAT registered, we require your VAT number and official order to export at VAT exempt prices.

For worldwide (outside the EC) orders sent direct from our premises, VAT is not applicable.

N.B. Books and manuals are currently zero rated for VAT purposes.

Written Quotation

If you require a written quotation for the part(s) and/or delivery charge(s) before ordering, please ask.

DELIVERY METHODS

UNITED KINGDOM

Delivery charges (including packaging & handling) are calculated on the weight of the consignment (and volume if large/bulky item) and the desired delivery method (Royal Mail, UPS, etc.) If you are posting your order to us then please request an exact remittance. All prices subject to change.

Post from £2.75 (+ vat)

Carrier from £9.95 (+ vat)

Supplements are applied to Next Day, Saturday, Royal Mail Special Delivery and out of area rural destinations including Highlands, Scottish Islands, Northern Ireland, Isle of Man, Isle of Wight and Channel Islands.

Any quoted delivery times are for 'Working Days' from despatch and exclude weekends and bank holidays. All delivery times are guides, no guarantees can be given. Certain large or bulky items may incur additional packing charges. Please note that the delivery driver may need assistance to unload large/ heavy items - Please advise if special delivery arrangements are required.

OVERSEAS

Worldwide (Non EU Countries)

We started exporting parts worldwide in 1982 and since then we have gained an excellent reputation for our speed and efficiency of service. Delivery costs are based on size, weight and method of delivery. We have discounted rates with well known carriers, so costs are kept to a minimum. Please note that costs are calculated by carriers on both actual and dimensional weights and the higher is charged. Send us a list of the parts you need (using post, phone, fax, our website or e-mail), tell us quantities and urgency, and we will work out the best delivery method and quickly advise you of the cost. Written quotations are available on request. Please note that any local import duty, taxes or customs clearance are not included in our prices and must be paid by you.

EU Countries

The European Union Single Market permits the free movement of goods between all EU countries. This allows us to provide a superb service to all our customers within the EU, with the benefits of improved delivery - via lower charges and easier documentation. Deliveries can be easily arranged using air or surface transport. Please request a competitive quotation for the cost of shipping. Deliveries can take 3-7 working days from despatch. If you are posting your order to us, please request an exact remittance.

Overseas Shipping - Guide Prices

The table below indicates the shipping cost of a single (non oversized) parcel to certain destinations and exclude vat (where applicable). The prices are subject to any increased costs imposed by the carrier, such as increased fuel surcharge etc. We quote separately for oversized/heavy consignments and any packaging charges. As noted above, exact costs will only be known once the order has been packed, weighed and sized.

DESTINATION	5kg	10kg	15kg	30kg
France/Germany*	£14.50	£14.50	£14.50	£14.50
Italy/Spain*	£19.50	£19.50	£19.50	£19.90
Switzerland/ Norway	£24.50	£30.95	£37.75	£37.95
USA	£37.50	£49.95	£60.50	£91.50

*Note: excludes VAT (currently 17.5%)

OVERSEAS ORDERS & PAYMENTS

We supply parts to Car owners worldwide. Delivery costs vary greatly (depending on size/weight/urgency). We can quote accurately for the cost of parts and delivery once your requirements are known.

Payment by Export Customers

Choice of payment methods for customers overseas:

- Credit card, debit card or charge card.
- Bank cheque - in ££s sterling drawn on a London Bank.
- Travellers Cheques (signed) - in ££s sterling or euros (see note below).
- Bank transfer in ££ sterling or euros (see note below) - add £7.00 to cover bank charges.
NAT WEST Bank, Account No. 05839874.
Sort Code 54-10-23.
££ sterling IBAN No GB74NWBK54102305839874
Euro IBAN No GB25NWBK60720906848516
IBAN BIC CODE NWBKGB2L

PLEASE NOTE THAT ALL TRANSACTIONS WILL BE CARRIED OUT IN £ STERLING UNLESS PREVIOUSLY AGREED IN EUROS. PLEASE QUOTE YOUR RIMMER BROS CUSTOMER NUMBER IN ALL CORRESPONDENCE WHERE POSSIBLE.

BACK-ORDERS

Back-ordered items are not charged for until despatch. Upon despatch we will charge the price quoted at the time of ordering. Prices will be unaffected by any subsequent price alterations unless advised in writing to you. Please notify us in writing (letter, fax or e-mail) if you wish to cancel any back ordered items. Back orders will be automatically cancelled after 6 months.

SPECIAL ORDERS

Certain items (coloured trim, carpets, hoods etc) are sometimes only available by special order. This means we have to order them for you specially from the manufacturer. For this reason, we require a 20% non-refundable deposit upon taking your order. The balance is payable when the goods are despatched. Please note that special order items can take several weeks to be supplied.

TROUBLESHOOTER GUIDE

PLEASE CHECK YOUR PARCELS

When you sign for a parcel please inspect it carefully. If it has suffered in transit you can mark the delivery note "Parcel Damaged" before signing or even refuse delivery in serious cases. We do, of course, pack carefully and strongly to help avoid these problems!

Some deliveries involve more than one parcel - please check that ALL have been received.

We must be advised within 48 hours of delivery of any shortages or damaged goods.

LOSS IN TRANSIT

If your parcel does not arrive, we have to establish our claim with the carriers concerned before we can send a replacement consignment. This can sometimes be a lengthy process and if your part is needed urgently a second order can be paid for to save time. We refund one of your orders as soon as the carriers clear our claim.

For items lost by post, 15 working days must elapse (from delivery due date) before a claim can be made, as the Royal Mail will not consider an item as lost until after this period.

RETURNS

All returns MUST be pre-authorized with a returns authorisation (RA) number. Returned products without an RA number will be subject to delay and possible return to sender.

RETURNS OF EXCHANGE 'OLD' UNITS.

There is no specific time limit for the return of exchange old units, except for genuine MGR parts, where old core must be returned within 80 days. Please contact us prior to returning the old unit for a 'Return Authorisation Number'. This speeds up the process of returning the surcharge refund. See reverse of invoice for full details of return procedure.

Please note that old core must be complete, serviceable and drained of fluids where applicable. We reserve the right to retain all or part of the surcharge if the unit is irreparable, damaged or not identical to the type supplied.

RETURNS OF PARTS NOT REQUIRED - WITHIN 7 DAYS

All goods sold by mail order are covered by the Consumer Protection (Distance Selling) Regulations, which allow for a seven day 'cooling off' period during which you may cancel your order (in writing) by sending us a letter, fax or e-mail at any time up to and including the seventh working day after the day on which you received your purchase. If you exercise your statutory right to cancel you must immediately return to us (at your own cost), the item(s) that you do not wish to keep. Carriage charges are non-refundable. We will acknowledge receipt of your written cancellation by issuing a 'Returns Authorisation Number' which should be quoted and accompanied by a proof of purchase or

CONTENTS

HOW TO ORDER	PAGE 1
CLEARANCE BARGAINS	13
NEW PRODUCTS	45
GENERAL ACCESSORIES	61
QUICKFINDER PARTS LISTINGS	
MGF & MG TF	67
MG ZR / ROVER 25 / STREETWISE	79
MG ZS / ROVER 45	82
MGB	85
MG MIDGET & AUSTIN HEALEY SPRITE	88
ROVER 75 V8 / ZT260	90
ROVER 75 / ZT / ZT-T	91
CITY ROVER	94
ROVER MINI	95
NEW MINI	98
MG METRO	100
ROVER 100 / METRO	101
ROVER 200	103
ROVER 200 400	105
ROVER 200 COUPE / CABRIOLET, 400 TOURER	108
ROVER 400	110
ROVER 600	112
ROVER 800 (91-96)	114
ROVER 800 (96 ON)	115
ROVER P5 & P6	117
MONTEGO	118
MAESTRO	120
LUBRICANTS & FLUIDS	122
GENERAL ACCESSORIES	123
PRICES	124

PART NUMBERS

In general, we use MG Rover part numbers to identify original equipment (OE) MG Rover Parts. When an alternative to the OE part is offered (aftermarket) then the part number is identified with a 'P' suffix. Similarly, other variants of the part may be available, such as uprated (UR) or stainless steel (SS) etc.

invoice when returning the goods. Please ensure all goods are adequately packed to avoid damage, that you insure them accordingly with the carrier used and obtain a proof of shipment. Please note that all goods must be in the condition supplied at the point of sale and with their original, undamaged packaging. Returns are not permitted on parts specially ordered by Rimmer Bros on customer's behalf.

RETURNS OF PARTS NOT REQUIRED - WITHIN 7-28 DAYS

As an added benefit to Rimmer Bros customers and in addition to your statutory cancellation right (as detailed above), returns may be considered outside the 7 day cooling off period up to and including 28 days after you receive your purchase, subject to the following criteria.

Please note that any offset, credit or refund will be at the sole discretion of Rimmer Bros' Ltd. A 'Returns Authorisation Number' must be applied for within the 7 to 28 day period. Where goods have been correctly supplied, it may be possible to offset the full value of the return against another order of the same or higher value. Alternatively, a credit note (for the full value) could be offered. Please note that any cash refund will be subject to a handling charge (typically 15% min £5) to cover administration and re-stocking costs. Carriage charges are non-refundable.

All goods returned for a credit or exchange must be accompanied by our invoice quoting the 'Return Authorisation Number'. Please complete the form on the reverse side of the invoice.

Goods must be adequately packed to avoid damage. You should insure them accordingly with the carrier and obtain a proof of shipment. No responsibility can be accepted for goods received by us damaged. Goods must be in the condition supplied at the point of sale and with their original, undamaged packaging. Returns are not permitted on parts specially ordered by Rimmer Bros on customer's behalf.

RETURNS OF PARTS NOT REQUIRED - OUTSIDE 28 DAYS

No returns will be considered after 28 days unless covered by the terms and conditions of our warranty.

OTHER RETURNS

Other returns will be dealt with in accordance with your statutory rights, if applicable, or our warranty.

RETURNS PROCESSING

Please note that returns are processed as quickly as possible. During busy periods, especially in the Spring & Summer, returns may take up to 14 days to process.

Your statutory rights remain unaffected.



GENERAL INFORMATION

AFTERMARKET PARTS & ACCESSORIES

An alternative to genuine MG Rover Parts & Accessories....

Did you know that Rimmer Bros are developing a range of affordable, fast - moving Aftermarket Parts & Accessories for MG Rover Models?

OE (Original Equipment) parts are generally accepted to be of the highest quality. Being made to original specification, they offer perfect fit and a long service life. Most parts are only available as OE, but high demand parts such as Service Items, Brakes, Exhausts, Clutches, Suspension and Shock Absorbers are often manufactured by non OE suppliers and are usually available with a significant cost saving.

Sometimes, certain parts are sold as Aftermarket but are in fact OE, but without the MG Rover branding and packaging. Quite often, Aftermarket parts are a well known brand such as QH, Lucas, TRW, AP Driveline, Unipart etc to name a few - so you are assured that the parts are of suitable quality.

All Aftermarket parts are sold with the same 12 months warranty.

To help identify these parts (in the pricing section at the rear of this catalogue pages 124-151 or on our web site), we suffix the end of the MG Rover part number with a 'P' (for Pattern). For example, MG ZT Front Brake Pads are sold under SFP000040 as OE MG Rover and SFP000040P as Aftermarket. It is therefore easy to compare prices and see the alternatives that are available. We also use this part numbering system to show other variants of the same part. For example, an Uprated Brake Disc would have a 'UR' suffix and a Polyurethane variant of a Standard Bush a "POLY" suffix. The part description will also help confirm the alternative(s).



GENUINE MG ROVER PART
XBC104390
£156.16

AFTERMARKET LUCAS PART
XBC104390P
£126.99

Don't forget to ask if we offer more than one variation of the same part!

EXAMPLE FROM PRICE LISTINGS

Genuine MG Rover Part			
RBX10025	BUSH-FRONT ARM LOWER SUPPORT	11.80	13.87
Aftermarket Part			
RBX10025P	BUSH-FRONT ARM LOWER SUPPORT	5.32	6.25
Variant Part			
RBX10025POLY	BUSH-FRONT ARM LOWER SUPPORT POLY	15.53	18.25

AFTERMARKET AP DRIVELINE PART
URF000170P
£76.00

GENUINE MG ROVER PART
URF000170
£177.68

GENUINE MG ROVER PART
SFP000040
£83.21

AFTERMARKET TRW PART
SFP000040P
£69.71

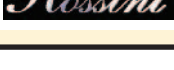



NEWS

Use our website to place your order using our Electronic Parts Catalogue



On-line Price & Availability

Parts Diagrams & Photographs

Easy, Secure Ordering

This Quick Finder Catalogue is intended as a summary listing only for the most popular parts for each model. The full range of products we offer, some 600,000 individual part numbers, can only be found on-line in our Electronic Parts Catalogue where we have line drawn parts diagrams, model range information, photographs, fitting instructions and live stock availability.

Our website also features news, new products, shopping by brand and clearance lines at bargain prices.

Simply navigate in your web browser to www.rimmerbros.co.uk and follow these straightforward instructions:-

- 1) Have to hand any relevant information, such as make, model, vin number, engine number, colour code and also your credit or debit card.
- 2) Click on your vehicle model in the list near the top of the page.
- 3) Click on the section heading that matches the part(s) you require.
- 4) Click on the listing that includes the part(s) you require.
- 5) The item number in the illustration will guide you to the listing in the table below, any additional information such as vin number change point, model application, colour options, quantity required per vehicle will also be shown here. Any alternative versions will be shown such as aftermarket or uprated products. Price and availability are shown to the RH side of the screen.
- 6) Having made your selection, enter the quantity you wish to order in the relevant box on the screen and click the "Add To Cart" button.
- 7) You will be taken to the shopping cart page where you will be shown options to proceed to the checkout, continue shopping, amend your order etc. There is an option to view an example price in 5 different currencies (please note: all orders will be processed in £ Sterling) and the available shipping options will be shown including a guide price if known.
- 8) Once you have completed your order click the "Proceed To Checkout" button where you will have 3 options, for our new customers the middle option allows you to create an account with a password of your choice which has many benefits including email order confirmations, email shipping confirmations, access to your "Wish List", on-line order status, email notifications of sales offers etc. Alternatively the guest checkout option allows checking out without registering.
- 9) Once you have entered your address, contact details and payment method click on the "Continue" button and you will be taken to the order summary page where a recap of your order will be shown and you will have another opportunity to make any last minute adjustments, enter order comments and adjust shipping options. When you are happy to proceed simply select the vehicle that you are ordering for from the list at the bottom of the screen and click on "Submit Order".

www.rimmerbros.co.uk



NEWS

RIMMER BROS

TRADE & WHOLESALE PROGRAM

We have a growing number of established, loyal trade customers who are already benefiting from special net prices on their orders.

If you are a registered trader in the UK or overseas, of any size, you may qualify for a trade account with us... and save money!

So why not contact us (see below) and discuss your requirements or receive a copy of our Wholesale /Trade Program. This program applies to Triumph, Land Rover & MG Rover parts.

Tel: **01522 567111**
(direct line to our wholesale section)

Fax: **01522 567600**

E-mail: trade@rimmerbros.co.uk

Website: www.rimmerbros.co.uk

Key cutting & Remote Fob Programming Service

We can supply most types of keys depending on vehicle



Key cut prices from £4.25 + vat plus the cost of the key.

We can also re-programme most alarm key fobs too. Prices on request.

Radio codes and emergency key access codes can also be obtained depending on model.

Please contact our sales team on

01522 568000
quoting vehicle details.

RIMMER BROS

PHONE SYSTEM

Our phone system (or 'communication platform' as it is officially known!) speeds up call answering and routing.

The options quickly direct you to the right group of people who can handle your enquiry. Whether an order or customer service issue, you call should be handled quickly and efficiently.

Please note that calls may be recorded for training and for the benefit of our customers.



Who are we?

XPart is today the fastest growing automotive parts marketing and distribution organisation in Europe.

XPart is a division of Caterpillar Logistics UK Ltd and is the continuous driving force for the worldwide sourcing and supply of all MG Rover aftermarket parts.



Availability

XPart has been responsible for the supply of replacement MG Rover parts since 2001 and are committed to the supply of MG Rover parts for the foreseeable future.

6

Simple steps to make it your call!

Close Call

Close Call is a programme aimed at keeping MG Rover vehicles on the road by reviewing parts prices on body and mechanical products, so that repair costs become economically viable.

A programme that will build close working relationships between Insurance Companies, Bodyshops and vehicle repairers to ensure all MG Rover vehicles are kept on the road where possible.

A programme that will guarantee a response turnaround time of 24 hours from receipt of the estimate from the repairer.

Why?

The aim of 'Close Call' is to keep where possible MG Rover vehicles on the road. We have analysed car parc trends and we are determined to keep as many MG Rover vehicles on the road as possible.



When it's a close call Make it your call

Benefits to all

There are clear benefits to all parties involved if we can reduce the number of MG Rovers being declared write offs or scrapped.

Body or Mechanical Repairer -

If we can agree with the Insurance Company or vehicle owner a revised part pricing proposal then the vehicle will be repaired. Via the repair, the bodyshop or mechanical repairer will benefit by providing parts, labour and paint etc. - not possible if the vehicle is written off or scrapped.

Insurance Company -

There are costs behind writing off a vehicle which could be saved.

Customer -

By using 'Close Call' they keep their beloved MG Rover on the road.

XPart -

Keeping MG Rover Vehicles on the road.

1 MG Rover vehicle taken to a nominated Repairer.

The Repairer generates an estimate.

2 The Insurance Company/Vehicle Owner receives the estimate from the Repairer.

If the vehicle is deemed uneconomical to repair, then it's a 'Close Call'.

3 The Repairer contacts the 'Close Call' team.

The Repairer submits a copy of the estimate and a request form to the 'Close Call' team with Pre-Accident Value of the vehicle and parts saving required.

4 The 'Close Call' team review and return revised pricing to the Repairer.

The 'Close Call' team will keep the vehicle on the road where possible. Turnaround time by the 'Close Call' team will be 24 hours.

5 The Insurer/ Vehicle Owner decides whether the vehicle is now economical to repair.

The Repairer contacts the 'Close Call' team with their decision.

6 The 'Close Call' team processes the parts order, with agreed pricing.

Parts are delivered to the nominated Repairer.



New MINI parts

Rimmer Bros now stock a range of Service and Wear parts for the New MINI!



In conjunction with XPart and some of our existing suppliers, we can offer owners a selection of affordable parts and accessories, ideally suited to the DIY owner or for fitment at an independent workshop.

Our range is ever expanding. You will find a list of parts on page 98 (together with prices on page 124 to 151) to cover most of your day to day requirements. For items not listed - please ask!

With over a million cars now on the road, and the oldest models some 9 years old, we believe the demand for parts is very high. Like all the vehicles that Rimmer Bros supply parts for, the New MINI has very British roots (although now owned of course by BMW but produced at Cowley in Oxford) and therefore fits snugly with our 'family' of cars and parts.

Rover in fact, started work on the New MINI back in 1993 which was soon enhanced by the arrival of BMW the following year. The original Mini (which we class as the Rover Mini and already supply parts for) has its origins back in the 50's with Alec Issigonis's first design. It's production continued into the 90's, but with ever increasing EC emission regulations, drive-by noise ratings and impending EuroNCAP crash testing demands, its long-term fate was clear. In addition, the Mini was exceptionally labour intensive and therefore expensive to produce.

It was time for a change.

Rover was working on a replacement for the Metro, so therefore was looking for a new design that would replace both cars. The New MINI was the solution. When BMW bought MG Rover from British Aerospace in 1994, they inherited early designs of the New MINI and allowed Rover to continue on with its development. However, BMW also had some ideas for the New MINI and after many years of development from concept cars in 1997 to the official launch in 2000 (when "Mini" became 'MINI') and finally to its debut on the UK market in July 2001. Since then, this very successful car has been enhanced and developed with many new models and variations. Manufacturing output is now at record levels.

Attractively priced and with strong residual values, the New MINI is a worthy successor to its predecessor.

See page 98 for details on parts available.



MILLTEK SPORT
www.millteksport.com



FOOTMAN JAMES
Insurance specialists. At your service.

0843 357 1769
www.footmanjames.co.uk

All our policies include the following as standard:

- ✓ Motor Legal Expenses
- ✓ 24 hour Breakdown Recovery (UK and European)
- ✓ Personal Accident to include Road Rage & Carjacking
- ✓ Agreed Value, Limited Mileage and Multi-Vehicle options are also available.



From a Midget to a MGB. Whatever your pride and joy, we'll get you covered.

The enthusiasts' favourite for over twenty five years, Footman James is one of the leading specialist insurance brokers.

With a UK client base of 140,000 owners of classic and vintage vehicles, Footman James consistently uses its enormous influence to arrange our best deal for you.

So whatever your pride and joy, you can be confident that with Footman James behind you, you've adopted our best policy.

Talk to us soon.



Quoteline: 0843 357 1769 www.footmanjames.co.uk

Footman James is a trading name of Aon Limited, which is authorised and regulated by the Financial Services Authority in respect of insurance mediation activities only. Telephone calls may be monitored or recorded for your protection.

FP 5012.08.08

COMPETITIVE RATES on modern car, motorcycle, home and contents insurance

GENUINE PARTS & ACCESSORIES



Authorised Land Rover Parts Distributor

Rimmer Bros is an authorised Land Rover Parts Distributor. We offer a full range of genuine Land Rover parts and accessories for all Land Rover vehicles - right up to the latest models!

We also have access to products supplied by Land Rover Classic Parts covering some of the older models.

Please contact us with your requirements.

Counter service, mail order and local trade delivery. Discount for trade (and retail!).





NEWS

LAND ROVER PARTS DEPARTMENT

For fellow Land Rover enthusiasts, we have a dedicated department staffed by people who know your car!

Land Rover Parts Sales: 01522 568000 Option 2
Fax: 01522 567600 E-mail: LRsales@rimmerbros.co.uk

In addition to genuine Land Rover parts, we also offer quality aftermarket parts in certain cases which can often give significant cost savings.

Ask for your free Rimmer Bros catalogue for Range Rover Classic, Series 2 (P38) & 3, Discovery Series 1, 2, 3 & 4, Freelander Series 1 & 2, Defender or Series 2 & 3.

We also stock a comprehensive range of **STAINLESS STEEL EXHAUSTS** for all Land Rover models (including certain sports systems) along with catalyts if required. Powerbox digital engine management upgrades are also available for all Land Rover TD4, TD5, TD6 & TDV6 diesel engines offering improved performance and economy.

Please contact us with your requirements for any Land Rover. Counter service, local trade delivery or mail order. Discount for trade (and retail!).



OUR LAND ROVER CATALOGUES

REQUEST YOUR FREE COPY TODAY



TR2-8, SPITFIRE, GT6, STAG, 2000/2500, HERALD/VITESSE, DOLOMITE/SPRINT.



PARTS DEPARTMENT

We have a dedicated department staffed by people who know your car.

TRIUMPH PARTS SALES: 01522 568000 OPTION 1
E-mail: sales@rimmerbros.co.uk

Please request a **FREE CATALOGUE** for your Triumph or Rover SD1.



BROWSE ALL RIMMER BROS CATALOGUES ON ONE CD! NOW AVAILABLE!

Triumph, Land Rover and our MG Rover Catalogue & Price Guide

Part No. **Cat CD**

FREE TO OWNERS!

FULL RANGE OF PARTS & ACCESSORIES



TRIUMPH PARTS CENTRE

As the World's largest Triumph Parts supplier, Rimmer Bros can offer from stock a broad range of Parts & Accessories for all models 1953 onwards.

Our range of catalogues cover each vehicle in great detail - ask for your free copy.

We have been supplying parts since 1981 and have been British Motor Heritage Approved since 1987.

Counter Service, Mail Order and Local Trade Delivery.



**RIMMER
BROS**

Great British Brands available from



www.rimmerbros.co.uk



Premium products for the Classic Car enthusiast

Rimmer Bros., Triumph House, Sleaford Road, Bracebridge Heath, Lincoln. LN4 2NA. England
Tel +44(0)1522 568000 Fax +44(0)1522 567600 sales@rimmerbros.co.uk

FROM YESTERYEAR TO YESTERDAY

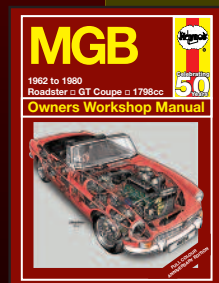
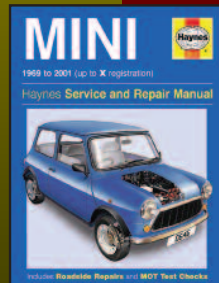
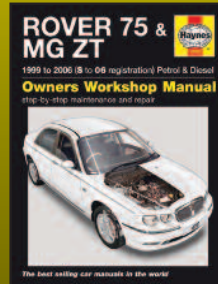
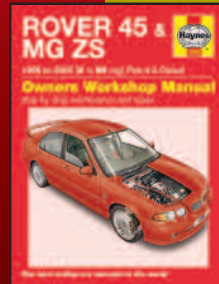
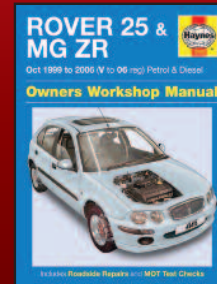
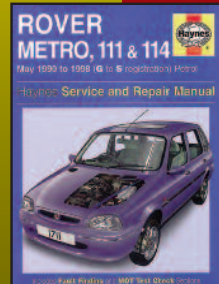
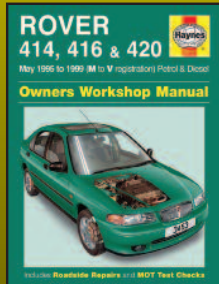
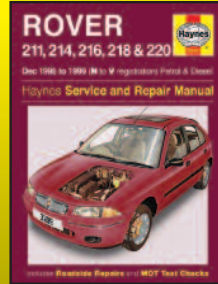
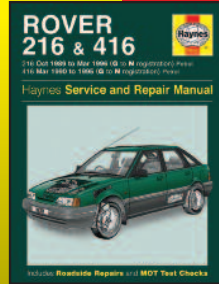

See Haynes See How



MG ROVER CLEARANCE BARGAINS

SAVE UP TO
93%
ON MG ROVER
PRICES!

Pick up a bargain today on these heavily discounted genuine MG Rover parts. First come first served. Limited quantities of product available. Parts will no longer be available when sold. Shipped anywhere worldwide.

Please check our website for latest availability & additional products.

ALL MODELS JUBILEE FLEXDRIVER & CLIP DRIVERS



FLEXDRIVER
RRP ex vat £11.46
SALE PRICE
ex vat inc vat
£6.77 £7.95
Part No. J2FLEXDRIVER



CLIP DRIVER - 160MM LONG
RRP ex vat £11.46
SALE PRICE
ex vat inc vat
£4.25 £4.99
Part No. J2160MM

CLIP DRIVER - 95MM LONG
RRP ex vat £7.48
SALE PRICE
ex vat inc vat
£3.95 £4.64
Part No. J295MM

ALL MODELS INTERIOR CARE XTRA KIT

Includes: rectangular boot mat (rubber), universal rear seat protector & air freshener.



RRP ex vat £19.25
SALE PRICE
ex vat inc vat
£12.72 £14.95
Part No. XPT000139ACA

ALL MODELS LATEX DISPOSABLE GLOVES



ECONOMY GLOVES
RRP ex vat £8.93
SALE PRICE
ex vat inc vat
£3.56 £4.18
Part No. RX1406

ALL MODELS HEADPHONES KIT



RRP ex vat £39.98
SALE PRICE
ex vat inc vat
£21.28 £25.00
Part No. XQM000580

ALL MODELS ESSENTIALS XTRA KIT



Includes: rectangular boot mat (rubber), set (4) dark grey universal floor mats, ice scraper, air freshener & chamois sponge pad.

RRP ex vat £19.43
SALE PRICE
ex vat inc vat
£12.72 £14.95
Part No. XPT000138ACA

ALL MODELS PLASTILUBE ANTI-SQUEAL GREASE



RRP ex vat £11.75
SALE PRICE
ex vat inc vat
£3.36 £3.95
Part No. BAU2138

ALL MODELS TORCH NO BATTERY



RRP ex vat £9.98
SALE PRICE
ex vat inc vat
£2.57 £3.02
Part No. CONS2406

ALL MODELS AIR CON CLEANER



500ML AEROSOL

RRP ex vat £7.98
SALE PRICE
ex vat inc vat
£2.95 £3.47
Part No. S3SGAC1

ALL MODELS CARBAFLO KSP 105 LUBRICANT



STOPS SQUEAKS AND LUBRICATES

100ML AEROSOL
RRP ex vat £25.65
SALE PRICE
ex vat inc vat
£4.25 £4.99
Part No. CYK100070

MGR V8 FRONT LOWER BALL JOINT



RRP ex vat £161.63
SALE PRICE
ex vat inc vat
£63.83 £75.00
Part No. RBK000371EVA

MG ROVER CLEARANCE BARGAINS

SAVE UP TO
93%
ON MG ROVER
PRICES!

Pick up a bargain today on these heavily discounted genuine MG Rover parts.
First come first served. Limited quantities of product available.
Parts will no longer be available when sold. Shipped anywhere worldwide.

Please check our website for latest availability & additional products.

MGF & MG TF

MGF/TF

BARE CYLINDER HEAD

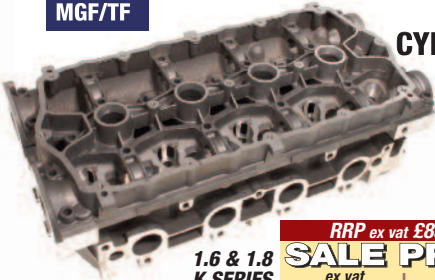

1.6 & 1.8
K SERIES
AUTO TENSIONING
EXCEPT VVC

RRP ex vat £857.70
SALE PRICE
ex vat inc vat
£263.83 £310.00
Part No. LDF109390L

MGF/TF

ELECTRIC DOOR MIRRORS

Door mirrors can be re-painted to suit.
Aerosols available - please enquire.



RRP ex vat £99.88
SALE PRICE
ex vat inc vat
£21.28 £25.00
Part No. CRB110200HFH

RHD/RH
FLAT
ALUMINA GREEN

MGF/TF

XPOWER SPORTSTER HOOD (H.R.W)

1998 ONWARDS



RRP ex vat £613.33
SALE PRICE
ex vat inc vat
£297.87 £350.00
Part Nos.
Yellow - XPT000107FXP
Purple - XPT000107CYP

MGF/TF

FRONT SPARE WHEEL PANEL



RRP ex vat £66.91
SALE PRICE
ex vat inc vat
£25.53 £30.00
Part No. ABB460070



RRP ex vat £99.88
SALE PRICE
ex vat inc vat
£21.28 £25.00
Part No. CRB110170GUF

LHD/LH
CONVEX
SIENNA GOLD



RRP ex vat £99.88
SALE PRICE
ex vat inc vat
£21.28 £25.00
Part No. CRB110200CAQ

RHD/RH
FLAT
NIGHTFIRE RED



RRP ex vat £99.88
SALE PRICE
ex vat inc vat
£21.28 £25.00
Part No. CRB110200NNX

RHD/RH
FLAT
OLD ENGLISH WHITE

MGF/TF

FUEL TANK



RRP ex vat £139.71
SALE PRICE
ex vat inc vat
£80.85 £95.00
Part No. WFE000081

VIN 4D634734

MGF/TF

FUEL FILLER PIPE



RRP ex vat £64.31
SALE PRICE
ex vat inc vat
£12.77 £15.00
Part No. WLP103421

VIN YD522573 ON

LATE MGF & TF

TOP CONSOLE LID ASSEMBLY



RRP ex vat £100.50
SALE PRICE
ex vat inc vat
£29.79 £35.00
Part No. FJB100450SBA

MGF/TF

GEAR LEVER KNOB - LEATHER



RED & BLACK- MGF
RRP ex vat £55.47
SALE PRICE
ex vat inc vat
£20.00 £23.50
Part No. UKJ100370RAK

GREY & BLACK- MGF/TF

RRP ex vat £49.72
SALE PRICE
ex vat inc vat
£20.00 £23.50
Part No. UKJ100370LGB



MGF/TF

SEAL KIT - MANUAL GEARBOX 1800/2000CC



RRP ex vat £33.01
SALE PRICE
ex vat inc vat
£12.77 £15.00
Part No. TRT100050

MGF/TF

HEATER ASSEMBLY



RRP ex vat £330.05
SALE PRICE
ex vat inc vat
£165.96 £195.00
Part Nos.
MGF - JEC102220
MG TF - JEC000940

MGF

ENGINE INTAKE DUCT RETAINER LH



RRP ex vat £16.74
SALE PRICE
ex vat inc vat
£6.38 £7.50
Part No. DHS100030

MG TF

THROTTLE BODY ASSEMBLY PLASTIC BODY



RRP ex vat £281.42
SALE PRICE
ex vat inc vat
£63.83 £75.00
Part No. MHB102141

MG ROVER CLEARANCE BARGAINS

SAVE UPTO
93%
ON MG ROVER
PRICES!

Pick up a bargain today on these heavily discounted genuine MG Rover parts.
First come first served. Limited quantities of product available.
Parts will no longer be available when sold. Shipped anywhere worldwide.

Please check our website for latest availability & additional products.

MG ZR INSTRUMENT PACKS



RRP ex vat £123.43
SALE PRICE
ex vat inc vat
£34.04 £40.00
Part No. YAC001260PMP
KPH
1800 MANUAL,
WITH ABS, EXC VVC
VIN 1D548250 TO



RRP ex vat £132.34
SALE PRICE
ex vat inc vat
£34.04 £40.00
Part No. YAC001310PMP
MPH
2.0 DIESEL MANUAL, WITH
ABS, TO VIN 4D779020



RRP ex vat £134.78
SALE PRICE
ex vat inc vat
£34.04 £40.00
Part No. YAC001320PMP
KPH
2.0 DIESEL MANUAL, WITH
ABS, TO VIN 4D779020



RRP ex vat £89.00
SALE PRICE
ex vat inc vat
£34.04 £40.00
Part No. YAC003450PMP
MPH
1800 AUTO,
WITH ABS,
VIN 2D641741 TO 4D77902

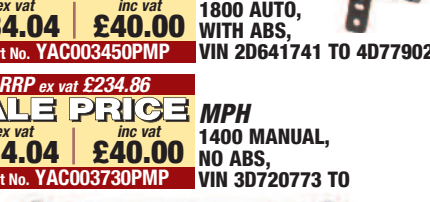

RRP ex vat £234.86
SALE PRICE
ex vat inc vat
£34.04 £40.00
Part No. YAC003730PMP
MPH
1400 MANUAL,
NO ABS,
VIN 3D720773 TO



RRP ex vat £300.43
SALE PRICE
ex vat inc vat
£34.04 £40.00
Part No. YAC004910PMP
KPH
2.0 DIESEL MANUAL
WITH EBD & ABS
VIN 5D779021 ON

RRP ex vat £295.79
SALE PRICE
ex vat inc vat
£34.04 £40.00
Part No. YAC004670PMP
KPH
2.0 DIESEL WITH EBD,
ABS, VIN 5D779021 ON

INSTRUMENT PACKS

When ordering, please double check your application with our sales team to ensure correct unit is purchased.

ROVER 25 INSTRUMENT PACKS



RRP ex vat £130.43
SALE PRICE
ex vat inc vat
£34.04 £40.00
Part No. YAC000240PMP
MPH
2.0 DIESEL MANUAL,
EXCLUDING ABS
VIN 1D548250 TO
3D686032

RRP ex vat £273.43
SALE PRICE
ex vat inc vat
£34.04 £40.00
Part No. YAC004860PMP
MPH
1800 AUTO WITH EBD,
ABS, VIN 5D779021 ON



RRP ex vat £313.81
SALE PRICE
ex vat inc vat
£34.04 £40.00
Part No. YAC001800PMP
MPH
1600/1800 AUTO,
VIN 1D548250
TO 3D686032

RRP ex vat £132.34
SALE PRICE
ex vat inc vat
£34.04 £40.00
Part No. YAC000180PMP
MPH
1800 AUTO,
NO ABS,
FROM VIN 1D548250



RRP ex vat £132.34
SALE PRICE
ex vat inc vat
£34.04 £40.00
Part No. YAC001840PMP
MPH
DIESEL MANUAL,
WITH ABS, VIN 1D548250
TO 3D686032

RRP ex vat £89.88
SALE PRICE
ex vat inc vat
£34.04 £40.00
Part No. YAC003530PMP
MPH
1600/1800 AUTO,
VIN 2D641741 TO
3D686032

STREETWISE INSTRUMENT PACKS



RRP ex vat £202.49
SALE PRICE
ex vat inc vat
£34.04 £40.00
Part No. YAC004040
MPH
PETROL AUTO
ABS VIN 4D733154 TO
4D778996, BLUE DIALS

RRP ex vat £138.97
SALE PRICE
ex vat inc vat
£34.04 £40.00
Part No. YAC004780PMP
MPH
MANUAL DIESEL WITH
ABS, VIN 5D778997 ON
BLUE DIALS



RRP ex vat £198.75
SALE PRICE
ex vat inc vat
£34.04 £40.00
Part No. YAC004070
KPH
DIESEL MANUAL
NON ABS
VIN 4D733154 TO
4D778996, BLUE DIALS

RRP ex vat £196.00
SALE PRICE
ex vat inc vat
£34.04 £40.00
Part No. YAC004010
KPH
MANUAL PETROL
NON ABS,
VIN 4D733154 TO
4D778996, BLUE DIALS



RRP ex vat £134.27
SALE PRICE
ex vat inc vat
£34.04 £40.00
Part No. YAC004790PMP
KPH
DIESEL MANUAL ABS
VIN 5D778997 ON
BLUE DIALS

ROVER 25 / MG ZR SPEEDOMETER

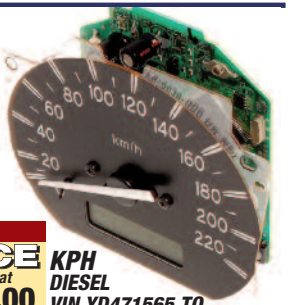

RRP ex vat £94.86
SALE PRICE
ex vat inc vat
£34.04 £40.00
Part No. YBC101730
KPH
DIESEL
VIN YD471565 TO
1D548249



MG ROVER CLEARANCE BARGAINS

SAVE UP TO
93%
ON MG ROVER
PRICES!

Pick up a bargain today on these heavily discounted genuine MG Rover parts.
First come first served. Limited quantities of product available.
Parts will no longer be available when sold. Shipped anywhere worldwide.

Please check our website for latest availability & additional products.

MG ZR, ROVER 25 & STREETWISE

ROVER 25 **1400 16V K SERIES ENGINE**



RRP ex vat £2615.78
SALE PRICE
ex vat inc vat
£1200.00 £1410.00
Part No. LBB002450ASSY

IB5 GEARBOX
VIN 3D720773 ON

ROVER 25
STARTER MOTOR



RRP ex vat £150.44
SALE PRICE
ex vat inc vat
£80.85 £95.00
Part No. NAD101260 NEW T-O

1100/1400/1600

ROVER 25
ENGINE MOUNTING



1100/1400/1600
VIN YD600076 ON

RRP ex vat £67.08
SALE PRICE
ex vat inc vat
£21.28 £25.00
Part No. KKB101550

ROVER 25
ARM ASSEMBLY - ENGINE MOUNTING



1100/1400/1600
IB5 GEARBOX
VIN 3D720773 ON

RRP ex vat £41.85
SALE PRICE
ex vat inc vat
£21.28 £25.00
Part No. KKK000940 NEW T-O

ROVER 25
POWER STEERING RACKS



RRP ex vat £533.13
SALE PRICE
ex vat inc vat
£106.38 £125.00
Part No. QAB102961

RHD
VIN YD471565 ON
EXCEPT 16" & 17" WHEELS

ROVER 25 / 200
ENGINE ASSEMBLY - DIESEL

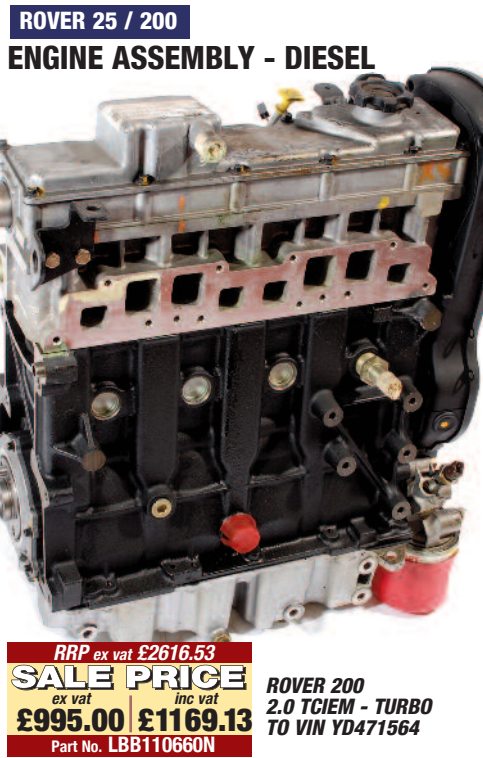

RRP ex vat £2616.53
SALE PRICE
ex vat inc vat
£995.00 £1169.13
Part No. LBB110660N

ROVER 200
2.0 TCIEM - TURBO
TO VIN YD471564

ROVER 25
FUEL PUMP

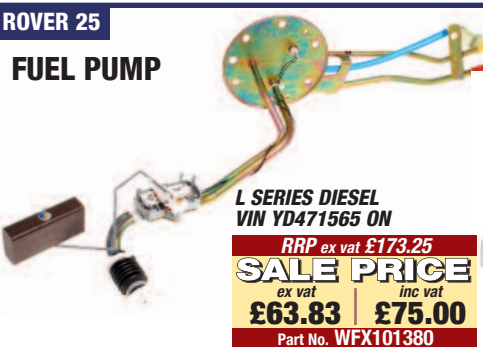

L SERIES DIESEL
VIN YD471565 ON

RRP ex vat £173.25
SALE PRICE
ex vat inc vat
£63.83 £75.00
Part No. WFX101380

ROVER 25
THROTTLE BODY ASSEMBLY



RRP ex vat £281.42
SALE PRICE
ex vat inc vat
£63.83 £75.00
Part No. MHB102141

PLASTIC BODY

MGZR & ROVER 25/200 **BARE CYLINDER HEAD**

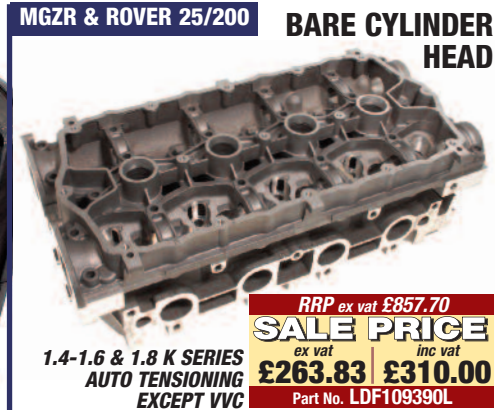

RRP ex vat £857.70
SALE PRICE
ex vat inc vat
£263.83 £310.00
Part No. LDF109390L

1.4-1.6 & 1.8 K SERIES
AUTO TENSIONING
EXCEPT VVC

ROVER 25 / 200
ACOUSTIC ENGINE COVER



RRP ex vat £55.90
SALE PRICE
ex vat inc vat
£21.28 £25.00
Part No. LBH100330

ROVER 200
2 LITRE DIESEL
WITHOUT INTERCOOLER

ROVER 25 / MG ZR **IB5 GEARBOX**



1400 16V
VIN 3D720773 ON

RRP ex vat £1375.36
SALE PRICE
ex vat inc vat
£382.98 £450.00
Part No. TRC000380 NEW T-O

ROVER 200/25 & MG ZR
HEATER ASSEMBLY



RRP ex vat £226.04
SALE PRICE
ex vat inc vat
£63.83 £75.00
Part No. JEC102080

OUTRIGHT SALE



RRP ex vat £192.74
SALE PRICE
ex vat inc vat
£106.38 £125.00
Part No. QAB102730E

LHD
ROVER 200 BRM
TO VIN 471564

MG ROVER CLEARANCE BARGAINS

SAVE UP TO
93%
ON MG ROVER
PRICES!

Pick up a bargain today on these heavily discounted genuine MG Rover parts. First come first served. Limited quantities of product available. Parts will no longer be available when sold. Shipped anywhere worldwide.

Please check our website for latest availability & additional products.

ROVER 25 / MG ZR
BODY SIDE



RRP ex vat £396.50
SALE PRICE
ex vat inc vat
£106.38 £125.00
Part No. ALA450540
LH 5 DOOR

MG ZR FRONT BIB SPOILER



RRP ex vat £195.00
SALE PRICE
ex vat inc vat
£93.61 £109.99
Part No. DFB100590LML
MK1

ROVER 25 TAILGATE SPOILER



RRP ex vat £282.62
SALE PRICE
ex vat inc vat
£63.83 £75.00
Part No. DFD000020LML
1 ONLY
PRIMED

ROVER 25 GLOVE BOX LID BUFFER



RRP ex vat £1.38
SALE PRICE
ex vat inc vat
£0.21 £0.25
Part No. FFP100080

ROVER 25/200 BUMPER ASSEMBLY, REAR - BROOKLANDS GREEN



CAN BE RE-PAINTED

RRP ex vat £379.73
SALE PRICE
ex vat inc vat
£80.85 £95.00
Part No. DQB102410WAI

REDUCED

ROVER 25 SUN ROOF WIND DEFLECTOR



RRP ex vat £42.66
SALE PRICE
ex vat inc vat
£17.02 £20.00
Part No. EFJ100180

ROVER 25 / MG ZR BONNET BUFFER



VIN YD471565 ON

RRP ex vat £1.17
SALE PRICE
ex vat inc vat
£0.81 £0.95
Part No. CJM100180

ROVER 25 / MG ZR EXTERIOR TRIM KIT 4 ARCHES



RRP ex vat £88.60
SALE PRICE
ex vat inc vat
£34.04 £40.00
Part No. VUB002660PMA

ROVER 25 / MG ZR GLASS ASSEMBLY FRONT DOOR



RH 3 DOOR GREEN

RRP ex vat £115.63
SALE PRICE
ex vat inc vat
£34.04 £40.00
Part No. CUB000220

ROVER 25 / MG ZR HEADLAMP LEVELLING SWITCH



FROM VIN 5D778997

RRP ex vat £27.11
SALE PRICE
ex vat inc vat
£8.51 £10.00
Part No. YUT000020PMP

ROVER 25 GEAR LEVER KNOB



1400/1600 R65 GEARBOX

RRP ex vat £67.17
SALE PRICE
ex vat inc vat
£17.02 £20.00
Part No. UKJ000110PMA

MG ZR TAILGATE HANDLE



TO VIN 3D698205 ANTHRACITE

RRP ex vat £128.09
SALE PRICE
ex vat inc vat
£34.04 £40.00
Part No. CXB000200LQW

ROVER 25 14" ALLOY ROAD WHEEL VOODOO STYLE 6.0J X 14" SILVER SPARKLE



RRP ex vat £159.76
SALE PRICE
ex vat inc vat
£42.55 £50.00
Part No. RRC117270MNH

ROVER 25/ MG ZR M3 MIRROR MOUNTING BRACKETS (PAIR)



RRP ex vat £10.59
SALE PRICE
ex vat inc vat
£4.25 £4.99
Part No. XPT000036ACA

ROVER 25 TAILGATE HANDLE



FROM VIN YD471565 TAHITI BLUE

RRP ex vat £97.74
SALE PRICE
ex vat inc vat
£25.53 £30.00
Part No. CXB108170JAO

ROVER 200/25/MG ZR ROVER 400/45/MG ZS STEEL SPACE SAVER ROAD WHEEL 16" x 4J



RRP ex vat £75.72
SALE PRICE
ex vat inc vat
£21.27 £24.99
Part No. RRC116520PMN

ROVER 25 HEADLAMP PROTECTOR



RRP ex vat £34.00
SALE PRICE
ex vat inc vat
£8.51 £10.00
Part No. XPT000113ACA

ROVER 25 FRONT DOOR LATCH



LH/LHD 3 DOOR VIN YD471565 TO 3D671762 MANUAL LOCKS

RRP ex vat £93.94
SALE PRICE
ex vat inc vat
£25.53 £30.00
Part No. FQJ103690PMA

ROVER 25 / MG ZR ROAD WHEEL FITTING KIT VOODOO STYLE WHEELS



RRP ex vat £102.97
SALE PRICE
ex vat inc vat
£25.53 £30.00
Part No. RRB100540

MG ROVER CLEARANCE BARGAINS

SAVE UP TO
93%
ON MG ROVER
PRICES!

Pick up a bargain today on these heavily discounted genuine MG Rover parts.
First come first served. Limited quantities of product available.
Parts will no longer be available when sold. Shipped anywhere worldwide.

Please check our website for latest availability & additional products.

MG ZR, ROVER 25 & STREETWISE

ROVER 25/200

FRONT WINDSCREEN WIPER ARM



LHD - LH

RRP ex vat £17.49
SALE PRICE
ex vat inc vat
£6.38 £7.50
Part No. DKB102210

ROVER 25

HANDBOOK

VIN 778997 ON
ITALIAN OR PORTUGUESE



RRP ex vat £27.81
SALE PRICE
ex vat inc vat
£10.00 £10.00
Part Nos.
ITALIAN VDC0005801IT
PORTUGUESE VDC0005801PT

STREETWISE

HANDBOOK

VIN 778997 ON
2004 ON - FRENCH

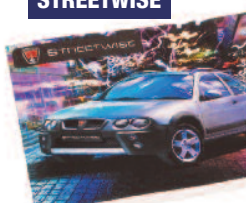

RRP ex vat £31.74
SALE PRICE
ex vat inc vat
£10.00 £10.00
Part No. VDC000620FR

ROVER 25

CD AUTO-CHANGER



RRP ex vat £363.22
SALE PRICE
ex vat inc vat
£42.55 £50.00
Part No. XQE000110PMP

6 DISC

STREETWISE REAR MUDFLAP KIT

PAIR



RRP ex vat £21.89
SALE PRICE
ex vat inc vat
£8.47 £9.95
Part No. CAT000380LNF

ROVER 25 - VAN

LOAD SPACE CARPET



RRP ex vat £82.57
SALE PRICE
ex vat inc vat
£34.04 £40.00
Part No. EAG000180LNF

ASH GREY
VIN 3D701046 ON

ROVER 25/200

OVERMAT SETS



RHD
SANDSTONE BEIGE

RRP ex vat £42.51
SALE PRICE
ex vat inc vat
£8.51 £10.00
Part No. EAH105300SCD



LHD
ASH GREY

RRP ex vat £27.95
SALE PRICE
ex vat inc vat
£8.51 £10.00
Part No. EAH105290LNF



PREMIUM QUALITY

RRP ex vat £49.38
SALE PRICE
ex vat inc vat
£10.64 £12.50
Part No. EAH1052900SCD

LHD
SANDSTONE BEIGE



PREMIUM QUALITY

SMOKESTONE

RRP ex vat £52.63
SALE PRICE
ex vat inc vat
£10.64 £12.50
Part No. EAH103070LPR

LHD
ROVER 200 1995
TO VIN YD471564



RRP ex vat £14.56

SALE PRICE
ex vat inc vat
£8.51 £10.00
Part No. EAH102960LPR

LHD
ROVER 200
1995
TO VIN YD471564
SMOKESTONE



RHD
ROVER 200
1995
TO VIN YD471564
SMOKESTONE

RRP ex vat £14.00
SALE PRICE
ex vat inc vat
£8.51 £10.00
Part No. EAH102930LPR

STREETWISE

FLOOR MAT SET



RRP ex vat £33.59
SALE PRICE
ex vat inc vat
£8.51 £10.00
Part No. XPT00033ACA

RHD - BLACK

STREETWISE

FRONT RUBBER MATS



RRP ex vat £12.19
SALE PRICE
ex vat inc vat
£4.26 £5.00
Part No. XPT00038ACA

LHD - GREY

ROVER 25 - VAN

RIGID LOAD SPACE LINER



RRP ex vat £120.91
SALE PRICE
ex vat inc vat
£42.55 £50.00
Part No. EBF000050



COULD BE MODIFIED / CUT TO FIT RHD

RRP ex vat £18.63
SALE PRICE
ex vat inc vat
£6.81 £8.00
Part No. XPT00034ACA

MG ROVER CLEARANCE BARGAINS

SAVE UP TO
93%
ON MG ROVER
PRICES!

Pick up a bargain today on these heavily discounted genuine MG Rover parts.
First come first served. Limited quantities of product available.
Parts will no longer be available when sold. Shipped anywhere worldwide.

Please check our website for latest availability & additional products.

ROVER 45 **1400 16V K SERIES ENGINE**



RRP ex vat £2615.78
SALE PRICE
ex vat inc vat
£1200.00 £1410.00
Part No. LBB002450

IB5 GEARBOX
VIN 3D618246 ON

ROVER 400 **ENGINE ASSEMBLY - DIESEL**



RRP ex vat £2616.53
SALE PRICE
ex vat inc vat
£995.00 £1169.13
Part No. LBB110660N

ROVER 400
2.0 TCIEM - TURBO
TO VIN YD4711063

ROVER 45 / MG ZS **STEERING WHEEL ASSEMBLY**



RRP ex vat £250.10
SALE PRICE
ex vat inc vat
£42.55 £50.00
Part No. QTB001230PMA

SOFT FEEL BLACK LEATHER WITH CRUISE & ICE REMOTE

RRP ex vat £152.74
SALE PRICE
ex vat inc vat
£42.55 £50.00
Part No. QTB103591PMA

BLACK LEATHER CD AUTOCHANGER WITH ICE CONTROLS - NO CRUISE CONTROL

ROVER 45 / MGZS **OIL SUMP ASSEMBLY**



RRP ex vat £113.87
SALE PRICE
ex vat inc vat
£42.55 £50.00
Part No. LSB102860

2000/2500 V6

ROVER 45/400 & MG ZS **BARE CYLINDER HEAD**



RRP ex vat £857.70
SALE PRICE
ex vat inc vat
£263.83 £310.00
Part No. LDF109390L

1.4-1.6 & 1.8 K SERIES
AUTO TENSIONING
EXCEPT VVC

ROVER 45/400 & MG ZS **POWER STEERING RACKS**



RRP ex vat £209.13
SALE PRICE
ex vat inc vat
£106.38 £125.00
Part No. QEB100421E

RHD
VIN YD471064 TO
3D603410
2.0 V6

RRP ex vat £220.78
SALE PRICE
ex vat inc vat
£106.38 £125.00
Part No. QEB100142E

RHD
ROVER 400
TO VIN YD471063
1.4/1.6 EXCEPT 6.0 X
15" WHEELS

ROVER 45 **STARTER MOTOR**
1100/1400/1600



RRP ex vat £150.44
SALE PRICE
ex vat inc vat
£80.85 £95.00
Part No. NAD101260 NEW T-O

ROVER 400 **ACOUSTIC ENGINE COVER**



RRP ex vat £55.90
SALE PRICE
ex vat inc vat
£21.28 £25.00
Part No. LBH100330

2 LITRE DIESEL
WITHOUT INTERCOOLER

ROVER 45/ MG ZS **FUEL TANK**



RRP ex vat £254.78
SALE PRICE
ex vat inc vat
£59.57 £69.99
Part No. WFE107272

DIESEL
VIN 3D613347 ON

ROVER 45 **THROTTLE BODY ASSEMBLY**



RRP ex vat £281.42
SALE PRICE
ex vat inc vat
£63.83 £75.00
Part No. MHB102141

PLASTIC BODY

ROVER 45 / MG ZS **ACCELERATOR CABLES**



RRP ex vat £76.00
SALE PRICE
ex vat inc vat
£12.77 £15.00
Part No. SBB103630

RHD - 95 ON
NOT CRUISE CONTROL

ROVER 400 **REAR EXHAUSTS**



RRP ex vat £83.45
SALE PRICE
ex vat inc vat
£34.04 £40.00
Part No. WCG102410

2.0 PETROL
5 DOOR MANUAL TO
VIN AD250028

ROVER 400 **ENGINE MOUNTING RUBBER**



RRP ex vat £34.61
SALE PRICE
ex vat inc vat
£12.77 £15.00
Part No. KKB101500

1.6 AUTO HONDA SOHC

ROVER 45 / MG ZS **DRIVESHAFT**
1400/1600
95 TO VIN 3D618245



RRP ex vat £232.01
SALE PRICE
ex vat inc vat
£72.34 £85.00
Part No. TDC000060

ROVER 45 **TAILPIPE FINISHER**
DIESEL



RRP ex vat £39.37
SALE PRICE
ex vat inc vat
£17.02 £20.00
Part No. DUB000060MMM

ROVER 45 / MG ZS **DRIVE PLATE**
KV6



RRP ex vat £271.05
SALE PRICE
ex vat inc vat
£63.83 £75.00
Part No. TPB100210

ROVER 45 / MG ZS **DRIVE PLATE**
KV6



RRP ex vat £271.05
SALE PRICE
ex vat inc vat
£63.83 £75.00
Part No. TPB100210

LHD - 95 ON
RRP ex vat £20.75
SALE PRICE
ex vat inc vat
£10.64 £12.50
Part No. SBB103550

MG ROVER CLEARANCE BARGAINS

SAVE UP TO
93%
ON MG ROVER
PRICES!

Pick up a bargain today on these heavily discounted genuine MG Rover parts.
First come first served. Limited quantities of product available.
Parts will no longer be available when sold. Shipped anywhere worldwide.

Please check our website for latest availability & additional products.

MG ZS & ROVER 45/400

ROVER 45/400

WINDSCREEN - TINTED

FROM VIN 4D621723

RRP ex vat £220.71
SALE PRICE
ex vat inc vat
£42.55 £50.00

Part No. CMB000620

ROVER 45

TAILGATE ASSEMBLY

PAINTED VIN 5D637209 ON WITH SPOILER

RRP ex vat £295.00
SALE PRICE
ex vat inc vat
£127.66 £150.00

Part No. BHA160180SLP

MG ZS 180

REAR BUMPER ASSEMBLY

RRP ex vat £185.71
SALE PRICE
ex vat inc vat
£106.38 £125.00

Part No. DQB001830LML

PARKING AID PLUS EXHAUST FINISHER TYPE

ROVER 45/400 & MG ZS

BOOT SPOILER

RRP ex vat £230.17
SALE PRICE
ex vat inc vat
£63.83 £75.00

Part No. DFD101690LQW

ANTHRACITE

ROVER 45

SUN ROOF WIND DEFLECTOR

RRP ex vat £42.66
SALE PRICE
ex vat inc vat
£17.02 £20.00

Part No. EFJ100180

MG ZS

REAR BODY SIDE

LH 4 DOOR VIN 5D637209 ON

RRP ex vat £275.75
SALE PRICE
ex vat inc vat
£106.38 £125.00

Part No. ALA160410

MG ZS

FACIA ASSEMBLY

RHD VIN 3D603411 TO 5D637208 DRIVER & PASSENGER AIR BAG

RRP ex vat £480.97
SALE PRICE
ex vat inc vat
£106.38 £125.00

Part No. FAB001280PPA

ROVER 45 / MG ZS

LH FRONT DOOR GLASS

FROM VIN YD549580

RRP ex vat £133.92
SALE PRICE
ex vat inc vat
£10.64 £12.50

Part No. CUB000130

ROVER 45

BEAM ASSEMBLY SUBFRAME

1.8 PETROL MANUAL & AUTO / 2.0 DIESEL MANUAL/KV6 AUTO VIN YD471064 TO 3D618245

RRP ex vat £241.71
SALE PRICE
ex vat inc vat
£106.38 £125.00

Part No. KGC106460

MG ZS

FRONT WING - LH

BODYKIT OPTION - FROM VIN 5D637209

RRP ex vat £113.60
SALE PRICE
ex vat inc vat
£42.55 £50.00

Part No. ASB160030

ROVER 45 / MG ZS

WINDOW REGULATORS

LH REAR ROVER 45 & MG ZS

RRP ex vat £216.25
SALE PRICE
ex vat inc vat
£63.83 £75.00

Part No. CVH106370

ROVER 45 / MG ZS

WINDOW REGULATORS

RH REAR ROVER 400/45

RRP ex vat £98.28
SALE PRICE
ex vat inc vat
£21.28 £25.00

Part No. CVH101080

ROVER 45 / MG ZS

DOOR ACTUATOR & LATCH ASSEMBLY

LH FRONT 1995 TO VIN WD354434

RRP ex vat £227.55
SALE PRICE
ex vat inc vat
£42.55 £50.00

Part No. FUB102760

MG ZS

LICENCE PLATE APPLIQUE

RRP ex vat £87.74
SALE PRICE
ex vat inc vat
£42.55 £50.00

Part No. DRP000010FAR

TROPHY YELLOW 5 DOOR

MG ZS

DOOR HANDLES

LH FRONT LH COPPERLEAF

RH REAR BRITISH RACING GREEN 3

RH REAR TAHITI BLUE

RRP ex vat £51.88
SALE PRICE
ex vat inc vat
£21.28 £25.00

Part No. CXB000150CDX
CXB000180HFF
CXB000180JRJ

MG ZS

DOOR HANDLES

RH REAR BRITISH RACING GREEN 3

RH REAR TAHITI BLUE

RRP ex vat £51.88
SALE PRICE
ex vat inc vat
£21.28 £25.00

Part No. CXB000150CDX
CXB000180HFF
CXB000180JRJ

ROVER 45 / MG ZS

FRONT WINDOW SWITCH PACK

VIN 3D612918 ON

RRP ex vat £29.10
SALE PRICE
ex vat inc vat
£12.77 £15.00

Part No. YUD000660PMP

MG ZS

LOCK SET

LHD TO VIN 3D612917

RRP ex vat £222.23
SALE PRICE
ex vat inc vat
£80.85 £95.00

Part No. CWB000890

MG ZS

FRONT UPPER ARM

VIN YD553742 ON

RRP ex vat £82.42
SALE PRICE
ex vat inc vat
£34.04 £40.00

Part No. RBJ000500

ROVER 400/45

REAR TRAILING ARM BUSH 95 ON

RRP ex vat £16.68
SALE PRICE
ex vat inc vat
£4.25 £4.99

Part No. RGX000770

ROVER 400 / 45

BOOT LID BUFFER

4 DOOR

RRP ex vat £0.81
SALE PRICE
ex vat inc vat
£0.42 £0.49

Part No. CJM000050

ROVER 45 / MG ZS

BOOT HINGES

RRP ex vat £25.10
SALE PRICE
ex vat inc vat
£17.02 £20.00

Part Nos. RIGHT HAND BMB160020 LEFT HAND BMB160030

ROVER 45 / MG ZS

SEAL KIT

MANUAL GEARBOX 1800/2000

RRP ex vat £33.01
SALE PRICE
ex vat inc vat
£12.77 £15.00

Part No. TRT100050

ROVER 400/45

GRILLE BADGE

RRP ex vat £8.93
SALE PRICE
ex vat inc vat
£4.25 £4.99

Part No. DAB101690

MG ROVER CLEARANCE BARGAINS

SAVE UP TO
93%
ON MG ROVER
PRICES!

Pick up a bargain today on these heavily discounted genuine MG Rover parts.
First come first served. Limited quantities of product available.
Parts will no longer be available when sold. Shipped anywhere worldwide.

Please check our website for latest availability & additional products.

ROVER 45 INSTRUMENT PACKS



RRP ex vat £123.43
SALE PRICE
ex vat inc vat
£34.04 £40.00
Part No. YAC001900PMP
KPH
1400/1600 MANUAL
SOUTH AMERICA



RRP ex vat £197.05
SALE PRICE
ex vat inc vat
£34.04 £40.00
Part No. YAC003250PMP
MPH
1400/1600
VIN 3D596955 TO
3D603411



RRP ex vat £128.37
SALE PRICE
ex vat inc vat
£34.04 £40.00
Part No. YAC001920PMP
MPH
1800 MANUAL
TO VIN 3D596954



RRP ex vat £123.43
SALE PRICE
ex vat inc vat
£34.04 £40.00
Part No. YAC001940PMP
KPH
1800 MANUAL
SOUTH AMERICA



RRP ex vat £315.66
SALE PRICE
ex vat inc vat
£34.04 £40.00
Part No. YAC002080PMP
MPH
2.0 V6
TO VIN 3D603410
WITH EBD



RRP ex vat £198.01
SALE PRICE
ex vat inc vat
£34.04 £40.00
Part No. YAC003310PMP
MPH
1800 AUTO
VIN 3D596955 TO
3D603411



RRP ex vat £218.14
SALE PRICE
ex vat inc vat
£34.04 £40.00
Part No. YAC001980PMP
KPH
1800 AUTO
SOUTH AMERICA



RRP ex vat £128.37
SALE PRICE
ex vat inc vat
£34.04 £40.00
Part No. YAC002060PMP
KPH
V6 WITH EBD
TO VIN 3D596954
BLACK

MG ZS INSTRUMENT PACKS

When ordering, please double check your application with our sales team to ensure correct unit is purchased.



RRP ex vat £229.68
SALE PRICE
ex vat inc vat
£34.04 £40.00
Part No. YAC004540PMP
MPH
2.0 DIESEL,
VIN 5D637209 ON



RRP ex vat £322.36
SALE PRICE
ex vat inc vat
£34.04 £40.00
Part No. YAC001360PMP
KPH
1600
VIN YD553742 TO
3D596954



RRP ex vat £245.06
SALE PRICE
ex vat inc vat
£42.55 £50.00
Part No. YAC004560PMP
MPH
2.5 KV6
FROM VIN 5D637209

ROVER 45 / MG ZS INSTRUMENT PACKS



RRP ex vat £343.03
SALE PRICE
ex vat inc vat
£34.04 £40.00
Part No. YAC004410PMP
KPH
2.0 DIESEL,
VIN 5D637209 ON



RRP ex vat £128.37
SALE PRICE
ex vat inc vat
£34.04 £40.00
Part No. YAC002060PMP
KPH
V6 WITH EBD
TO VIN 3D596954
BLACK

ROVER 45/400/ & MG ZS GEAR LEVER GAITER & FINISHER



RHD AUTO
RRP ex vat £37.39
SALE PRICE
ex vat inc vat
£8.51 £10.00
Part Nos.
TECHNIK 1/BLACK FJV107000MVT
ROSEWOOD FJV107000AFM



LHD AUTO
VIN 5D637209 ON
RRP ex vat £45.22
SALE PRICE
ex vat inc vat
£4.26 £5.00
Part No. FJL000810LFD



LHD/RHD AUTO
VIN 5D637209 ON
RRP ex vat £39.45
SALE PRICE
ex vat inc vat
£12.77 £15.00
Part Nos.
LHD - BURR WALNUT
FJL000770ANV
RHD - BLACK OAK
FJL000760PWI



LHD MANUAL
VIN 5D637209 ON
RRP ex vat £53.57
SALE PRICE
ex vat inc vat
£12.77 £15.00
Part Nos.
LIGHT OAK FJL000750AGC
BLACK OAK FJL000750PWI



RHD MANUAL
TO VIN AD1167920
5 DOOR EXCEPT 2000cc
RRP ex vat £38.20
SALE PRICE
ex vat inc vat
£12.77 £15.00
Part No. FJL100570PMP



RHD/LHD
TO VIN YD471063
BLACK
RRP ex vat £44.45
SALE PRICE
ex vat inc vat
£12.77 £15.00
Part Nos.
RHD - FJL100750PMP
LHD - FJL100760PMP

ROVER 400



ROVER 400
AUBERGINE
LEATHER
RRP ex vat £37.93
SALE PRICE
ex vat inc vat
£17.02 £20.00
Part No. UKJ100421KMW

MG ROVER CLEARANCE BARGAINS

SAVE UP TO
93%
ON MG ROVER
PRICES!

Pick up a bargain today on these heavily discounted genuine MG Rover parts.
First come first served. Limited quantities of product available.
Parts will no longer be available when sold. Shipped anywhere worldwide.

Please check our website for latest availability & additional products.

ROVER 45/400

OVERMAT SETS



RHD SANDSTONE BEIGE

RRP ex vat £42.51
SALE PRICE
ex vat inc vat
£8.51 £10.00
Part No. EAH105360SCD



RHD NEPTUNE BLUE

RRP ex vat £51.35
SALE PRICE
ex vat inc vat
£10.64 £12.50
Part No. EAH105360JEX



LHD COPPER BEECH

RRP ex vat £47.37
SALE PRICE
ex vat inc vat
£8.51 £10.00
Part No. EAH105370CBA



LHD NEPTUNE BLUE

RRP ex vat £49.38
SALE PRICE
ex vat inc vat
£10.64 £12.50
Part No. EAH105370JEX



RHD COPPERBEECH

RRP ex vat £49.26
SALE PRICE
ex vat inc vat
£10.64 £12.50
Part No. EAH105360CBA

PREMIUM QUALITY



LHD ASH GREY

RRP ex vat £25.52
SALE PRICE
ex vat inc vat
£10.64 £12.50
Part No. EAH105370LNF



RHD ROVER 400 1995 ON BEIGE

RRP ex vat £21.26
SALE PRICE
ex vat inc vat
£10.64 £12.50
Part No. EAH103400SMJ

PREMIUM QUALITY



LHD BEIGE

RRP ex vat £49.38
SALE PRICE
ex vat inc vat
£10.64 £12.50
Part No. EAH105370SCD

ROVER 45

PARCEL SHELF ASSEMBLY



4 DOOR REAR END TRIM

RRP ex vat £52.95
SALE PRICE
ex vat inc vat
£17.02 £20.00
Part No. EPB100900LNF

ROVER 45 / MG ZS

HEADLAMP PROTECTOR



FROM VIN 637209

RRP ex vat £28.32
SALE PRICE
ex vat inc vat
£12.55 £14.75
Part No. XPT000112ACA

MG ZS RUBBER FLOOR MATS



REAR - BLACK

RRP ex vat £25.00
SALE PRICE
ex vat inc vat
£6.81 £8.00
Part No. EAH000530PMA



FRONT LHD - BLACK
VIN YD556742 TO 3D612917

RRP ex vat £25.00
SALE PRICE
ex vat inc vat
£8.51 £10.00
Part No. EAH000170PMA



FRONT RHD - BLACK
VIN 3D612918 ON

RRP ex vat £28.98
SALE PRICE
ex vat inc vat
£8.51 £10.00
Part No. EAH000910PMA

ROVER 45 / MG ZS

REAR MUDFLAP KIT



RRP ex vat £22.56
SALE PRICE
ex vat inc vat
£8.51 £10.00

REAR PAIR
4 DOOR FACELIFT MODELS
Part No. XPT000110ACA

ROVER 45 / MG ZS

ALLOY ROAD WHEEL



SILVER SPARKLE 5 SPOKE

6.0 X 15" MIRAGE
VIN 4D623380 ON

RRP ex vat £157.15
SALE PRICE
ex vat inc vat
£51.06 £60.00
Part No. RRC005330MNH



5 DOOR

RRP ex vat £48.04
SALE PRICE
ex vat inc vat
£21.28 £25.00
Part No. VTW100000

ROVER 45

CD AUTO-CHANGER 6 DISC



RECONDITIONED

RRP ex vat £117.48
SALE PRICE
ex vat inc vat
£29.79 £35.00
Part No. XQE10025DR

ROVER 45

HANDBOOKS



RRP ex vat £27.81
SALE PRICE
ex vat inc vat
£10.00 £10.00

Part Nos.
ITALIAN VDC000600IT
PORTUGUESE VDC000600PT
GERMAN VDC000600DE

ITALIAN & PORTUGUESE
VIN 637209 ON - 2004 ON
GERMAN
VIN 612918 TO 637208

ORDER BY PHONE: 01522 568000 / ON LINE: www.rimmerbros.co.uk / E-MAIL: mgrover@rimmerbros.co.uk

MG ZS & ROVER 45/400

MG ROVER CLEARANCE BARGAINS

SAVE UP TO
93%
ON MG ROVER
PRICES!

Pick up a bargain today on these heavily discounted genuine MG Rover parts. First come first served. Limited quantities of product available. Parts will no longer be available when sold. Shipped anywhere worldwide.

Please check our website for latest availability & additional products.

MG ZT & ROVER 75 SHORT ENGINE

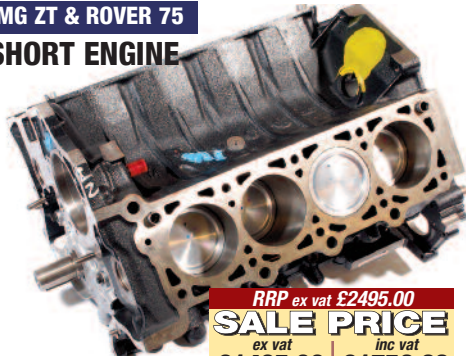

ROVER 75 V8, MG ZT 260
4.6 V8

RRP ex vat £2495.00
SALE PRICE
ex vat inc vat
£1495.00 £1756.63
Part No. LBB002540

MG ZT & ROVER 75

CYLINDER BLOCK ASSEMBLY



BMW
2L DIESEL

RRP ex vat £1194.00
SALE PRICE
ex vat inc vat
£500.00 £587.50
Part No. LCF105160

MG ZT & ROVER 75

CRANKSHAFT PULLEY



ROVER 75 V8 & MG ZT 260
RRP ex vat £84.02
SALE PRICE
ex vat inc vat
£42.55 £50.00
Part No. LHH000070

MG ZT & ROVER 75

PULLEY



ROVER 75 V8 & MG ZT 260
RRP ex vat £22.38
SALE PRICE
ex vat inc vat
£8.51 £10.00
Part No. PQR000290

MGZT & ROVER 75

BARE CYLINDER HEAD



1.8 K SERIES

RRP ex vat £
SALE PRICE
ex vat inc vat
£263.83 £310.00
Part No. LDF109390L

ROVER 75

HAND BRAKE LEVER & GRIP ASSEMBLY



AVAILABLE WITH DEEP
SEA GREEN OR NEPTUNE
BLUE LEATHER GRIP

RRP ex vat £73.87
SALE PRICE
ex vat inc vat
£21.28 £25.00
Part Nos.
DEEP SEA GREEN LEATHER
SNB100346HEE
NEPTUNE BLUE LEATHER
SNB100346JEX

MG ZT & ROVER 75

FRONT SUSPENSION KNUCKLE



ROVER 75 V8 & MG ZT 260
RRP ex vat from £752.61
SALE PRICE
ex vat inc vat
£150.00 £176.25
Part Nos.
RH RBK000261
LH RBK000271

MG ZT & ROVER 75

TIMING COVER



ROVER 75 V8
& MG ZT 260

RRP ex vat £293.46
SALE PRICE
ex vat inc vat
£127.66 £150.00
Part No. LJR000390

MG ZT & ROVER 75

MECHANISM ASSEMBLY



ROVER 75 V8
& MG ZT 260

RRP ex vat £207.87
SALE PRICE
ex vat inc vat
£85.11 £100.00
Part No. UKD000260
GEAR
CHANGE
MANUAL

MG ZT & ROVER 75

REAR LINK ASSY



ROVER 75 V8 & MG ZT 260
RRP ex vat £239.88
SALE PRICE
ex vat inc vat
£80.85 £95.00
Part No. RGD000480

ROVER 75

GASKET - MOUNTING PLATE



DIESEL

RRP ex vat £1.49
SALE PRICE
ex vat inc vat
£0.85 £1.00
Part No. LVJ000040

MG ZT & ROVER 75

CLUTCH HOUSINGS



DIESEL INC. BEARINGS

RRP ex vat £321.72
SALE PRICE
ex vat inc vat
£127.66 £150.00
Part No. TRD000080

ROVER 75

HAND BRAKE CABLE ASSEMBLY



TO VIN 3D280037
MAY REQUIRE
1 X SPU100190
BRACKET

RRP ex vat £45.73
SALE PRICE
ex vat inc vat
£17.02 £20.00
Part No. SPB101550

ROVER 75

1800 PETROL

RRP ex vat £338.67
SALE PRICE
ex vat inc vat
£106.38 £125.00
Part No. TRD000090

MG ZT & ROVER 75

FRONT BRAKE HOSE



EXC 190PS
VIN XM111304 ON

RRP ex vat £28.44
SALE PRICE
ex vat inc vat
£17.02 £20.00
Part No. SHB000840

ROVER 75

THROTTLE BODY ASSEMBLY



PLASTIC BODY

RRP ex vat £281.42
SALE PRICE
ex vat inc vat
£63.83 £75.00
Part No. MHB102141

MG ZT & ROVER 75

FLYWHEEL



RRP ex vat £84.44
SALE PRICE
ex vat inc vat
£42.55 £50.00
Part No. PSD000580

MG ZT & ROVER 75

RH DRIVE SHAFT & INNER JOINT



1800 AUTOMATIC

RRP ex vat £250.58
SALE PRICE
ex vat inc vat
£80.85 £95.00
Part No. TDR100870

MG ZT & ROVER 75

DRIVESHAFT GAITER



RRP ex vat £15.53
SALE PRICE
ex vat inc vat
£8.51 £10.00
Part No. TDD000010

ROVER 75 V8
& MG ZT 260

MG ROVER CLEARANCE BARGAINS

SAVE UPTO
93%
ON MG ROVER
PRICES!

Pick up a bargain today on these heavily discounted genuine MG Rover parts.
First come first served. Limited quantities of product available.
Parts will no longer be available when sold. Shipped anywhere worldwide.

Please check our website for latest availability & additional products.

MG ZT & ROVER 75

CAMSHAFTS

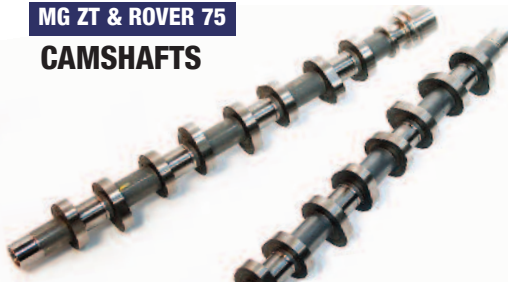

RRP ex vat £180.00
SALE PRICE
ex vat inc vat
£21.28 £25.00

RH/LH
4.6 V8 & ZT 260

Part Nos.
RH - LGC000560
LH - LGC000570

MG ZT & ROVER 75

ALLOY ROAD WHEEL



RRP ex vat £266.54
SALE PRICE
ex vat inc vat
£148.94 £175.00

Part No. RRC005341MNV

ROVER 75 V8, MG ZT260

MG ZT & ROVER 75

STEEL SPACE SAVER ROAD WHEEL



16" X 4J

RRP ex vat £75.72
SALE PRICE
ex vat inc vat
£21.27 £24.99

Part No. RRC113750PMN

MG ZT & ROVER 75

DIFF MOUNTING BUSH



RRP ex vat £33.75
SALE PRICE
ex vat inc vat
£21.27 £24.99

MG ZT260 &
ROVER 75 V8

Part No. TBS000040

MG ZT & ROVER 75

MANIFOLD STUD



RRP ex vat £1.60
SALE PRICE
ex vat inc vat
£0.85 £1.00

ROVER 75 V8
& MG ZT

Part No. LYR000091

ROVER 75 ROAD WHEEL FITTING KITS

SET OF 4



15" WHEEL
SILVER SPARKLE

RRP ex vat £79.37
SALE PRICE
ex vat inc vat
£25.53 £30.00

Part No. RRB100450



16" & 17" WHEEL ALLOYS
SILVER SPARKLE

RRP ex vat £70.05
SALE PRICE
ex vat inc vat
£25.53 £30.00

Part No. RRB100460



17" WHEEL 5 SPOKE
SILVER SPARKLE

RRP ex vat £89.68
SALE PRICE
ex vat inc vat
£25.53 £30.00

Part No. RRB100470



17" WHEEL 7 SPOKE
SILVER SPARKLE

RRP ex vat £85.20
SALE PRICE
ex vat inc vat
£25.53 £30.00

Part No. RRB100480

ROVER 75

CAP ASSEMBLY ALLOY WHEEL



6.5J X 16" WHEEL
SILVER SPARKLE

RRP ex vat £24.63
SALE PRICE
ex vat inc vat
£6.81 £8.00

Part No. RRJ100100MNH

MG ZT-ZTT

WHEEL CENTRE TRIM

FOR 5 SPOKE & 11 SPOKE WHEEL
SILVER SPARKLE



RRP ex vat £14.68
SALE PRICE
ex vat inc vat
£8.51 £10.00

Part No. DTC000090MNH

ROVER 75 V8 HANDBOOK



RRP ex vat £27.81
SALE PRICE
ex vat inc vat
£10.00 £10.00

FRENCH OR ITALIAN

Part Nos.
FRENCH VDC000630FR
ITALIAN VDC000630IT

ROVER 75

FLANGED HEAD BOLT



DIESEL

RRP ex vat £1.15
SALE PRICE
ex vat inc vat
£0.64 £.75

Part No. LYP101640

MG ZT & ROVER 75

REAR BRAKE DISC BOLT



ROVER 75 V8
& MG ZT 260

RRP ex vat £1.71
SALE PRICE
ex vat inc vat
£0.85 £1.00

Part No. SYG000050

MG ZT & ROVER 75

REAR SEAT PROTECTOR



RRP ex vat £55.48
SALE PRICE
ex vat inc vat
£21.28 £25.00

SALOON - GREY

Part No. VUK105080

MG ZT & ROVER 75

SNOW CHAINS



RRP ex vat £72.92
SALE PRICE
ex vat inc vat
£34.04 £40.00

FITS 195/70/14
195/65/15, 205/55/15
215/50/15, 205/50/16

Part No. VUJ10001

ORDER BY PHONE: 01522 568000 / ON LINE: www.rimmerbros.co.uk / E-MAIL: mgrover@rimmerbros.co.uk

MG ROVER CLEARANCE BARGAINS

SAVE UP TO
93%
ON MG ROVER
PRICES!

Pick up a bargain today on these heavily discounted genuine MG Rover parts.
First come first served. Limited quantities of product available.
Parts will no longer be available when sold. Shipped anywhere worldwide.

Please check our website for latest availability & additional products.

ROVER 75 INSTRUMENT PACKS



RRP ex vat £286.51
SALE PRICE
ex vat inc vat
£34.04 £40.00
Part No. YAC003780LNF

KMH FROM VIN 3D284126
AMBER NOT TRIP



RRP ex vat £463.79
SALE PRICE
ex vat inc vat
£34.04 £40.00
Part No. YAC003800LNF

KMH - DIESEL FROM VIN 3D284126
AMBER WITH TRIP

MG ZT INSTRUMENT PACKS



RRP ex vat £653.49
SALE PRICE
ex vat inc vat
£63.83 £75.00
Part No. YAC003970LNL

KPH MG ZT 260 TO VIN 4D000218
LOWLINE



RRP ex vat £272.99
SALE PRICE
ex vat inc vat
£34.04 £40.00
Part No. YAC005070LNF

KPH - MG ZTT FROM VIN 4D321638
BLUE ILLUMINATION
LOWLINE

MG ZT & ROVER 75



RRP ex vat £144.54
SALE PRICE
ex vat inc vat
£42.55 £50.00
Part No. JFC102142PUY

RHD ROVER 75 V8, MG ZT260
LESS AIR-CON

MG ZT & ROVER 75



RRP ex vat £15.64
SALE PRICE
ex vat inc vat
£8.51 £10.00
Part No. XDE100840LPR

FRONT EXCEPT SUN ROOF
SMOKESTONE

ROVER 75 GEAR LEVER GAITER & FINISHER



AUTOMATIC AUBERGINE
RRP ex vat £25.57
SALE PRICE
ex vat inc vat
£12.77 £15.00
Part No. FJL102140KMW



MANUAL AUBERGINE
RRP ex vat £26.47
SALE PRICE
ex vat inc vat
£12.77 £15.00
Part No. FJL102150KMW

MG ZT & ROVER 75 GEAR LEVER KNOBS

AUBERGINE LEATHER
RRP ex vat £37.93
SALE PRICE
ex vat inc vat
£17.02 £20.00
Part No. UKJ100421KMW



ROVER 75 V8, MG ZT260
BLACK LEATHER
RRP ex vat £67.17
SALE PRICE
ex vat inc vat
£17.02 £20.00
Part No. UKJ000110PMA

MG ZT & ROVER 75

AUTO GEARLEVER HANDLE

RRP ex vat £38.00
SALE PRICE
ex vat inc vat
£10.64 £12.50
Part No. UCK100260LNF

ASH GREY LEATHER - CHROME

ROVER 75

GEAR LEVER GAITER RETAINER

RRP ex vat £5.20
SALE PRICE
ex vat inc vat
£2.55 £3.00
Part No. FJN100320PMA

MANUAL

ROVER 75

PARCEL SHELF



SANDSTONE BEIGE
RRP ex vat £90.07
SALE PRICE
ex vat inc vat
£34.04 £40.00
Part No. EPB101250SCD

MG ZT & ROVER 75

SUN VISORS



LHD DRIVERS SIDE ILLUMINATED WITH MIRROR SMOKESTONE
RRP ex vat £45.72
SALE PRICE
ex vat inc vat
£17.02 £20.00
Part No. EDQ103850LPR



RHD JAPAN DRIVERS SIDE ILLUMINATED WITH MIRROR - BEIGE
RRP ex vat £47.00
SALE PRICE
ex vat inc vat
£17.02 £20.00
Part No. EDQ104890SCD



LHD PASSENGER SIDE ILLUMINATED WITH MIRROR - BEIGE
RRP ex vat £52.75
SALE PRICE
ex vat inc vat
£17.02 £20.00
Part No. EDQ105380SCD

MG ZT & ROVER 75

FACIA MATS

RRP ex vat £5.23
SALE PRICE
ex vat inc vat
£3.40 £4.00
Part No. FAH100330LNF



PASSENGER SIDE
RRP ex vat £3.94
SALE PRICE
ex vat inc vat
£2.55 £3.00
Part No. FAH100340LNF



DRIVERS SIDE
RRP ex vat £46.56
SALE PRICE
ex vat inc vat
£8.51 £10.00
Part No. EAH105150SCD

ROVER 75

FABRIC MAT SET
RRP ex vat £21.26
SALE PRICE
ex vat inc vat
£8.51 £10.00
Part No. EAH104400SCD



LHD SANDSTONE BEIGE
RRP ex vat £45.92
SALE PRICE
ex vat inc vat
£8.51 £10.00
Part No. XPT000130ACB

MG ZT

FABRIC MAT SET - LHD
MG ZT260

MG ROVER CLEARANCE BARGAINS

SAVE UP TO
93%
ON MG ROVER
PRICES!

Pick up a bargain today on these heavily discounted genuine MG Rover parts.
First come first served. Limited quantities of product available.
Parts will no longer be available when sold. Shipped anywhere worldwide.

Please check our website for latest availability & additional products.

MG ZT & ROVER 75

MG ZT & ROVER 75

BODY SIDES

RRP ex vat £458.45
SALE PRICE
ex vat inc vat
£148.94 £175.00
Part No. ALA500360

RH
TOURER
ROVER 75 & MG ZTT



RRP ex vat £416.40
SALE PRICE
ex vat inc vat
£106.38 £125.00
Part No. ALA500140

RH
SALOON
ROVER 75
& MG ZT



ROVER 75

FRONT SUBFRAME ASSEMBLY

RRP ex vat £824.58
SALE PRICE
ex vat inc vat
£250.00 £293.75
Part No. KGB000311

PETROL



MG ZT & ROVER 75

REAR WINDOW REGULATORS

RRP ex vat £31.13
SALE PRICE
ex vat inc vat
£21.28 £25.00
Part Nos.
RH CVH101180
LH CVH101190



MG ZT & ROVER 75

GLASS ASSEMBLY FRONT DOOR

RRP ex vat £128.75
SALE PRICE
ex vat inc vat
£34.04 £40.00
Part No. CUB102440

RH
GREEN



MG ZT BOOT LID ASSEMBLY

RRP ex vat £431.79
SALE PRICE
ex vat inc vat
£250.00 £293.75
Part No. BMD500140



ROVER 75

FRONT SIDE LAMP

RRP ex vat £35.39
SALE PRICE
ex vat inc vat
£12.77 £15.00
Part No. XGB000100

FROM VIN
4D321638



MG ZTT & ROVER 75

WELL ASSEMBLY SPARE WHEEL

TOURER
RRP ex vat £146.35
SALE PRICE
ex vat inc vat
£43.48 £51.09
Part No. AFN500030



ROVER 75

FRONT FOG LAMP KIT

RRP ex vat £49.19
SALE PRICE
ex vat inc vat
£12.55 £14.75
Part No. XBQ000100

PETROL & DIESEL
EXCEPT AUTO
FROM VIN 217661 TO
04 MODEL YEAR



ROVER 75

REAR SUBFRAME MOUNTING

RRP ex vat £12.80
SALE PRICE
ex vat inc vat
£6.81 £8.00
Part No. KHC100840

SALOON
& TOURER



ROVER 75

TOOL STORAGE RH BOX

RRP ex vat £44.67
SALE PRICE
ex vat inc vat
£12.77 £15.00
Part No. EOX100001

TOURER
TO VIN 3D277640



ROVER 75

BOOT RACK SALOON

RRP ex vat £70.81
SALE PRICE
ex vat inc vat
£34.04 £40.00
Part No. VTF100040



MG ZTT

TAILGATE TRIM (NUMBER PLATE)

RRP ex vat from £33.22
SALE PRICE
ex vat inc vat
£21.28 £25.00
Part No.
SOLAR RED DED000060CMU
LE MANS GREEN DED000060HFN
ROYAL BLUE DED000060JFM

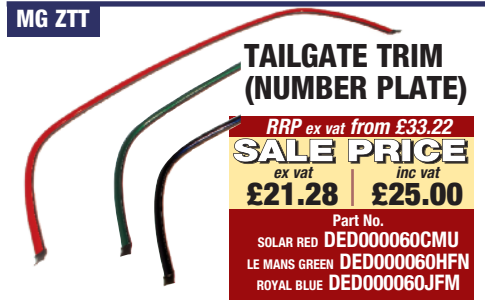

ROVER 75

BEAM DEFLECTOR KIT - LHD

RRP ex vat £17.94
SALE PRICE
ex vat inc vat
£8.51 £10.00
Part No. XBQ100920

TO VIN 4D321638



MG ZT & ROVER 75

SPORTS SILL FINISHERS

RRP ex vat £76.55
SALE PRICE
ex vat inc vat
£25.53 £30.00
Part Nos.
RH - DDJ000400LML
LH - DDJ000410LML

SALOON & TOURER



MG ZT

REAR BADGE PLINTH

RRP ex vat £17.84
SALE PRICE
ex vat inc vat
£9.95 £11.69
Part No. DAS00060LML



ROVER 75

DOOR EDGE REFLECTOR

RRP ex vat £3.22
SALE PRICE
ex vat inc vat
£0.85 £1.00
Part No. XDJ000040



MG ZT & ROVER 75

SKI RACK

RRP ex vat £95.04
SALE PRICE
ex vat inc vat
£42.55 £50.00
Part No. CAN100140



MG ZT & ROVER 75

SKI BAG

RRP ex vat £84.38
SALE PRICE
ex vat inc vat
£21.28 £25.00
Part No. VUP100090

CAN ONLY BE
USED ON
CARS WITH
REAR SEAT
LOAD
THROUGH



ORDER BY PHONE: 01522 568000 / ON LINE: www.rimmerbros.co.uk / E-MAIL: mgrover@rimmerbros.co.uk 26

MG ROVER CLEARANCE BARGAINS

SAVE UP TO
93%
ON MG ROVER
PRICES!

Pick up a bargain today on these heavily discounted genuine MG Rover parts.
First come first served. Limited quantities of product available.
Parts will no longer be available when sold. Shipped anywhere worldwide.

Please check our website for latest availability & additional products.

CITY ROVER OVERMAT SET



RRP ex vat £21.23
SALE PRICE
ex vat inc vat
£8.51 £10.00
Part No. XPT000068ACB

LHD GRAPHITE

CITY ROVER



FRONT
RRP ex vat £22.12
SALE PRICE
ex vat inc vat
£8.51 £10.00
Part No. XPT000069ACA

RUBBER FLOOR MAT SETS

REAR
RRP ex vat £25.13
SALE PRICE
ex vat inc vat
£8.51 £10.00
Part No. XPT000069ACB

CITY ROVER RUBBER LOAD SPACE



RRP ex vat £19.87
SALE PRICE
ex vat inc vat
£8.51 £10.00
Part No. XPT000066ACA

CITY ROVER

MUDFLAP KITS



RRP ex vat £16.99
SALE PRICE
ex vat inc vat
£8.51 £10.00
Part Nos.
FRONT XPT000075ACA
REAR XPT000065ACA

FRONT OR REAR PAIRS

CITY ROVER



RRP ex vat £22.35
SALE PRICE
ex vat inc vat
£8.51 £10.00
Part No. XPT000106ACA

HEADLAMP PROTECTOR

CITY ROVER

CYLINDER HEAD ASSEMBLY



1400CC 8V INCLUDES VALVES

RRP ex vat £303.85
SALE PRICE
ex vat inc vat
£165.96 £195.00
Part No. 279101150119

CITY ROVER

POWER STEERING RACK - RHD



RRP ex vat £460.22
SALE PRICE
ex vat inc vat
£148.94 £175.00
Part No. 277946600106

CITY ROVER

AIR CONDITIONING UNIT



SELECT/STYLE VIN PR17664 ON
RRP ex vat £131.21
SALE PRICE
ex vat inc vat
£95.00 £111.63
Part No. 284483400116

CITY ROVER

BRAKE SERVO



ABS
RRP ex vat £295.02
SALE PRICE
ex vat inc vat
£250.00 £293.75
Part No. 284243100106

CITY ROVER

REAR ARM - RH NO ABS



RRP ex vat £48.79
SALE PRICE
ex vat inc vat
£25.53 £30.00
Part No. 282032420113

CITY ROVER

INLET MANIFOLD



RRP ex vat £168.75
SALE PRICE
ex vat inc vat
£63.83 £75.00
Part No. 279114100108

CITY ROVER

FRONT PIPE ASSEMBLY



RRP ex vat £130.78
SALE PRICE
ex vat inc vat
£42.55 £50.00
Part No. 284249200101

MINI & ALLEGRO



SUMP GASKET

RRP ex vat £11.20
SALE PRICE
ex vat inc vat
£4.25 £4.99
Part No. LVF703007EVA

1.0/1.1/1.3 LITRE

MINI



HEATER HOSE

RRP ex vat £8.71
SALE PRICE
ex vat inc vat
£3.40 £4.00
Part No. PCH001007EVA

ROVER MINI

SUSPENSION CONE



RRP ex vat £71.06
SALE PRICE
ex vat inc vat
£35.32 £41.50
Part No. FAM3968

MINI



SEAT CROSSMEMBER

RRP ex vat £222.41
SALE PRICE
ex vat inc vat
£72.34 £85.00
Part No. CZH2675

1974 ON ROD CHANGE

MORRIS MARINA



INDICATOR SWITCH - RHD 1975 ON

RRP ex vat £58.23
SALE PRICE
ex vat inc vat
£25.53 £30.00
Part No. AAU1857

TATA

RIGID LOAD LINER



RRP ex vat £132.35
SALE PRICE
ex vat inc vat
£50.00 £58.75
Part No. XPT000041ACA

LOADBETA

MG ROVER CLEARANCE BARGAINS

SAVE UP TO
93%
ON MG ROVER
PRICES!

Pick up a bargain today on these heavily discounted genuine MG Rover parts.
First come first served. Limited quantities of product available.
Parts will no longer be available when sold. Shipped anywhere worldwide.

Please check our website for latest availability & additional products.

METRO & ROVER 100

METRO/ROVER 100



DOORS
5 DOOR
1990 ON

RRP ex vat from £300.85
SALE PRICE
ex vat inc vat
£63.83 | £75.00

Part Nos.
RH FRONT (5 door) - BDA390540
LH FRONT (5 door) - BDA390550
LH REAR (5 door) - BFA390150



5 DOOR 1990 ON
RRP ex vat from £315.45
SALE PRICE
ex vat inc vat
£85.11 | £100.00

Part No.
RH REAR (5 door) - BFA390140



3 DOOR
FROM BD

RRP ex vat £278.75
SALE PRICE
ex vat inc vat
£80.85 | £95.00

Part No.
RH FRONT (3 door) - BDA390520

METRO/ROVER 100

DOOR SKINS

REDUCED



RRP ex vat £97.06
SALE PRICE
ex vat inc vat
£21.28 | £25.00

Part Nos.
LH FRONT (3 door) - BDA39015
LH FRONT (5 door) - BDA39017
RH REAR (5 door) - BFA39010
LH REAR (5 door) - BFA39011



1990 ON
RRP ex vat £100.75
SALE PRICE
ex vat inc vat
£29.79 | £35.00

Part No.
RH FRONT (3 door) - BDA39014



RRP ex vat £97.82
SALE PRICE
ex vat inc vat
£34.04 | £40.00

Part No.
RH FRONT (5 door) - BFA39016

METRO/ROVER 100

FRONT WING



RH
1980 TO 1991

RRP ex vat £63.69
SALE PRICE
ex vat inc vat
£25.53 | £30.00
Part No. AFP572

METRO/ROVER 100



TAILGATE ASSEMBLIES

1990 ON

RRP ex vat £291.18
SALE PRICE
ex vat inc vat
£63.83 | £75.00
Part Nos.
NON SPOILER TYPE - BHA39001
SPOILER TYPE - BHA39007

METRO/ROVER 100



TAILGATE SPOILER

RRP ex vat £238.43
SALE PRICE
ex vat inc vat
£42.55 | £50.00
Part No. DFD10083PML

BLACK

METRO/ROVER 100



SILL PANELS
3 DOOR

RH OR LH

RRP ex vat £105.71
SALE PRICE
ex vat inc vat
£29.79 | £35.00
Part Nos.
RH - ALA390440
LH - ALA390450

METRO/ROVER 100

DOOR HANDLE



BLACK PLASTIC

LH
FRONT/REAR

RRP ex vat £44.67
SALE PRICE
ex vat inc vat
£12.77 | £15.00
Part No. CXB10073PMD

ROVER 100



PRIMED

RRP ex vat £91.71
SALE PRICE
ex vat inc vat
£21.27 | £24.99
Part No. CXB101620LML

METRO



DOOR GLASS

LH FRONT

3 DOOR
BRONZE TINT

RRP ex vat £73.17
SALE PRICE
ex vat inc vat
£21.28 | £25.00
Part No. AFP1007

ROVER METRO

BUMPERS



FRONT 1400 GTI 16V
REAR 1400 GTA

RRP ex vat £150.00
SALE PRICE
ex vat inc vat
£42.55 | £50.00

Part Nos.
FRONT - DPC101180LML
REAR - DQB102040PAQ

METRO L & GS



BUMPER COVERS

RRP ex vat £96.13
SALE PRICE
ex vat inc vat
£29.79 | £35.00

Part Nos.
FRONT - DPC10050LML
REAR - DQC10036LML

OCT 1984 TO SEPT 1991

METRO CITY / X / VAN ETC



BUMPER CENTRES

REDUCED

RRP ex vat £39.57
SALE PRICE
ex vat inc vat
£17.02 | £20.00

Part Nos.
FRONT - JRC5127
REAR - JRC5128

METRO



LOWER FRONT PANEL

1984 TO 1991

RRP ex vat £14.70
SALE PRICE
ex vat inc vat
£8.51 | £10.00
Part No. AFP906

METRO/ROVER 100

GRILLE



AMARANTH

RRP ex vat £77.25
SALE PRICE
ex vat inc vat
£25.53 | £30.00
Part No. DHB102010KMN

METRO & ROVER 100

SUNROOF (GLASS) ASSEMBLY



RRP ex vat £733.78
SALE PRICE
ex vat inc vat
£106.38 | £125.00
Part No. EED100930LNG

CHASSIS NO.
AD552383 ON

MG ROVER CLEARANCE BARGAINS

SAVE UP TO
93%
ON MG ROVER
PRICES!

Pick up a bargain today on these heavily discounted genuine MG Rover parts. First come first served. Limited quantities of product available. Parts will no longer be available when sold. Shipped anywhere worldwide.

Please check our website for latest availability & additional products.

ROVER METRO

HOOD SEAL



CABRIOLET
BLACK

RRP ex vat £70.17
SALE PRICE
ex vat inc vat
£25.53 £30.00
Part No. DSF100870PMA

METRO/ROVER 100



**FRONT
SUBFRAME
ASSEMBLY**

RRP ex vat £475.72
SALE PRICE
ex vat inc vat
£127.66 £150.00
Part No. KGB100950

METRO

TRACK ROD END



1980 TO 1992
RRP ex vat £5.15
SALE PRICE
ex vat inc vat
£3.40 £4.00
Part No. RBK000614EVA

METRO & ROVER 100

TAILGATE SEALS



RRP ex vat £34.42
SALE PRICE
ex vat inc vat
£12.77 £15.00
Part No. AFP1013

TO OCT 1984

METRO & ROVER 100

**UPPER
SUSPENSION
ARMS**



RRP ex vat £331.19
SALE PRICE
ex vat inc vat
£42.55 £50.00 PAIR (RH & LH)
Part No. RBJ10004-5 1990 ON

RH/LH
1990 ON

RRP ex vat £161.95
SALE PRICE
ex vat inc vat
£25.53 £30.00
Part Nos.
RH - RBJ10004 LH - RBJ10005

MG METRO

**FRONT SHOCK
ABSORBER**

TURBO
OCT 1984
TO SEPT 1991



RRP ex vat £20.95
SALE PRICE
ex vat inc vat
£12.77 £15.00
Part No. ADU3076EVA



TO VIN AD507467
RRP ex vat £19.84
SALE PRICE
ex vat inc vat
£8.51 £10.00
Part No. CKE10047



VIN AD507468 ON
RRP ex vat £24.95
SALE PRICE
ex vat inc vat
£12.77 £15.00
Part No. CKE10050

METRO & ROVER 100

**SUNROOF
SEAL**



RRP ex vat £27.98
SALE PRICE
ex vat inc vat
£8.51 £10.00
Part No. EEQ10007

METRO & ROVER 100

**ACCELERATOR
CABLE**



LHD
1400 16V MPI
VIN AD885062 ON
RRP ex vat £14.04
SALE PRICE
ex vat inc vat
£8.51 £10.00
Part No. SBB102610

ROVER 100



**CHELSEA
BADGE**

RRP ex vat £41.27
SALE PRICE
ex vat inc vat
£8.47 £9.95
Part No. DAM100610MMM

METRO & ROVER 100



WHEEL TRIMS

FULL WHEEL TRIM
BRIGHT SILVER
RRP ex vat £20.40
SALE PRICE
ex vat inc vat
£8.51 £10.00
Part No. DTB10043MNE

1.4 GSI
VIN AD507468 TO
AD999999
SILVER SPARKLE
RRP ex vat £20.63
SALE PRICE
ex vat inc vat
£8.51 £10.00
Part No. DTB101190MNH

METRO

STEEL ROAD WHEEL



RRP ex vat £53.98
SALE PRICE
ex vat inc vat
£25.53 £30.00
Part No. NAM9361MMH
4.5" X 13"
EXC GTA/SI
TO VIN AD507467

METRO & ROVER 100

**DOOR
WINDOW
REGULATOR**



RRP ex vat £165.56
SALE PRICE
ex vat inc vat
£21.27 £24.99
Part No. CUH10070
RH FRONT
ELECTRIC
5 DOOR MODELS

METRO & ROVER 100

**REAR 1/4 LIGHT GLASS
LIFT MODULE**



RRP ex vat £539.86
SALE PRICE
ex vat inc vat
£80.85 £95.00
Part No. CUV100300PMA
RH - CABRIOLET

METRO

**FLANGE ASSEMBLY
FRONT HUB**



RRP ex vat £69.21
SALE PRICE
ex vat inc vat
£21.28 £25.00
Part No. NAM6028 TO 1991

METRO

**ELECTRIC
TAILGATE RELEASE**



RRP ex vat £50.83
SALE PRICE
ex vat inc vat
£17.02 £20.00
Part No. GAE256

METRO

WHEEL BOLT



RRP ex vat £2.12
SALE PRICE
ex vat inc vat
£0.85 £1.00
Part No. NAM5559
MG TURBO/ADVANTAGE
TO 1991

METRO

REAR WHEEL STUD



RRP ex vat £1.55
SALE PRICE
ex vat inc vat
£0.64 £0.75
1990 ON
Part No. NAM8116

MG ROVER CLEARANCE BARGAINS

SAVE UP TO
93%
ON MG ROVER
PRICES!

Pick up a bargain today on these heavily discounted genuine MG Rover parts.
First come first served. Limited quantities of product available.
Parts will no longer be available when sold. Shipped anywhere worldwide.

Please check our website for latest availability & additional products.

METRO & ROVER 100

METRO

REAR EXHAUSTS



RRP ex vat £65.20
SALE PRICE
ex vat inc vat
£25.53 £30.00
Part No. WCG10118EVA

1.4 LITRE 16V
JAPAN



RRP ex vat £51.48
SALE PRICE
ex vat inc vat
£21.28 £25.00
Part No. WCG10097EVA

1.4 DIESEL
TO VIN AD901315



RRP ex vat £29.30
SALE PRICE
ex vat inc vat
£12.55 £14.75
Part No. WCG033259EVA

VAN
1985 ON



RRP ex vat £17.34
SALE PRICE
ex vat inc vat
£8.51 £10.00
Part No. WCG003913EVA

1.0/1.3 LITRE
1980 TO 1984

METRO

FRONT PIPE ASSEMBLIES



RRP ex vat £59.62
SALE PRICE
ex vat inc vat
£25.53 £30.00
Part No. WCD10122EVA

1.4 LITRE 16V
1990 ON



RRP ex vat £30.83
SALE PRICE
ex vat inc vat
£12.77 £15.00
Part No. WCD10057EVA

1.4 LITRE 8/16V
1990 ON

METRO & ROVER 100

EXHAUST - INTERMEDIATE 1.4 LITRE 16V



RRP ex vat £27.76
SALE PRICE
ex vat inc vat
£14.89 £17.50
Part No. CRC9531EVA

METRO

FUEL TANK ASSEMBLIES



RRP ex vat £279.91
SALE PRICE
ex vat inc vat
£63.83 £75.00
Part No. WFE104330

1100/1400 SINGLE CARB
FROM VIN AD500001 TO AD507466
FROM VIN AD601000 TO AD785649



RRP ex vat £252.04
SALE PRICE
ex vat inc vat
£42.55 £50.00
Part No. WFE104760

SINGLE CARB MODELS

METRO

THROTTLE BODY



1400 8V
RRP ex vat £525.29
SALE PRICE
ex vat inc vat
£63.83 £75.00
Part No. MLB10031

METRO

SUMP GASKET



1.0/1.1/1.3 LITRE
RRP ex vat £11.20
SALE PRICE
ex vat inc vat
£4.25 £4.99
Part No. LVF703007EVS

METRO & ROVER 100

MUDFLAP KITS (PAIRS)



RRP ex vat £7.56
SALE PRICE
ex vat inc vat
£4.25 £4.99
Part Nos.
REAR GREY - CAT100660LOG
REAR BLACK - CAT100660PMD
FRONT GREY - CAS100570LOG

1990 ON

ROVER METRO

MUDFLAP KIT



RRP ex vat £17.83
SALE PRICE
ex vat inc vat
£6.81 £8.00
Part No. CAP10005

SET OF 4
NOT GTA/GTI

METRO

WASH WIPE SWITCH



RRP ex vat £33.64
SALE PRICE
ex vat inc vat
£21.28 £25.00
Part No. AFU2993

3 POSITION
OCT 84 TO VIN A900000

METRO & ROVER 100

STEERING COLUMN SWITCH ASSEMBLY



RRP ex vat £104.75
SALE PRICE
ex vat inc vat
£34.00 £39.95
Part No. XPB10006

TO VIN BD110565

METRO

HEADLAMP ASSEMBLY



1984-1991
RRP ex vat £108.37
SALE PRICE
ex vat inc vat
£34.04 £40.00
Part No. AFU2887

METRO & ROVER 100

HEADLAMP ASSEMBLY



RRP ex vat £97.15
SALE PRICE
ex vat inc vat
£21.27 £24.99
Part No. XBC10171

LH/RHD
TO VIN AD999999

METRO & ROVER 100

HEADLAMP PROTECTORS (PAIR)



RRP ex vat £22.57
SALE PRICE
ex vat inc vat
£8.51 £10.00
Part No. XBV100510

METRO & ROVER 100

FLOOR MATS SET OF 4



LHD
COULD BE ADAPTED TO FIT RHD.
BLACK OR GREY

RRP ex vat £19.80
SALE PRICE
ex vat inc vat
£8.51 £10.00
Part Nos.
BLACK - EAH102010PMA
GREY - EAH102010LOY

MG ROVER CLEARANCE BARGAINS

SAVE UP TO
93%
ON MG ROVER
PRICES!

Pick up a bargain today on these heavily discounted genuine MG Rover parts.
First come first served. Limited quantities of product available.
Parts will no longer be available when sold. Shipped anywhere worldwide.

Please check our website for latest availability & additional products.

ROVER 200/400 DOOR ASSEMBLIES



RRP ex vat £109.46
SALE PRICE
ex vat **£63.83** inc vat **£75.00**
Part No. DBP2511
LH FRONT
ROVER 213/216
XW TO DEC 1989



RRP ex vat £278.75
SALE PRICE
ex vat **£85.11** inc vat **£100.00**
Part No. BDA381700
RH FRONT
ROVER 200/400 XW
5 DOOR
1992 TO 1996



RRP ex vat £270.63
SALE PRICE
ex vat **£63.83** inc vat **£75.00**
Part No. BDA381820
RH FRONT
ROVER 200 XW
3 DOOR
REDUCED



RRP ex vat £278.75
SALE PRICE
ex vat **£100.00** inc vat **£117.50**
Part No. BDA381870
LH FRONT
ROVER 200 XW
CABRIOLET
1992 TO 1996



RRP ex vat £270.63
SALE PRICE
ex vat **£106.38** inc vat **£125.00**
Part No. BDA381880
RH FRONT
ROVER 200 XW COUPE



RRP ex vat £278.75
SALE PRICE
ex vat **£85.11** inc vat **£100.00**
Part Nos.
RH - BFA380400
LH - BFA380410
RH/LH REAR
XW
1992 TO 1996

ROVER 200/400 DOOR SKINS



RRP ex vat £73.46
SALE PRICE
ex vat **£34.04** inc vat **£40.00**
Part Nos.
RH - BDA38042
LH - BDA38043
RH/LH
CABRIOLET/COUPE
XW TO VIN AD798419



RRP ex vat £114.03
SALE PRICE
ex vat **£25.53** inc vat **£30.00**
Part No. BDA38037
LH FRONT
4/5 DOOR
OCT 1992 ON



RRP ex vat £223.39
SALE PRICE
ex vat **£63.83** inc vat **£75.00**
Part Nos.
RH - ALJ380740
LH - ALJ380750
REAR WINGS
RH/LH
400 XW TOURER
1992 ON



RRP ex vat £178.76
SALE PRICE
ex vat **£63.83** inc vat **£75.00**
Part No. ALH38004
RH
XW/CABRIOLET
1992 ON



RRP ex vat £216.53
SALE PRICE
ex vat **£80.85** inc vat **£95.00**
Part No. ALH38006
LH
XW/CABRIOLET
1992 ON



RRP ex vat £102.92
SALE PRICE
ex vat **£80.85** inc vat **£95.00**
Part No. ALA381560
RH
COUPE
XW

ROVER 200 REAR LOWER PANEL



RRP ex vat £86.13
SALE PRICE
ex vat **£25.53** inc vat **£30.00**
Part No. ALA38137
LH
CABRIOLET

ROVER 200/400 BOOT LID ASSEMBLIES



RRP ex vat £166.81
SALE PRICE
ex vat **£63.83** inc vat **£75.00**
Part No. BMD38031
4 DOOR SALOON
1992 TO 1996
ROVER 418SLD



RRP ex vat £181.26
SALE PRICE
ex vat **£80.85** inc vat **£95.00**
Part No. BMD38035
ROVER 200 COUPE
1996 ON



RRP ex vat £186.70
SALE PRICE
ex vat **£63.83** inc vat **£75.00**
Part No. BMD38029
4 DOOR SALOON
ROVER 416/420

ROVER 200 BODY SIDES



RRP ex vat £210.01
SALE PRICE
ex vat **£106.38** inc vat **£125.00**
Part No. ALA38126
RH
CABRIOLET
XW



RRP ex vat £102.92
SALE PRICE
ex vat **£80.85** inc vat **£95.00**
Part No. ALA381560
RH
COUPE
XW

ROVER 400



RRP ex vat £100.60
SALE PRICE
ex vat **£29.79** inc vat **£35.00**
Part No. ALA38074
RH
4 DOOR
OCT 1992 TO OCT 1996

MG ROVER CLEARANCE BARGAINS

SAVE UP TO
93%
ON MG ROVER
PRICES!

Pick up a bargain today on these heavily discounted genuine MG Rover parts.
First come first served. Limited quantities of product available.
Parts will no longer be available when sold. Shipped anywhere worldwide.

Please check our website for latest
availability & additional products.

ROVER 200 & 400

ROVER 200/400 BUMPERS



FRONT
ROVER 216/220 GTI
XW TO VIN AD798419
3 DOOR - WITH FOG LAMPS

RRP ex vat £209.29
SALE PRICE
ex vat **£63.83** inc vat **£75.00**
Part No. DPB102470LML



REAR
ROVER 218
5 DOOR DIESEL
XW VIN AD798420 TO
BD127064
GREY - WITH CHROME INSERTS

RRP ex vat £213.21
SALE PRICE
ex vat **£42.55** inc vat **£50.00**
Part No. DQB101910LPM



REAR
ROVER 400
TOURER/DIESEL
OCT 1992 ON

RRP ex vat £217.35
SALE PRICE
ex vat **£63.83** inc vat **£75.00**
Part No. DQB102020

ROVER 200/400 BONNET ASSEMBLY



XW RANGE
OCT 1992 ON

RRP ex vat £172.61
SALE PRICE
ex vat **£63.83** inc vat **£75.00**
Part No. BKA38068

ROVER 200/400 GRILLE - PLENUM



RHD
XW COUPE

RRP ex vat £61.74
SALE PRICE
ex vat **£25.53** inc vat **£30.00**
Part No. ECJ10004



EXCEPT COUPE
OCT 1992 ON

RRP ex vat £68.40
SALE PRICE
ex vat **£21.28** inc vat **£25.00**
Part No. ECJ10002

ROVER 200/400 TAILGATES



ROVER 200
3/5 DOOR
XW 1992 TO 1996

RRP ex vat £224.23
SALE PRICE
ex vat **£80.85** inc vat **£95.00**
Part No. BHA38083



ROVER 200
3/5 DOOR
XW 1992 TO 1996
NO SPOILER

REDUCED
RRP ex vat £216.34
SALE PRICE
ex vat **£63.83** inc vat **£75.00**
Part No. BHA38084



ROVER 400
TOURER

RRP ex vat £501.40
SALE PRICE
ex vat **£80.85** inc vat **£95.00**
Part No. BHA380940

ROVER 200 HOOD LIFT ASSEMBLY



CABRIOLET
MANUAL HOOD

RRP ex vat £58.17
SALE PRICE
ex vat **£25.53** inc vat **£30.00**
Part No. DSR10002

ROVER 200 'D' POST BADGE



3 DOOR & CABRIOLET

RRP ex vat £32.75
SALE PRICE
ex vat **£8.47** inc vat **£9.95**
Part No. DAB10056

ROVER 200/400 GRILLE KIT



EXCEPT COUPE
TO 1993

RRP ex vat £36.32
SALE PRICE
ex vat **£21.28** inc vat **£25.00**
Part No. DHP100040

ROVER 200/400 DOOR ACTUATOR & LATCH ASSEMBLY



LH REAR
1992 TO 1996

RRP ex vat £145.10
SALE PRICE
ex vat **£17.02** inc vat **£20.00**
Part No. FUB10113



FRONT
CDL/XW

RRP ex vat £108.21
SALE PRICE
ex vat **£25.53** inc vat **£30.00**
Part No. FUB10083

ROVER 200/400 WINDOW REGULATORS



RH FRONT
3 DOOR
OCT 92 TO FEB 96

RRP ex vat £76.97
SALE PRICE
ex vat **£21.28** inc vat **£25.00**
Part No. CUH10122



LH FRONT
MANUAL RHD - 3 DOOR

RRP ex vat £66.54
SALE PRICE
ex vat **£21.27** inc vat **£24.99**
Part No. CUH10123

Note: It may be possible to re-hand window regulators depending upon application. (ie: RHL/LH, RHD/LHD etc.)



RH/LH FRONT
ELECTRIC
3 DOOR

RRP ex vat £186.15
SALE PRICE
ex vat **£21.27** inc vat **£24.99**
Part Nos.
RHD FRONT RH - CUH10124
LHD FRONT LH - CUH10125



RH/LH REAR
MANUAL RHD - 5 DOOR

RRP ex vat £92.33
SALE PRICE
ex vat **£21.27** inc vat **£24.99**
Part Nos.
RH - CVH10054
LH - CVH10055



LH REAR
ELECTRIC
RHD - 5 DOOR

RRP ex vat £164.75
SALE PRICE
ex vat **£21.27** inc vat **£24.99**
Part No. CVH10053

ROVER 200/400 XW WINDOW REGULATOR MOTOR



RH
COUPE

RRP ex vat £205.48
SALE PRICE
ex vat **£42.55** inc vat **£50.00**
Part No. CUR100320

ROVER 200 DOOR WINDOW CABLE



RH
COUPE

RRP ex vat £228.11
SALE PRICE
ex vat **£25.53** inc vat **£30.00**
Part No. CVV100040

MG ROVER CLEARANCE BARGAINS

SAVE UP TO
93%
ON MG ROVER
PRICES!

Pick up a bargain today on these heavily discounted genuine MG Rover parts.
First come first served. Limited quantities of product available.
Parts will no longer be available when sold. Shipped anywhere worldwide.

Please check our website for latest availability & additional products.

ROVER 200/400 DOOR MIRRORS

Door mirrors can be re-painted to suit.
Aerosols AVAILABLE - please enquire.



RRP ex vat £120.00
SALE PRICE
ex vat inc vat
£21.27 £24.99
Part Nos.
NIGHTFIRE - CRB106220C0Q
CAR. BLUE - CRB106270UME

RH ELECTRIC
VIN AD642715 TO
AD837858
NIGHTFIRE OR
CARRIBEAN BLUE



RRP ex vat £141.72
SALE PRICE
ex vat inc vat
£21.27 £24.99
Part No. CRB106360C0Q

RH/RHD ELECTRIC
COUPE
XW VIN AD642715 TO
AD837858
NIGHTFIRE RED



RRP ex vat £120.86
SALE PRICE
ex vat inc vat
£21.27 £24.99
Part No. CRB106390HNA

LH/LHD ELECTRIC
COUPE
XW VIN AD642715 TO
AD837858
BRITISH RACING GREEN



RRP ex vat £135.29
SALE PRICE
ex vat inc vat
£21.27 £24.99
Part No. CRB106220MNS

RH ELECTRIC
AD642715 TO AD837858
QUICKSILVER



RRP ex vat £69.81
SALE PRICE
ex vat inc vat
£17.02 £20.00
Part No. DKP5687

LH/RHD MANUAL
ROVER 213/216
VIN B100051 ON



RRP ex vat £136.27
SALE PRICE
ex vat inc vat
£21.28 £25.00
Part Nos.
BLACK RH - CRB10474PMF
OCEAN BLUE LH - CRB106270JRN

RH/LH ELECTRIC
XW 92-96
BLACK & OCEAN BLUE



RRP ex vat £118.26
SALE PRICE
ex vat inc vat
£21.28 £25.00
Part No. CRB106380C0Q

LHD/RH
ELECTRIC
XW 92-96
NIGHTFIRE RED



RRP ex vat £78.08
SALE PRICE
ex vat inc vat
£17.02 £20.00
Part Nos.
FLAME RED - CRB106140COF
B.R. GREEN - CRB106300HNA

RH MANUAL
XW 92-96 VIN AD642715
TO AD837858
FLAME RED

ALSO AVAILABLE IN
BRITISH RACING GREEN



RRP ex vat £132.93
SALE PRICE
ex vat inc vat
£21.27 £24.99
Part No. CRB106270UME

LH/RHD ELECTRIC
NOT COUPE
XW VIN AD642715 TO
AD837858
CARIBEAN BLUE

RRP ex vat £132.93
SALE PRICE
ex vat inc vat
£21.27 £24.99
Part No. CRB106270UME



RH/LH
REMOTE CONTROL
VIN AD837858 ON
BLACK

ROVER 200/400 DOOR MIRROR COVER



RRP ex vat £27.50
SALE PRICE
ex vat inc vat
£12.77 £15.00
Part No. CRC100110JRJ

LH MANUAL
XW 92-96 TAHITI BLUE

ROVER 200/400 RADIO CASSETTE (R770)



RRP ex vat £399.51
SALE PRICE
ex vat inc vat
£25.00 £29.38
Part No. XQD101260PMP

1995 TO 1999

ROVER 200/400 15" ALLOY ROAD WHEEL



XW 92-96
RRP ex vat £142.86
SALE PRICE
ex vat inc vat
£42.55 £50.00
Part No. RRC10402MNH

ROVER 200 14" ALLOY ROAD WHEEL



RRP ex vat £159.76
SALE PRICE
ex vat inc vat
£42.55 £50.00
Part No. RRC117270MNH

VOODOO STYLE
6.0J X 14"
SILVER SPARKLE

ROVER 200 ROAD WHEEL FITTING KIT



RRP ex vat £102.97
SALE PRICE
ex vat inc vat
£25.53 £30.00
Part No. RRB100540

VOODOO STYLE WHEELS

ROVER 200/400 ALLOY WHEEL CENTRE



OCT 1989 TO OCT 1992
RRP ex vat £36.40
SALE PRICE
ex vat inc vat
£6.81 £8.00
Part No. DTC10002MNE

ROVER 200/400 LOCK SETS



RHD
5 DOOR/TOURER -
NOT CDL
XW VIN AD798420 ON
RRP ex vat £143.82
SALE PRICE
ex vat inc vat
£80.85 £95.00
Part No. CWB103280

RRP ex vat £143.82
SALE PRICE
ex vat inc vat
£80.85 £95.00
Part No. CWB10274MMM

RHD CABRIOLET
TO VIN AD798419
JAPAN XW



RRP ex vat £143.82
SALE PRICE
ex vat inc vat
£80.85 £95.00
Part No. CWB103240

RHD
3 DOOR - NOT CDL
XW VIN AD798420 ON

MG ROVER CLEARANCE BARGAINS

SAVE UP TO
93%
ON MG ROVER
PRICES!

Pick up a bargain today on these heavily discounted genuine MG Rover parts.
First come first served. Limited quantities of product available.
Parts will no longer be available when sold. Shipped anywhere worldwide.

Please check our website for latest availability & additional products.

ROVER 200 & 400

ROVER 200/400

SPOILERS



BOOT SPOILER
4 DOOR XW 92-96
NIGHTFIRE RED

RRP ex vat £400.38
SALE PRICE
ex vat inc vat
£63.83 £75.00

Part No. DFD10089CQ



TAILGATE SPOILER
ROVER 200
5 DOOR GTI

RRP ex vat £368
SALE PRICE
ex vat inc vat
£63.83 £75.00

Part Nos.
BRITISH RACING GREEN
DFD101110HNA
TAHITI BLUE
DFD101110JRJ



TAILGATE SPOILER
ROVER 216 GTI/220 GSI
XW OCT 92 TO FEB 96

RRP ex vat £432.67
SALE PRICE
ex vat inc vat
£63.83 £75.00

Part No. DFD101110NND



TAILGATE SPOILER
TOURER XW 96 ON
BLACK

RRP ex vat £153.14
SALE PRICE
ex vat inc vat
£63.83 £75.00

Part No. DFD101450PMD



TAILGATE SPOILER
ROVER 400
QUICK SILVER OR BLACK

RRP ex vat £341.44
SALE PRICE
ex vat inc vat
£51.06 £60.00

Part Nos.
QUICK SILVER DFD10089MNS
BLACK DFD10089PMF

ROVER 200/400/800

DOOR HANDLE



RH FRONT
BRITISH RACING GREEN

RRP ex vat £57.11
SALE PRICE
ex vat inc vat
£12.76 £14.99

Part No. CXB10114HNA



RH
OCT 1992 TO FEB 1996
NO BURGULAR ALARM
CARIBBEAN BLUE

RRP ex vat £50.56
SALE PRICE
ex vat inc vat
£17.02 £20.00

Part No. CXB10110UME

ROVER 200/400 XW

BACKLIGHT FINISHER

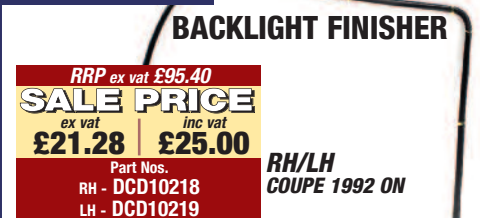

RRP ex vat £95.40
SALE PRICE
ex vat inc vat
£21.28 £25.00

Part Nos.
RH - DCD10218
LH - DCD10219

RH/LH
COUPE 1992 ON

ROVER 400 TOURER

TAILGATE SEAL



RRP ex vat £35.99
SALE PRICE
ex vat inc vat
£12.72 £14.95

Part No. CKE100760

ROVER 200/400

BOOT LID SEALS



CABRIOLET/COUPE
XW TO VIN AD653393

RRP ex vat £39.01
SALE PRICE
ex vat inc vat
£17.02 £20.00

Part No. CKE10048



CABRIOLET/COUPE
XW 92 ON

RRP ex vat £41.86
SALE PRICE
ex vat inc vat
£21.28 £25.00

Part No. CKE100770

ROVER 200/400

RH FRONT DOOR GLASS - RUN CHANNEL



3 DOOR SALOON
XW 92-96

RRP ex vat £59.35
SALE PRICE
ex vat inc vat
£17.02 £20.00

Part No. CFE10056

ROVER 200/400 XW

FRONT DOOR FINISHER



RRP ex vat £28.44
SALE PRICE
ex vat inc vat
£8.51 £10.00

Part Nos.
RH - DDC10070
LH - DDC10071

RH/LH
3 DOOR

ROVER 200/400 XW

FRONT MUDFLAP KIT



RRP ex vat £19.82
SALE PRICE
ex vat inc vat
£4.25 £4.99

Part No. CAS10040LOG

1992 TO 1996
GREY

ROVER 200/400

REAR LOWER PANEL ASSEMBLY



RRP ex vat £214.28
SALE PRICE
ex vat inc vat
£72.34 £85.00

Part No. AQA38002



ROVER 200
CABRIOLET/COUPE
XW

RRP ex vat £561.40
SALE PRICE
ex vat inc vat
£63.83 £75.00

Part No. AQA380230

ROVER 400 TOURER

ROVER 200 BACKLIGHT (HOOD)



CABRIOLET
XW 1992 TO 1996
GRANITE

RRP ex vat £467.78
SALE PRICE
ex vat inc vat
£250.00 £293.75

Part No. DSL10005LOY



CABRIOLET
XW 1996 ON
SMOKESTONE

RRP ex vat £467.78
SALE PRICE
ex vat inc vat
£250.00 £293.75

Part No. DSL10005LPR

ROVER 200/400

FRONT WINDSCREEN WIPER ARM



RH/LHD
COUPE
XW 1992 ON

RRP ex vat £19.82
SALE PRICE
ex vat inc vat
£8.51 £10.00

Part No. DKB10113

ROVER 200 GLOVE BOX LID BUFFER

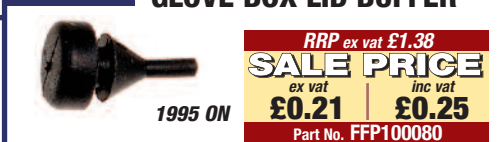

1995 ON

RRP ex vat £1.38
SALE PRICE
ex vat inc vat
£0.21 £0.25

Part No. FFP100080

ROVER 200/400

WIND DEFLECTORS



RRP ex vat £37.34
SALE PRICE
ex vat inc vat
£8.51 £10.00

Part No. VUB100080

400 TOURER
& XW 4 DOOR

ORDER BY PHONE: 01522 568000 / ON LINE: www.rimmerbros.co.uk / E-MAIL: mgrover@rimmerbros.co.uk

MG ROVER CLEARANCE BARGAINS

SAVE UP TO
93%
ON MG ROVER
PRICES!

Pick up a bargain today on these heavily discounted genuine MG Rover parts. First come first served. Limited quantities of product available. Parts will no longer be available when sold. Shipped anywhere worldwide.

Please check our website for latest availability & additional products.

ROVER 200/400

GEAR LEVER KNOB

1800/2000CC
PG1 GEARBOX



RRP ex vat £67.17

SALE PRICE

ex vat inc vat
£17.02 £20.00

Part No. UKJ0001TOPMA

ROVER 200/400

SPEEDO ASSEMBLY

KMH

ROVER 218/418

DIESEL SALOON

XW OCT 92 TO FEB 96

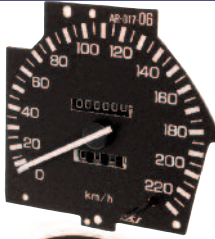

RRP ex vat £133.65

SALE PRICE

ex vat inc vat
£21.28 £25.00

Part No. YBC10075

**MPH
TOURER & COUPE 1800 VVC**

RRP ex vat £110.31

SALE PRICE

ex vat inc vat
£34.04 £40.00

Part No. YBC101180



ROVER 200/400

**STEERING
WHEEL**



RRP ex vat £174.03

SALE PRICE

ex vat inc vat
£34.04 £40.00

XW OCT 92 TO FEB 96
NO DRIVERS AIR BAG

Part No. EFP6834PMP

ROVER 200/400

**COLUMN
SWITCHES**



RRP ex vat £237.78

SALE PRICE

ex vat inc vat
£80.85 £95.00

COUPE/TOURER
FROM OCT 92 TO FEB 96

Part No. XPB100660PMP



XW 1992 TO 1996

RRP ex vat £104.75

SALE PRICE

ex vat inc vat
£34.00 £39.95

Part No. XPB10006

ROVER 200/400

**POWER STEERING
RACK**



RRP ex vat £411.84

SALE PRICE

ex vat inc vat
£106.38 £125.00

RHD
92-96 NOT 1.6
CABRIOLET/COUPE,
95 ON DIESEL ONLY

Part No. QEB003332E

ROVER 200/400

DRIVESHAFTS



RRP ex vat £70.00

SALE PRICE

ex vat inc vat
£29.79 £35.00

Part Nos.

RH - TDB10046P

LH - TDB10047P

RH/LH
1100/1400/1600
92 ON

ROVER 200/400/45

**FLOOR MAT
SETS**



RHD

XW TOURER

AVAILABLE IN BEIGE,
GREY OR BLACK

RRP ex vat £13.49

SALE PRICE

ex vat inc vat
£8.51 £10.00

Part Nos.

BEIGE - EAH102100SMJ

GREY - EAH102100LOY

BLACK - EAH102100PMA

LHD

ROVER 200/400 XW
BLACK

RRP ex vat £12.59

SALE PRICE

ex vat inc vat
£8.51 £10.00

Part No. EAH102110PMA

RHD

ROVER 200 XW BLACK

RRP ex vat £62.26

SALE PRICE

ex vat inc vat
£8.51 £10.00

Part No. EAH102700PMA

RRP ex vat £18.60

SALE PRICE

ex vat inc vat
£8.51 £10.00

Part No. EAH102710LOY

LHD

ROVER 200 XW GREY

COULD BE
ADAPTED
FOR RHD



LHD
ROVER 400 TOURER
1996 ON GREY

RRP ex vat £19.83

SALE PRICE

ex vat inc vat
£8.51 £10.00

Part No. EAH102110LNF

ROVER 200/400

**ACCELERATOR
CABLE**

RHD

200/214 SPI 8V

1992 TO 1996



RRP ex vat £75.82

SALE PRICE

ex vat inc vat
£17.02 £20.00

Part No. SBB10184

ROVER 200/400

BRAKE SERVO

1.4 ABS 2.0 DIESEL
OCT 1992 ON

RRP ex vat £181.91

SALE PRICE

ex vat inc vat
£80.85 £95.00

Part No. EJP1450EVA



ROVER 200/400

**HT LEAD
SPACER**



RRP ex vat £11.23

SALE PRICE

ex vat inc vat
£4.21 £4.95

Part No. NGD10016

2.0 LITRE T SERIES

ROVER 200/400

TOWING ELECTRIC KIT



RRP ex vat £100.90

SALE PRICE

ex vat inc vat
£42.55 £50.00

Part No. VUB104560

XW
13 PIN



RRP ex vat £36.03

SALE PRICE

ex vat inc vat
£12.77 £15.00

Part No. YWJ100600

COUPE & TOURER

ROVER 200/400

**BOLT - CRANKSHAFT
PULLEY**



RRP ex vat £3.07

SALE PRICE

ex vat inc vat
£0.85 £1.00

Part No. UAM7712

2000cc

ROVER 200/400

CRANKSHAFT KIT



2 LITRE PETROL
XW

RRP ex vat £814.25

SALE PRICE

ex vat inc vat
£106.38 £125.00

Part No. LFT10013

MG ROVER CLEARANCE BARGAINS

SAVE UP TO
93%
ON MG ROVER
PRICES!

Pick up a bargain today on these heavily discounted genuine MG Rover parts.
First come first served. Limited quantities of product available.
Parts will no longer be available when sold. Shipped anywhere worldwide.

Please check our website for latest availability & additional products.

ROVER 200 & 400

ROVER 200

REAR EXHAUSTS

ROVER 216 TO DEC 1989

RRP ex vat £40.59
SALE PRICE
ex vat inc vat
£17.02 £20.00
Part No. DBP3709EVA

RRP ex vat £40.91
SALE PRICE
ex vat inc vat
£17.02 £20.00
Part No. WCG033504EVA

RRP ex vat £31.76
SALE PRICE
ex vat inc vat
£12.77 £15.00
Part No. EGP1614EVA

ROVER 400

REAR EXHAUSTS

RRP ex vat £53.19
SALE PRICE
ex vat inc vat
£21.28 £25.00
Part No. WCG10051EVA

ROVER 200/400

FRONT PIPE ASSEMBLY

RRP ex vat £39.72
SALE PRICE
ex vat inc vat
£17.02 £20.00
Part No. WCD10214EVA

1400
VIN 244043 TO 474813

ROVER 200/400

EXHAUST - INTERMEDIATE

RRP ex vat £54.06
SALE PRICE
ex vat inc vat
£17.02 £20.00
Part No. EJP4034EVA

ROVER 213 RADIATOR

ROVER 200/25

HEATER ASSEMBLY RHD

RRP ex vat £226.04
SALE PRICE
ex vat inc vat
£63.83 £75.00
Part No. JEC102080

ROVER 200/400 XW

HEATER MATRIX LHD

RRP ex vat £357.25
SALE PRICE
ex vat inc vat
£42.55 £50.00
Part No. JEF10003

ROVER 200/400

INTERCOOLER/ PIPE ASSEMBLY

2 LITRE PETROL
T SERIES TURBO XW 92-96
RRP ex vat £421.22
SALE PRICE
ex vat inc vat
£85.11 £100.00
Part No. PCM10012

ROVER 200/400

SEAL KIT - MANUAL GEARBOX

RRP ex vat £33.01
SALE PRICE
ex vat inc vat
£12.77 £15.00
Part No. TRT100050

1800/2000cc

ROVER 200/400

EXHAUST MANIFOLDS

RRP ex vat £372.82
SALE PRICE
ex vat inc vat
£80.85 £95.00
Part No. LKC10072

XW 92-96
DIESEL

RRP ex vat £181.03
SALE PRICE
ex vat inc vat
£63.83 £75.00
Part No. LKC101600

216/416 GTI
XW 92-96
NO CAT DOHC

RRP ex vat £152.45
SALE PRICE
ex vat inc vat
£63.83 £75.00
Part No. LKC101690

216/416

ROVER 200/400 EXHAUST VALVE

2.0 PETROL
OCT 1989 TO OCT 1992

RRP ex vat £32.07
SALE PRICE
ex vat inc vat
£8.51 £10.00
Part No. LGH101150

ROVER 200/400

PAS PUMP

2.0 PETROL
XW

RRP ex vat £399.86
SALE PRICE
ex vat inc vat
£80.85 £95.00
Part No. QVB10037

ROVER 200/400

ECU FUEL IGNITION

RRP ex vat £231.02
SALE PRICE
ex vat inc vat
£63.83 £75.00
Part No. MKC103580N

1400 16V

ROVER 200/400

CRANK PULLEY

2.0 PETROL
T SERIES
WITH
AIR-CON

RRP ex vat £179.49
SALE PRICE
ex vat inc vat
£42.55 £50.00
Part No. LHG10034

ROVER 200

FLYWHEEL



RRP ex vat £251.52
SALE PRICE
ex vat inc vat
£34.04 £40.00
Part No. FDU2870

1.6 AUTO
OCT 1989
TO OCT
1992

ROVER 200/400

OIL PUMP



RRP ex vat £251.97
SALE PRICE
ex vat inc vat
£42.55 £50.00
Part No. LPF100980

ROVER 200

WATER PUMP



ROVER 218 DIESEL
1700CC FROM ENG. NO. 4016154
1900CC FROM ENG. NO. 4014120

RRP ex vat £54.95
SALE PRICE
ex vat inc vat
£17.02 £20.00
Part No. PEB101780EVA

ROVER 200/400 XW

FUEL PUMP



2 LITRE T SERIES
TURBO PETROL
220 TURBO
1992 TO 1996

RRP ex vat £296.05
SALE PRICE
ex vat inc vat
£63.83 £75.00
Part No. WFX10033

ROVER 200/400

BRAKE VACUUM PUMP



DIESEL
OCT '92
RRP ex vat £184.99
SALE PRICE
ex vat inc vat
£63.83 £75.00
Part No. EJP8002

MG ROVER CLEARANCE BARGAINS

SAVE UP TO
93%
ON MG ROVER
PRICES!

Pick up a bargain today on these heavily discounted genuine MG Rover parts. First come first served. Limited quantities of product available. Parts will no longer be available when sold. Shipped anywhere worldwide.

Please check our website for latest availability & additional products.

ROVER 600 ENGINE ASSEMBLY - DIESEL

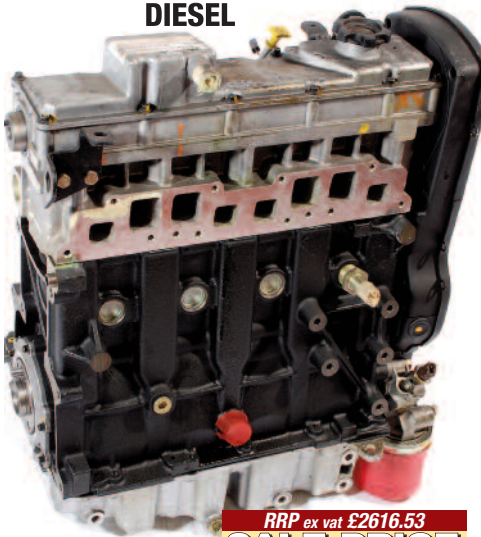

RRP ex vat £2616.53
SALE PRICE
ex vat inc vat
£995.00 £1169.13
Part No. LBB110660N

ROVER 600 RADIATOR



RRP ex vat £138.11
SALE PRICE
ex vat inc vat
£85.11 £100.00
Part No. PCC001077EVA
2.3 HONDA EXCEPT TURBO MANUAL & AUTOMATIC

ROVER 600 CRANKSHAFT KIT



RRP ex vat £814.25
SALE PRICE
ex vat inc vat
£106.38 £125.00
Part No. LFT10013
2 LITRE PETROL

ROVER 600 BOLT - CRANKSHAFT PULLEY



RRP ex vat £3.07
SALE PRICE
ex vat inc vat
£0.85 £1.00
Part No. UAM7712
2000CC

ROVER 600 ENGINE OIL SUMP ASSEMBLY



RRP ex vat £192.45
SALE PRICE
ex vat inc vat
£34.04 £40.00
Part No. LSB102070
2 LITRE L SERIES DIESEL

ROVER 600 CLUTCH RELEASE BEARING



RRP ex vat £141.01
SALE PRICE
ex vat inc vat
£42.55 £50.00
Part No. UTJ100080EVA
HONDA 1800/2000/2300CC NOT TURBO

ROVER 600 STEERING COLUMN RHD



RRP ex vat £173.60
SALE PRICE
ex vat inc vat
£63.83 £75.00
Part No. QMB101050PNC

ROVER 600 HT LEAD SPACER



RRP ex vat £11.23
SALE PRICE
ex vat inc vat
£4.21 £4.95
Part No. NGD10016
PETROL TURBO

ROVER 600 POWER STEERING RACK - RHD



RRP ex vat £293.97
SALE PRICE
ex vat inc vat
£106.38 £125.00
Part No. QEB003384E
VIN BM246797 ON

ROVER 600 OIL PUMP

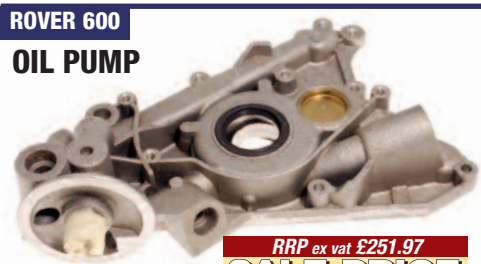

RRP ex vat £251.97
SALE PRICE
ex vat inc vat
£42.55 £50.00
Part No. LPF100980
2 LITRE PETROL T SERIES

ROVER 600 HEATER BLOWER ASSEMBLY LHD



RRP ex vat £296.51
SALE PRICE
ex vat inc vat
£42.55 £50.00
Part No. JGB100780

ROVER 600 FRONT LOWER ARMS



RRP ex vat £248.39
SALE PRICE
ex vat inc vat
£34.04 £40.00
Part No. RBJ100690-720
PAIR

ROVER 600 CRANK PULLEY



RRP ex vat £179.49
SALE PRICE
ex vat inc vat
£42.55 £50.00
Part No. LHG10034
2 LITRE PETROL T SERIES WITH AIR-CON

ROVER 600 REAR BRAKE PAD SHIM KIT



RRP ex vat £10.00
SALE PRICE
ex vat inc vat
£4.25 £4.99
Part No. ZUA000031

ROVER 600 FRONT LOWER ARMS RH



RRP ex vat £128.39
SALE PRICE
ex vat inc vat
£24.95 £29.32
Part No. RBJ100690
RH

ROVER 600 FRONT LOWER ARMS LH



RRP ex vat £120.00
SALE PRICE
ex vat inc vat
£24.95 £29.32
Part No. RBJ100720
LH

ROVER 600 LH REAR KNUCKLE JOINT



RRP ex vat £103.66
SALE PRICE
ex vat inc vat
£21.28 £25.00
Part No. RHF100090
DIESEL ANTI-LOCK BRAKES

MG ROVER CLEARANCE BARGAINS

SAVE UP TO
93%
ON MG ROVER
PRICES!

Pick up a bargain today on these heavily discounted genuine MG Rover parts.
First come first served. Limited quantities of product available.
Parts will no longer be available when sold. Shipped anywhere worldwide.

Please check our website for latest availability & additional products.

ROVER 600

ROVER 600

FRONT BUMPER



620i
TO VIN AM130951
DARK GREY

RRP ex vat £211.96
SALE PRICE
ex vat inc vat
£63.83 £75.00
Part No. DPC101110LPU

ROVER 600

LH FRONT DOOR HANDLE



RRP ex vat £45.22
SALE PRICE
ex vat inc vat
£21.28 £25.00
Part No. CXB101370HAF

PEARLESCENT
BRITISH RACING GREEN

ROVER 600

SUN ROOF WIND DEFLECTOR



RRP ex vat £42.66
SALE PRICE
ex vat inc vat
£17.02 £20.00
Part No. EFJ100180

ROVER 600

REAR ANTI ROLL BAR



DIESEL TURBO
L SERIES

RRP ex vat £57.77
SALE PRICE
ex vat inc vat
£25.53 £30.00
Part No. RHP100020

ROVER 600

BOOD LID ASSEMBLY



VEHICLE WITH REAR
BOOT SPOILER

RRP ex vat £295.36
SALE PRICE
ex vat inc vat
£80.85 £95.00
Part No. BMD100010

ROVER 600

LH FRONT DOOR SEAL



TO VIN AM144844

RRP ex vat £54.98
SALE PRICE
ex vat inc vat
£17.02 £20.00
Part No. CFB100840

ROVER 600

FRONT PIPE ASSEMBLY



2 LITRE PETROL TURBO
TO AM246796

RRP ex vat £88.19
SALE PRICE
ex vat inc vat
£34.04 £40.00
Part No. WCD103330EVA

ROVER 600

FABRIC MATS



RRP ex vat £18.75
SALE PRICE
ex vat inc vat
£10.64 £12.50
Part No. EAH102630SMJ

RHD

PREMIUM BEIGE

ROVER 600

REAR RUBBER MATS



RRP ex vat £20.95
SALE PRICE
ex vat inc vat
£6.81 £8.00
Part No. EAH101820LNF

ROVER 600

BONNET BUFFER



RRP ex vat £0.81
SALE PRICE
ex vat inc vat
£0.42 £0.49
Part No. CJM000050

ROVER 600

TOWING ELECTRIC KITS



13 PIN

RRP ex vat £133.47
SALE PRICE
ex vat inc vat
£42.55 £50.00
Part No. VUB104600

ROVER 600

BOOT TIDY NET - SIDE



RRP ex vat £5.39
SALE PRICE
ex vat inc vat
£2.13 £2.50
Part No. ESK100170

ROVER 600

SNOW CHAINS



FITS 195/70/14
195/65/15 205/55/15
215/50/15 205/50/16

RRP ex vat £72.92
SALE PRICE
ex vat inc vat
£34.04 £40.00
Part No. VUJ10001

MG ROVER CLEARANCE BARGAINS

SAVE UP TO
93%
ON MG ROVER
PRICES!

Pick up a bargain today on these heavily discounted genuine MG Rover parts. First come first served. Limited quantities of product available. Parts will no longer be available when sold. Shipped anywhere worldwide.

Please check our website for latest availability & additional products.

ROVER 800 CRANKSHAFT KIT



2 LITRE PETROL

RRP ex vat £814.25
SALE PRICE
ex vat inc vat
£106.38 £125.00

Part No. LFT10013

ROVER 800 DRIVE PLATE ASSEMBLY



825 PETROL AUTO

RRP ex vat £132.49
SALE PRICE
ex vat inc vat
£34.04 £40.00

Part No. TPB100120

ROVER 800RS FRONT RUBBER MATS



RRP ex vat £28.74
SALE PRICE
ex vat inc vat
£8.51 £10.00

LHD 1991 ON PAIR
Part No. EAH102270LNF

ROVER 800 CAMSHAFT



2000CC

RRP ex vat £135.97
SALE PRICE
ex vat inc vat
£85.11 £100.00

Part No. UAM1662

ROVER 800RS FLYWHEEL ASSEMBLY



2500 PETROL

RRP ex vat £94.26
SALE PRICE
ex vat inc vat
£25.53 £30.00

Part No. PSD102340

ROVER 800RS FABRIC MAT SETS



RRP ex vat £17.92
SALE PRICE
ex vat inc vat
£10.64 £12.50

RHD PREMIUM BEIGE
Part No. EAH102560SMJ

ROVER 820 HT LEAD KIT



VITESSE 2 LITRE T SERIES ENGINE 1991 ON

RRP ex vat £18.66
SALE PRICE
ex vat inc vat
£6.81 £8.00

Part No. NGC102300EVA

LHD PREMIUM GREY

RRP ex vat £18.43
SALE PRICE
ex vat inc vat
£10.64 £12.50

Part No. EAH102670LOY

ROVER 800 BOLT - CRANKSHAFT PULLEY



2000CC

RRP ex vat £3.07
SALE PRICE
ex vat inc vat
£0.85 £1.00

Part No. UAM7712

ROVER 800 CYLINDER HEAD GASKET



2.0 CARB

RRP ex vat £44.18
SALE PRICE
ex vat inc vat
£12.77 £15.00

Part No. LVQ701162EVA

RHD & LHD STANDARD GREY

RRP ex vat £27.31
SALE PRICE
ex vat inc vat
£8.51 £10.00

Part Nos.
RHD - EAH102640LOY
LHD - EAH102590LOY

ROVER 800 POWER STEERING RACKS



RRP ex vat £446.60
SALE PRICE
ex vat inc vat
£165.96 £195.00

RHD 820 TURBO OCT 1991 ON NOT SHOWN
Part No. QEB003373E

ROVER 800 OIL PUMP



2 LITRE PETROL T SERIES

RRP ex vat £251.97
SALE PRICE
ex vat inc vat
£42.55 £50.00

Part No. LPF100980

ROVER 800RS LOADSPACE DOG GUARD



RRP ex vat £29.03
SALE PRICE
ex vat inc vat
£8.51 £10.00

5 DOOR 1991 ON
Part No. ESH10005

ROVER 800 HT LEAD SPACER



2.0 LITRE T SERIES

RRP ex vat £265.36
SALE PRICE
ex vat inc vat
£80.85 £95.00

RHD 827 OCT 1991 TO OCT 1996 NOT SHOWN
Part No. QEB000362E

ROVER 800 CRANK PULLEY



2.0 PETROL T SERIES WITH AIR-CON

RRP ex vat £179.49
SALE PRICE
ex vat inc vat
£42.55 £50.00

Part No. LHG10034

ROVER 800 SNOW CHAINS



RRP ex vat £72.95
SALE PRICE
ex vat inc vat
£34.04 £40.00

FITS 195/70/14 195/65/15 205/55/15 215/50/15 205/50/16
Part No. VUJ10001

ROVER 600 HT LEAD SPACER



2.0 LITRE T SERIES

RRP ex vat £11.23
SALE PRICE
ex vat inc vat
£4.21 £4.95

Part No. NGD10016

ROVER 800 CYLINDER LINER



825 VM DIESEL 1991 ON

RRP ex vat £87.20
SALE PRICE
ex vat inc vat
£42.55 £50.00

Part No. LCJ10006

ROVER 800 RH FRONT LOWER ARM



2.0 VITESSE

RRP ex vat £101.82
SALE PRICE
ex vat inc vat
£34.04 £40.00

Part No. RBJ100740

ROVER 800 FRONT CALIPER HOUSING



RH 1991 TO 1996

RRP ex vat £79.63
SALE PRICE
ex vat inc vat
£34.04 £40.00

Part No. SEG10003EVA

MG ROVER CLEARANCE BARGAINS

SAVE UP TO
93%
ON MG ROVER
PRICES!

Pick up a bargain today on these heavily discounted genuine MG Rover parts.
First come first served. Limited quantities of product available.
Parts will no longer be available when sold. Shipped anywhere worldwide.

Please check our website for latest availability & additional products.

ROVER 800

ROVER 800 (RS) DOOR ASSEMBLIES

REDUCED



RRP ex vat £514.71
SALE PRICE
ex vat inc vat
£63.83 £75.00

Part Nos.
RH - BDA410440
LH - BDA410450

FRONT RH & LH
1991 ON

REDUCED



RRP ex vat £530.15
SALE PRICE
ex vat inc vat
£85.11 £100.00

Part No. BFA410300

REAR RH
1991 ON

REDUCED



RRP ex vat £514.71
SALE PRICE
ex vat inc vat
£63.83 £75.00

Part No. BFA410310

REAR LH
1991 ON

REDUCED



RRP ex vat £514.71
SALE PRICE
ex vat inc vat
£63.83 £75.00

Part Nos.
RH - BDA41036
LH - BDA41037

RH & LH
COUPE 1991 ON

ROVER 800 (RS) FRONT DOOR SKINS

REDUCED



RRP ex vat £111.49
SALE PRICE
ex vat inc vat
£21.28 £25.00

Part Nos.
RH - BDA41010
LH - BDA41011

FRONT RH & LH
1991 ON

ROVER 800RS FRONT WING



RRP ex vat £185.24
SALE PRICE
ex vat inc vat
£42.55 £50.00

Part No. ABS41030

RH
2 DOOR COUPE
1991 TO 1996

ROVER 800RS BONNET ASSEMBLY



RRP ex vat £181.76
SALE PRICE
ex vat inc vat
£63.83 £75.00

Part No. BKA41012

1991 ON

ROVER 800 (RS) BOOT LIDS



RRP ex vat £161.00
SALE PRICE
ex vat inc vat
£42.55 £50.00

Part No. BMD37002

TO 1991



RRP ex vat £363.53
SALE PRICE
ex vat inc vat
£63.83 £75.00

Part No. BMD410040

RS SALOON (1991 ON)
FROM VIN AM194917

ROVER 800RS GLASS MODULE



RRP ex vat £729.39
SALE PRICE
ex vat inc vat
£225.00 £264.38

Part No. CUV100220

RH
COUPE
OCT 1991 ON

ROVER 800 HEADLAMP ASSEMBLIES



RRP ex vat £164.96
SALE PRICE
ex vat inc vat
£34.04 £40.00

Part No. DCP8789

LH/RHD
MK1 TO VIN 276671



RRP ex vat £174.89
SALE PRICE
ex vat inc vat
£34.04 £40.00

Part No. DCP8790

RH/LHD
MK1 TO VIN 276671

ROVER 800 HEADLAMP PARTS KIT



RRP ex vat £43.13
SALE PRICE
ex vat inc vat
£8.51 £10.00

Part No. XBQ10047

1991 ON

ROVER 800 DOOR HANDLES



RRP ex vat £44.55
SALE PRICE
ex vat inc vat
£21.28 £25.00

Part No. CXB10105GMN

LH REAR
RS - 1991 TO 1996
WHITE GOLD



RRP ex vat £45.31
SALE PRICE
ex vat inc vat
£17.02 £20.00

Part No. CXB101860LAL

RH REAR
SALOON - 1996 ON
PEWTER



RRP ex vat £57.11
SALE PRICE
ex vat inc vat
£12.76 £14.99

Part No. CXB10114HNA

RH FRONT
BRITISH RACING GREEN

ROVER 800 INTERMEDIATE PIPES



RRP ex vat £70.52
SALE PRICE
ex vat inc vat
£21.28 £25.00

Part No. WCE102070EVA

2.7 LITRE
1991 TO 1996
JAPAN



RRP ex vat £53.35
SALE PRICE
ex vat inc vat
£17.02 £20.00

Part No. EMP9109EVA

825 VM DIESEL
1991 TO JAN 1996

ROVER 800 EXHAUST VALVE



RRP ex vat £32.07
SALE PRICE
ex vat inc vat
£8.51 £10.00

Part No. LGH101150

2.0 PETROL

ROVER 800 TOWING ELECTRICS KIT



RRP ex vat £36.03
SALE PRICE
ex vat inc vat
£12.77 £15.00

Part No. YWJ100600

1996 ON

MG ROVER CLEARANCE BARGAINS

SAVE UP TO
93%
ON MG ROVER
PRICES!

Pick up a bargain today on these heavily discounted genuine MG Rover parts. First come first served. Limited quantities of product available. Parts will no longer be available when sold. Shipped anywhere worldwide.

Please check our website for latest availability & additional products.

MAESTRO REAR DOOR ASSEMBLIES

RRP ex vat £279.76
SALE PRICE
ex vat inc vat
£125.00 £146.88
Part No. BFA31003

LH REAR
1986 ON



RRP ex vat £243.82
SALE PRICE
ex vat inc vat
£100.00 £117.50
Part No. BFA31002

RH REAR



MAESTRO DOORSKINS

RRP ex vat £73.88
SALE PRICE
ex vat inc vat
£25.52 £30.00
Part No. BEP971

LH REAR



MAESTRO FRONT WINGS

RRP ex vat £109.58
SALE PRICE
ex vat inc vat
£34.04 £40.00
Part Nos.
RH BEP2386, LH BEP2387

RH & LH
1986 ON



MAESTRO BUMPER ASSEMBLIES

RRP ex vat £131.39
SALE PRICE
ex vat inc vat
£42.55 £50.00
Part No. CHM431

FRONT
INC MG EFI



RRP ex vat £189.71
SALE PRICE
ex vat inc vat
£65.22 £76.63
Part No. CHM432

REAR



MAESTRO REAR LOWER PANEL

RRP ex vat £249.16
SALE PRICE
ex vat inc vat
£63.83 £75.00
Part No. BEP719

MOULDED BUMPER MODELS



MAESTRO LOWER REAR BODY PANEL

RRP ex vat £43.66
SALE PRICE
ex vat inc vat
£14.89 £17.50
Part No. BEP1012



MAESTRO OUTER SILL PANEL

RRP ex vat £37.39
SALE PRICE
ex vat inc vat
£10.64 £12.50
Part No. BEP2142

RH
1986 ON



MAESTRO TOP PANEL CROSSMEMBER CLOSING

RRP ex vat £26.98
SALE PRICE
ex vat inc vat
£8.51 £10.00
Part No. ABF31002

1986 ON



MAESTRO TAILGATE

RRP ex vat £239.40
SALE PRICE
ex vat inc vat
£127.62 £149.95
Part No. BEP2349



MAESTRO TAILGATE GLASS

RRP ex vat £268.24
SALE PRICE
ex vat inc vat
£42.55 £50.00
Part No. PAM1923

TINTED



MAESTRO TAILGATE SEAL

RRP ex vat £39.51
SALE PRICE
ex vat inc vat
£21.28 £25.00
Part No. CKE10010



MAESTRO TAILGATE GLASS SURROUND

RRP ex vat £68.42
SALE PRICE
ex vat inc vat
£17.02 £20.00
Part No. JRC2378



MAESTRO TAIL LAMP SURROUND

RRP ex vat £35.37
SALE PRICE
ex vat inc vat
£8.51 £10.00
Part Nos.
RH - BEP708, LH - BEP709

RH OR LH 1986 ON



MAESTRO DOOR HANDLE

RRP ex vat £44.67
SALE PRICE
ex vat inc vat
£12.77 £15.00
Part No. CXB10073PMD

LH FRONT/REAR
BLACK PLASTIC



MAESTRO DOOR WINDOW REGULATORS

RRP ex vat £74.75
SALE PRICE
ex vat inc vat
£17.02 £20.00
Part No. CUH10166

RH FRONT
MANUAL
VIN 685818 ON



RRP ex vat £74.75
SALE PRICE
ex vat inc vat
£34.04 £40.00
Part No. CDP6343

LH FRONT
ELECTRIC



RRP ex vat £52.21
SALE PRICE
ex vat inc vat
£21.28 £25.00
Part No. CVH10079

LH REAR



MAESTRO DOOR MIRRORS

RRP ex vat £77.64
SALE PRICE
ex vat inc vat
£21.28 £25.00
Part No. CRB10162

LHD - RH
VIN 648195 ON
CONVEX



RRP ex vat £65.31
SALE PRICE
ex vat inc vat
£21.27 £24.99
Part No. CRB10163

LH
CONVEX GLASS MANUAL



MAESTRO DOOR MIRROR GLASS

RRP ex vat £31.38
SALE PRICE
ex vat inc vat
£4.25 £4.99
Part Nos.
RH - CDU2792, LH - CDU2791

RH OR LH
ELECTRIC
CONVEX



RRP ex vat £19.47
SALE PRICE
ex vat inc vat
£4.25 £4.99
Part Nos.
RH - CDU2786, LH - CDU2785

RH OR LH
MANUAL
FLAT



RRP ex vat £23.49
SALE PRICE
ex vat inc vat
£4.25 £4.99
Part No. CDU2788

RH
ELECTRIC
FLAT



MAESTRO SUN VISOR

RRP ex vat £21.69
SALE PRICE
ex vat inc vat
£8.51 £10.00
Part No. EDQ101990LNG



MG ROVER CLEARANCE BARGAINS

SAVE UP TO
93%
ON MG ROVER
PRICES!

MAESTRO

Pick up a bargain today on these heavily discounted genuine MG Rover parts. First come first served. Limited quantities of product available. Parts will no longer be available when sold. Shipped anywhere worldwide.

Please check our website for latest availability & additional products.

MAESTRO REAR EXHAUST



1.3/1.6 LITRE
HLS, HLE, L, AUTO & VDP 1983 ON

RRP ex vat	£9.42
SALE PRICE	
ex vat	£6.38
inc vat	£7.50

Part No. WCG003969EVA

MAESTRO INTERMEDIATE PIPES



1.3/1.6 LITRE
HLS, HLE, L, AUTO & VDP 1983 ON

RRP ex vat	£17.96
SALE PRICE	
ex vat	£8.51
inc vat	£10.00

Part No. WCE003968EVA

MAESTRO DIESEL SALOON 1986 ON



RRP ex vat	£38.86
SALE PRICE	
ex vat	£17.02
inc vat	£20.00

Part No. WCE033537EVA

MAESTRO FRONT PIPE ASSEMBLIES

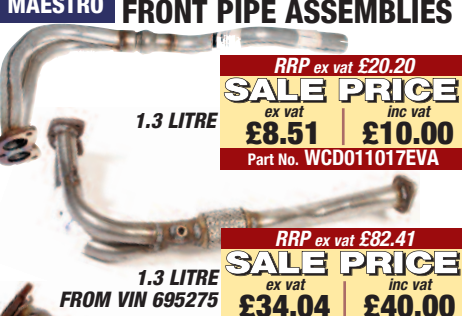

1.3 LITRE

RRP ex vat	£20.20
SALE PRICE	
ex vat	£8.51
inc vat	£10.00

Part No. WCD011017EVA

1.3 LITRE
FROM VIN 695275

RRP ex vat	£82.41
SALE PRICE	
ex vat	£34.04
inc vat	£40.00

Part No. WCD012070EVA

MAESTRO DIESEL EXG. TURBO FROM VIN 439586



RRP ex vat	£27.15
SALE PRICE	
ex vat	£10.64
inc vat	£12.50

Part No. WCD011074EVA

MAESTRO CAMSHAFT 2000CC



RRP ex vat	£135.97
SALE PRICE	
ex vat	£85.11
inc vat	£100.00

Part No. UAM1662

MAESTRO ACCELERATOR CABLE



1600CC RHD

RRP ex vat	£21.63
SALE PRICE	
ex vat	£8.51
inc vat	£10.00

Part No. NAM7898

MAESTRO OIL PIPE



2.0 TURBO DIESEL 1986 ON

RRP ex vat	£56.39
SALE PRICE	
ex vat	£21.27
inc vat	£25.00

Part No. PBH10005

MAESTRO FUEL TANKS



1.3/1.6 LITRE

RRP ex vat	£325.26
SALE PRICE	
ex vat	£51.06
inc vat	£60.00

Part No. CRC9291

MAESTRO DIESEL VAN



RRP ex vat	£284.52
SALE PRICE	
ex vat	£51.06
inc vat	£60.00

Part No. CRC9319

MAESTRO PUMP ASSEMBLY - VACUUM



DIESEL

RRP ex vat	£227.03
SALE PRICE	
ex vat	£80.85
inc vat	£95.00

Part No. ADU9631

MAESTRO HEAD GASKET SET



2.0 LITRE TURBO

RRP ex vat	£81.11
SALE PRICE	
ex vat	£59.95
inc vat	£70.45

Part No. LVQ701177EVA

MAESTRO FLYWHEEL



2 LITRE PETROL

RRP ex vat	£173.19
SALE PRICE	
ex vat	£25.53
inc vat	£30.00

Part No. PSD101580

MAESTRO HEADLAMP LENS



RHD RH/LH SALOON

RRP ex vat	£24.22
SALE PRICE	
ex vat	£12.77
inc vat	£15.00

Part Nos. RH BAU4482, LH BAU4481

MAESTRO PAS PUMP



2.0 DIESEL

RRP ex vat	£428.06
SALE PRICE	
ex vat	£80.85
inc vat	£95.00

Part No. QVB10014

MAESTRO INJECTOR FUEL DELIVERY



2 LITRE EFI 1986 ON

RRP ex vat	£96.03
SALE PRICE	
ex vat	£42.55
inc vat	£50.00

Part No. AHU2947

MAESTRO FRONT STRUTS



1988 ON MG 1984 ON

RRP ex vat	£25.62
SALE PRICE	
ex vat	£17.02
inc vat	£20.00

Part No. RND072530EVA

MAESTRO DIESEL 1986 TO 1995



RRP ex vat	£35.52
SALE PRICE	
ex vat	£17.02
inc vat	£20.00

Part No. RND072554EVA

MAESTRO WHEEL TRIMS



1.6 BASE NOV 88 ON SILVER

RRP ex vat	£18.33
SALE PRICE	
ex vat	£6.38
inc vat	£7.50

Part No. NAM9107MNE

MAESTRO VIN 607035 ON DIAMOND WHITE



RRP ex vat	£16.27
SALE PRICE	
ex vat	£6.38
inc vat	£7.50

Part No. NAM9107NMN

MAESTRO ENGINE MOUNTINGS



FRONT EFI JAN 1986 ON

RRP ex vat	£88.58
SALE PRICE	
ex vat	£21.27
inc vat	£24.99

Part No. CRC8136

MAESTRO LH 2.0 CARB FROM VIN 545366



RRP ex vat	£95.89
SALE PRICE	
ex vat	£21.27
inc vat	£24.99

Part No. CRC8131

MAESTRO BOLT - THERMOSTAT HOUSING



1.3 LITRE

RRP ex vat	£8.23
SALE PRICE	
ex vat	£0.85
inc vat	£1.00

Part No. TAM1369

MAESTRO STUD - EXHAUST MANIFOLD



1.3 LITRE

RRP ex vat	£0.90
SALE PRICE	
ex vat	£0.42
inc vat	£0.49

Part No. TE108060

MAESTRO AERIAL



RRP ex vat	£32.21
SALE PRICE	
ex vat	£8.51
inc vat	£10.00

Part No. EEP9

MAESTRO WHEELBRACE



RRP ex vat	£16.92
SALE PRICE	
ex vat	£6.38
inc vat	£7.50

Part No. ACA9913

MG ROVER CLEARANCE BARGAINS

SAVE UP TO
93%
ON MG ROVER
PRICES!

Pick up a bargain today on these heavily discounted genuine MG Rover parts. First come first served. Limited quantities of product available. Parts will no longer be available when sold. Shipped anywhere worldwide.

Please check our website for latest availability & additional products.

MONTEGO

DOOR SHELL ASSEMBLIES

LH FRONT 1988 ON

RRP ex vat £292.65
SALE PRICE
ex vat **£100.00** inc vat **£117.50**
Part No. BDA32005



RH REAR ESTATE 1988 ON

RRP ex vat £372.73
SALE PRICE
ex vat **£85.11** inc vat **£100.00**
Part No. BFA32008



MONTEGO

BONNET PANEL

1988 ON

RRP ex vat £210.17
SALE PRICE
ex vat **£80.85** inc vat **£95.00**
Part No. BKA32002



MONTEGO

LH DOOR HANDLE

FRONT/REAR BLACK PLASTIC

RRP ex vat £44.67
SALE PRICE
ex vat **£12.77** inc vat **£15.00**
Part No. CXB10073PMD



MONTEGO

WINDSCREEN

GREEN TINT WITH BLUE SHADE VIN 544454 ON

RRP ex vat £205.99
SALE PRICE
ex vat **£42.55** inc vat **£50.00**
Part No. CMB10024



MONTEGO

LH REAR WINDOW REGULATOR

SALOON FROM VIN 628725

RRP ex vat £52.21
SALE PRICE
ex vat **£21.28** inc vat **£25.00**
Part No. CVH10079



MONTEGO

DOOR SKINS

RH FRONT 1988 ON

RRP ex vat £101.16
SALE PRICE
ex vat **£42.55** inc vat **£50.00**
Part No. BDA32010



MONTEGO

TAILGATE ASSEMBLY - ESTATE

RRP ex vat £324.97
SALE PRICE
ex vat **£106.38** inc vat **£125.00**
Part No. GDP2302



MONTEGO

REAR LAMP GASKET

SALOON FROM VIN 628725

RRP ex vat £4.79
SALE PRICE
ex vat **£1.70** inc vat **£2.00**
Part No. XFH10012



MONTEGO

DOOR SKINS

LH REAR

RRP ex vat £94.16
SALE PRICE
ex vat **£34.04** inc vat **£40.00**
Part No. BFA32017



MONTEGO

REAR BUMPER ASSEMBLY - ESTATE

RRP ex vat £169.05
SALE PRICE
ex vat **£42.55** inc vat **£50.00**
Part No. CHM430



MONTEGO

DOOR MIRROR GLASSES

RH OR LH ELECTRIC CONVEX

RRP ex vat £31.38
SALE PRICE
ex vat **£4.25** inc vat **£4.99**
Part Nos. RH - CDU2792, LH - CDU2791



MONTEGO

LH FRONT WING

RRP ex vat £135.76
SALE PRICE
ex vat **£42.55** inc vat **£50.00**
Part No. CDP1885



MONTEGO

REAR LOWER PANEL - SALOON

RRP ex vat £160.49
SALE PRICE
ex vat **£80.85** inc vat **£95.00**
Part No. CDP1122



MONTEGO

REAR MIRROR GLASSES

RH OR LH MANUAL FLAT

RRP ex vat £19.47
SALE PRICE
ex vat **£4.25** inc vat **£4.99**
Part Nos. RH - CDU2786, LH - CDU2785



MONTEGO

BOOT LID

RRP ex vat £261.66
SALE PRICE
ex vat **£85.11** inc vat **£100.00**
Part No. CDP1141 TO 1986



MONTEGO

DOOR MIRROR

RH - RHD ELECTRIC HL & MG VIN 335364 ON BLACK

RRP ex vat £120.81
SALE PRICE
ex vat **£21.28** inc vat **£25.00**
Part No. JPC9284



MONTEGO

REAR MIRROR GLASSES

RH ELECTRIC FLAT

RRP ex vat £23.49
SALE PRICE
ex vat **£4.25** inc vat **£4.99**
Part No. CDU2788



MONTEGO

BONNET FINISHER

VDP & MAYFAIR

RRP ex vat £43.25
SALE PRICE
ex vat **£17.02** inc vat **£20.00**
Part No. JRC4982



MG ROVER CLEARANCE BARGAINS

SAVE UP TO
93%
ON MG ROVER
PRICES!

MONTEGO

Pick up a bargain today on these heavily discounted genuine MG Rover parts. First come first served. Limited quantities of product available. Parts will no longer be available when sold. Shipped anywhere worldwide.

Please check our website for latest availability & additional products.

MONTEGO
BOLT - THERMOSTAT HOUSING



1.3 LITRE

RRP ex vat £8.23
SALE PRICE
ex vat inc vat
£0.85 £1.00

Part No. TAM1369

MONTEGO
WHEELBRACE



RRP ex vat £16.92
SALE PRICE
ex vat inc vat
£6.38 £7.50

Part No. ACA9913

MONTEGO
PAS PUMP
2.0 DIESEL



RRP ex vat £428.06
SALE PRICE
ex vat inc vat
£80.85 £95.00

Part No. QVB10014

MONTEGO
ECU FUEL/IGNITION



2 LITRE EFI

RRP ex vat £276.31
SALE PRICE
ex vat inc vat
£80.85 £95.00

Part No. AUU1566E

MONTEGO
OIL PIPE



2.0 TURBO DIESEL
1989 ON

RRP ex vat £56.39
SALE PRICE
ex vat inc vat
£21.27 £24.99

Part No. PBH10005

MONTEGO
HEATER BLOWER ASSEMBLY



LHD
1988 ON

RRP ex vat £147.92
SALE PRICE
ex vat inc vat
£34.04 £40.00

Part No. JGC10007

MONTEGO
ENGINE MOUNTINGS
FRONT
2 LITRE NOT TURBO
JAN 1986 ON



RRP ex vat £88.58
SALE PRICE
ex vat inc vat
£21.27 £24.99

Part No. CRC8136

MONTEGO
INJECTOR FUEL DELIVERY
2 LITRE EFI
1986 ON



LH
1.6/2.0 MANUAL
NOV 1988 ON

RRP ex vat £95.89
SALE PRICE
ex vat inc vat
£21.27 £24.99

Part No. CRC8131

MONTEGO
LH FRONT SWIVEL HUB
1986 ON



RRP ex vat £96.03
SALE PRICE
ex vat inc vat
£42.55 £50.00

Part No. AHU2947

MONTEGO
CAMSHAFT
2000CC



RRP ex vat £216.03
SALE PRICE
ex vat inc vat
£42.55 £50.00

Part No. NAM6383

MONTEGO
REAR EXHAUSTS
2 LITRE DIESEL
1988 ON



RRP ex vat £21.61
SALE PRICE
ex vat inc vat
£14.89 £17.50

Part No. CRC7789EVA

MONTEGO
REAR EXHAUSTS
1.6 LITRE



RRP ex vat £28.31
SALE PRICE
ex vat inc vat
£12.55 £14.75

Part No. WCG033086EVA

MONTEGO
REAR EXHAUSTS
2.0 CARB
1985 ON



RRP ex vat £30.02
SALE PRICE
ex vat inc vat
£12.55 £14.75

Part No. WCG033092EVA

MONTEGO
EXHAUST INTERMEDIATES
1987 TO 1992
SALOON/ESTATE
2.0 MG EFI/GSI



RRP ex vat £29.15
SALE PRICE
ex vat inc vat
£17.02 £20.00

Part No. WCE033225EVA

MONTEGO
EXHAUST INTERMEDIATES
1600 SALOON
1986 ON



RRP ex vat £25.70
SALE PRICE
ex vat inc vat
£10.64 £12.50

Part No. WCE033241EVA

MONTEGO
FRONT PIPE ASSEMBLY
1.3 LITRE



RRP ex vat £20.20
SALE PRICE
ex vat inc vat
£8.51 £10.00

Part No. WCD011017EVA

MONTEGO
CAMSHAFT
2000CC



RRP ex vat £135.97
SALE PRICE
ex vat inc vat
£85.11 £100.00

Part No. UAM1662

MONTEGO
CYLINDER HEAD GASKET SETS
2.0 CARB



RRP ex vat £44.18
SALE PRICE
ex vat inc vat
£12.77 £15.00

Part No. LVQ701162EVA

MONTEGO
CYLINDER HEAD GASKET SETS
2.0 TURBO



RRP ex vat £81.11
SALE PRICE
ex vat inc vat
£59.95 £70.44

Part No. LVQ701177EVA

MONTEGO
WHEEL CENTRE TRIMS
HL & MAYFAIR
1988 ON
SILVER



RRP ex vat £15.86
SALE PRICE
ex vat inc vat
£6.38 £7.50

Part No. NAM7909MV

MONTEGO
WHEEL CENTRE TRIMS
1.6 BASE
NOV 1988 ON
SILVER



RRP ex vat £18.33
SALE PRICE
ex vat inc vat
£6.38 £7.50

Part No. NAM9107MNE

MONTEGO
WHEEL CENTRE TRIMS
VIN 607035 ON
DIAMOND
WHITE



RRP ex vat £16.27
SALE PRICE
ex vat inc vat
£6.38 £7.50

Part No. NAM9107NMN

MONTEGO
WHEEL CENTRE TRIMS
VIN 464731
TO 568001
SILVER



RRP ex vat £21.27
SALE PRICE
ex vat inc vat
£6.38 £7.50

Part No. NAM9593MNE



NEW PRODUCTS

REAR LIGHT UNITS



Description	Part No.	Price £ ex vat	Price £ inc vat.
MG ZR Rear Light Units (pair);			
Techno Chrome	XPT000094ACAP TECCHRM	139.56	163.98
Techno Black	XPT000094ACAP TECHBLK	139.56	163.98

Alternative style rear light units to personalise your car!



'Lexus' Style Rear Light Assemblies.

Description	Part No.	Price £ ex vat	Price £ inc vat.
MGF/TF 'Lexus' Style Rear Light Assemblies;			
Black background (pair)	XPT000152ACBP	85.11	100.0

FROM £100.00
(£85.11 ex vat)

NEW MINI LIGHT UNITS



Description	Part No.	Price £ ex vat	Price £ inc. vat
Headlamp Assembly (RHD) All models upto 2004			
LH	MLHL1112ARHD	138.76	163.04
Rear Lamp Unit (RHD) All models upto 2004			
LH	MLRL1902U	46.90	55.11
Side Lamp Assembly (RHD) All models upto 2004 Yellow Lens with bulb & carrier.			
LH & RH	MLSC1403AY	7.20	8.46

SEAT COVERS



ROVER 75/ZT REAR SALOON SEAT COVER

ROVER 25/ZR/45/ZS
FRONT SEAT COVER (EACH)

Description	Part No.	Price £ ex vat	Price £ inc vat.
Seat Covers;			
Rover 25/ZR/45/ZS Front (each)	VUK10001	15.05	17.68
Rover 75/ZT Rear - Saloon	VUK105080	21.28	25.00

FROM £17.68
(£15.05 ex vat)

DOOR WIND DEFLECTOR



FROM £17.14
(£14.59 ex vat)

Description	Part No.	Price £ ex vat	Price £ inc. vat
Door Wind Deflector (front pair);			
ZR/25 3dr	VUB104660	30.86	36.26
ZR/25 5dr	VUB104670	41.39	48.63
ZS/45	VUB104650	31.67	37.21
ZT/75 4dr	VUB111870	14.59	17.14



NEW PRODUCTS

MGF/MGTF HARD TOP

A Heritage Hardtop that fits both the MGF and the MGTF.

A classically styled Heritage hardtop evoking images from the great days of MG's. Sleek stylish and secure it makes the MGF/TF equally at home for high speed continental touring or daily commuting. Crafted and designed with the approval of the vehicle's designer and uniquely incorporating the bonnet and boot lid feature lines with an MG Octagon on the B post extension. The exterior comes in black gel coat ready to paint to your individual requirements. The interior is finished with an Alcantara headlining and has a heated glass rear window as standard. Installation and removal are simple operations as the hardtop is fixed to the standard factory fitted latch points.



£1050.00
(£893.62 ex vat)



HARD TOP COVER
VUK100030PMA

Description	Part No.	Price £ ex vat	Price £ inc. vat
MGF/MGTF Hard Top			
	HMP118099AMB	893.62	1050.00
Hard Top Cover			
	VUK100030PMA	72.27	84.92
Hard Top Wall Hanger Brackets			
	VUB101340	23.69	27.84

GENUINE SERVICE REPLACEMENT PETROL ENGINES

The demise of MG Rover in April 2005 led to the residual values of MGR vehicles taking quite a knock. It is good to see that the market for MGR used vehicles has recovered from this initial shock now that people realise that parts are still readily available. This commitment is clearly shown by the Service Replacement Engine Program that Xpart have announced. This offers extremely high quality units at very competitive prices, made even better value for money by the Rimmer discount. All units are fully factory tested after remanufacture with only 100% genuine parts being used. All units carry a full 12 months warranty. An old core surcharge has also been set a low level. This is refunded on receipt of a reconditionable engine. Also, see our website for any clearance bargains!



**CHECK FOR
LATEST
AVAILABILITY**

CHECK FOR LATEST AVAILABILITY

**Engines available range
from the 1.1 to the 2.5 V6**

Ring us to discuss your requirements and confirm price and availability.

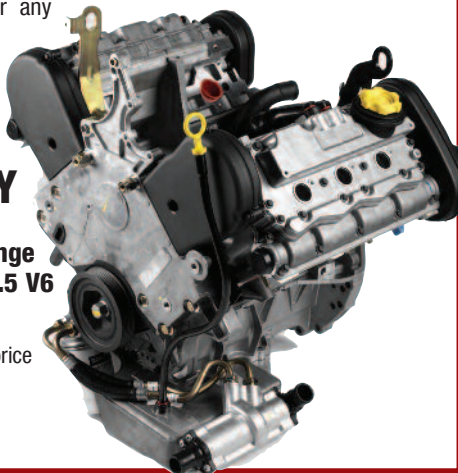

MGF/TF CAR COVER



FROM
£74.00
(£62.98 ex vat)

**AFTERMARKET CAR
COVER**
VUS100070PCREAM

Description	Part No.	Price £ ex vat	Price £ inc. vat
MGF/TF Car Cover;			
Aftermarket version (no logo)			
Indoor use - Cotton (Cream)	VUS100070PCREAM	62.98	74.00
Dry clean only.			
Outdoor use - Waterproof	RP1045	103.79	121.95
Not shown.			

HEADLAMP COVERS



FROM
£27.39
(£23.31 ex vat)

Description	Part No.	Price £ ex vat	Price £ inc. vat
Headlamp covers (pair);			
ZR/25	XBV100780	23.31	27.39
ZS/45	XBV100810	29.81	35.03
MGF	XBV100380	42.27	49.67
MGTF	XBV000160	31.77	37.33



NEW PRODUCTS

MGF/TF SPORTS EXHAUSTS



MGF & MGTF SPORTS SILENCER
XPT000039ACBP



LINK PIPE
RP1055



DE-CAT PIPE
RP1058



TUBULAR MANIFOLD
RP1054



SPORTS CATALYST
RP1056/7

Improve the performance of your MGF/TF with a Performance Exhaust.

Description	Part No.	Price £ ex vat	Price £ inc. vat
Sports Exhaust Silencer;			
MGF & MGTF	XPT000039ACBP	245.00	287.88
for early MGF (to Vin 522573)			
Elbow Joint	XPT000039ACA	50.21	59.00
Gasket	WCM100480	1.47	1.73
Manifold (Tubular) 4 into 2 into 1 (Stainless Steel).	RP1054	476.59	559.99
Link Pipe Manifold to cat.	RP1055	91.90	107.98
Sports Catalyst;			
to Feb 2002 (MGF)	RP1056	212.76	249.99
Feb 2002 on (MGTF)	RP1057	212.76	249.99
De-Cat Pipe Straight through pipe.	RP1058	69.79	82.00

MGF/TF COOLANT PIPES

Manufactured in stainless steel to avoid corrosion, these run underside front to rear of the vehicle.
Suitable for MGF & TF models (manual).
Not suitable for automatics.

£69.95
(£59.53 ex vat)

Description	Part No.	Price £ ex vat	Price £ inc. vat
Coolant Pipes	PEP102470SS	59.53	69.95
Antifreeze/Coolant	XP1LL	3.97	4.66
Special MG Rover specified "OAT" coolant. 1 Litre.			

CLASSIC MINI BUMPERS & BONNET MOULDING



New, improved, Stainless Steel Classic Mini Bumpers and Grille Mouldings.

The Grille Moulding is made from stainless steel using MG Rover original tooling, while the Stainless Steel Bumpers are manufactured using modern production methods and new tooling for an enhanced finish.

Description	Part No.	Price £ ex vat	Price £ inc. vat
Classic Mini Bumper (front & rear)	DPB10166SLP	60.36	70.92
Classic Mini Bonnet Moulding	ALA6559MMM	16.83	19.78

DIS-CAR-NECT

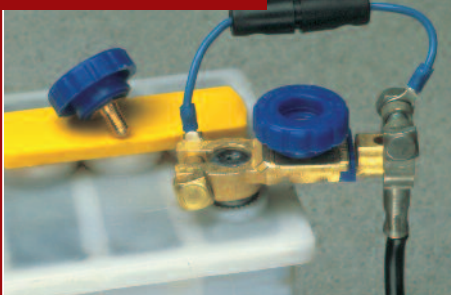

HOW DOES 'DIS-CAR-NECT' WORK ?

When leaving your car, simply remove the knob to isolate the starter circuit. The 16 amp by-pass fuse will maintain current to all other electrical circuits (central locking, stereo memories, alarm etc). Because the starter motor draws over 150 amp's, any attempt to connect (hot wire) the starter motor will instantly cause the fuse to blow. This immobilises the car until the knob is replaced. If this should happen, simply replace the 16 amp fuse at a convenient time.

As an added advantage, the 'Dis-Car-Nect' will also prevent battery drain if you intend to store your car, simply unscrew the knob and remove the fuse. For extra security, unscrew and remove the immobiliser knob completely.

Fits all vehicles and is easily fitted to any battery terminal.

Full installation instructions supplied with every unit.

Description	Part No.	Price £ ex vat	Price £ inc. vat
'Dis-Car-Nect' Starter Immobiliser Replacement;	RX1356	9.79	11.50
Screw Knob	RX1356K	2.81	3.30
Fuse	RX1356F	2.21	2.60



NEW PRODUCTS

MGF/TF POLY BUSH KIT



Improve the handling of your MGF/TF. They last longer too.

FROM
£37.00
(£31.49 ex vat)

Description	Part No.	Price £ ex vat	Price £ inc. vat
MGF Poly Bush Kit;			
Front	RP1046	31.49	37.00
Rear	RP1047	83.40	98.00
Front & Rear	RP1048	106.71	125.38
MGTF Poly Bush Kit;			
Front	RP1046TF	57.83	67.95
Rear	RP1047TF	165.96	195.00
Front & Rear	RP1048TF	212.77	250.00

MGF & TF MOULDED CARPET SETS



Offering superb fit, these 3 piece moulded carpet sets look great. Available in red, black, green, grey, blue & biscuit.

FROM
£160.00
(£136.17 ex vat)



Description	Part No.	Price £ ex vat	Price £ inc. vat.
Moulded Carpet Set; MGF '95 - '02			
RHD	RP1107	136.17	160.00
LHD	RP1108	136.17	160.00
Sound Insulation Kit (MGF RHD & LHD)	RP1109	44.25	51.99
MG TF '03 on (Includes sound insulation kit)			
RHD	RP1110	142.13	167.00

MGF & MGTF WIND DEFLECTOR

FROM
£180.00
(£153.19 ex vat)

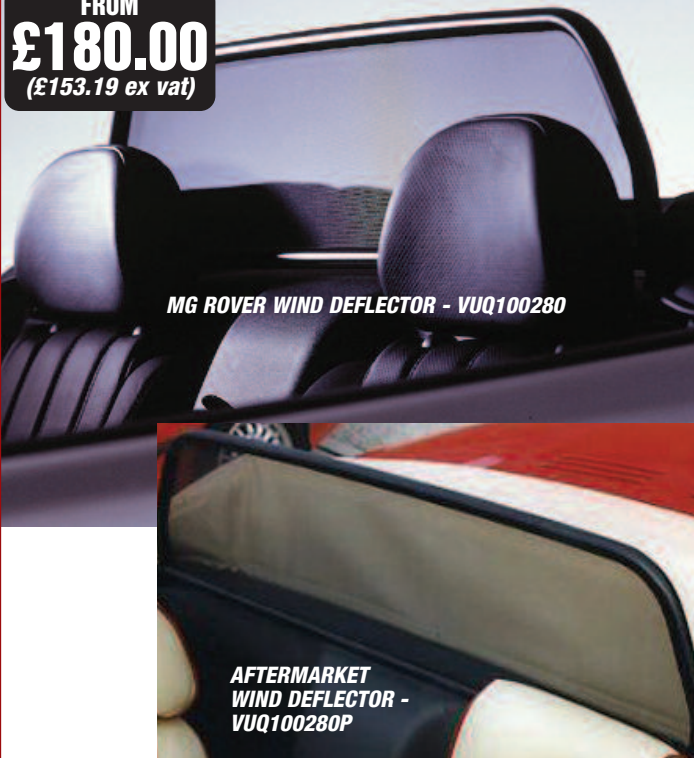

MG ROVER WIND DEFLECTOR - VUQ100280

AFTERMARKET WIND DEFLECTOR - VUQ100280P

WIND DEFLECTOR

Fitted snugly behind the seats, a wind deflector effectively reduces buffeting when the hood is down. Easy to fit and remove. Not compatible with Roll Hoops.

Description	Part No.	Price £ ex vat	Price £ inc. vat.
MG Rover Wind Deflector (OE Spec)	VUQ100280	176.33	207.19
Note: Requires drilling to install.			
Aftermarket Wind Deflector	VUQ100280P	153.19	180.00
Note: No drilling required to install. Black leather covered frame.			

FABRIC CAR MAT SET



FROM
£39.29
(£32.34 ex vat)

SEE ALSO MATS LISTED IN CLEARANCE BARGAINS!

Description	Part No.	Price £ ex vat	Price £ inc. vat.
Fabric Car Mat Set (grey or black options - check for availability);			
ZR RHD/LHD	EAH000760PPA	33.44	39.29
ZS RHD	EAH000820PPA	37.83	44.45
ZT RHD	EAH000180LNF	48.49	56.98
ZT LHD	EAH000190LNF	42.28	49.68
MGF/TF RHD	EAH103900PMA	37.91	44.54
MGF/TF LHD	EAH103890PMA	38.52	45.26



NEW PRODUCTS

MGF & MGTF SPAX, GAZ & KONI SHOCK ABSORBERS

A range of performance shock absorbers are available for your MGF/TF.



Description	Part No.	Price £ ex vat	Price £ inc. vat
MGF Spax, Gaz & Koni Shock Absorbers;			
Front & Rear Kit	RP1171	Refer to price listings	
Front (pair)	RP1023	Refer to price listings	
Rear (pair)	RP1023	Refer to price listings	
MGTF Spax Shock Absorbers			
Front & Rear Kit	RP1172	406.85	478.05
Front (pair)	RP1024	154.89	182.00
Rear (pair)	RP1025	154.89	182.00

PRICES FROM
£182.00
(£154.89 ex vat)

MG, MINI & MAESTRO SPAX SHOCK ABSORBERS



PRICES FROM
£88.98
(£75.73 ex vat)

Description	Part No.	Price £ ex vat	Price £ inc. vat
SPAX Shock Absorbers (pair);			
MGB (Front)			
Conversion Kit	CK12	238.26	279.96
MGA/MGB/MGC (Rear)			
Conversion Kit	CK22	127.62	149.95
Sprite/Midget (Rear) Conversion Kit			
1959-64 models	CK5	184.64	216.95
1964-75 models	CK6	184.64	216.95
1975 on models	CK7	184.64	216.95
MG Midget (ZA/ZB)			
Front	RP1128	118.30	139.00
Rear	RP1129	118.30	139.00
MG Maestro (Adjustable Spring Seat)			
Front	RND072530EVA SPAX AS	208.51	245.00
Rear	NAM3959EVA SPAX AS	167.66	197.00
Mini (Available as standard or lowered ride height)			
Front	RBB071541EVA SPAX	75.73	88.98
Rear	RPD071542EVA SPAX	75.73	88.98
'Paddy Hopkirk' Special Edition set of 4	RP1157	213.62	251.00

MGTF / MGZR / MG ZS SPRING/SHOCK ABSORBER UNIT KITS

Available as a car set of 4, these units are complete with ride height adjustable springs to improve handling.



Description	Part No.	Price £ ex vat	Price £ inc. vat
Gaz Coil Over Shock Absorber Kit;			
MG ZR	RP1101	468.08	549.99
MG ZS	RP1102	468.08	549.99
Spax Coil Over Shock Absorber Kit;			
MG ZS (exc. V6)	RP1130	544.68	640.00
MG TF Spax & Eibach Spring Kit	RP1174	421.27	494.99
Eibach Uprated Spring Kit;			
MG TF	RP1173	161.70	190.00
Bilstein Comfort Handling Pack;			
MG TF	RP1175	570.21	670.00

FROM
£494.99
(£421.27 ex vat)

SERVICE KITS

PRICES FROM
£26.44
(£22.50 ex vat)



Description	Part No.	Price £ ex vat	Price £ inc. vat
K Series Engine - Service Kits;			
Rover 25/MG ZR	RP1009	32.50	38.19
Rover 45/MG ZS	RP1010	32.50	38.19
Rover 75/MG ZT	RP1011	26.25	30.84
MGF (to Vin 522572)	RP1013	43.83	51.50
MGF (from Vin 522572)	RP1014	43.83	51.50
V6 Engine - Service Kits;			
Rover 45/MG ZS	RP1059	48.36	56.82
Rover 75/MG ZT	RP1060	41.15	48.35
Diesel Engine - Service Kits;			
Rover 25/MG ZR	RP1118	22.50	26.44
Exc MG ZR160.			
Rover 45/MG ZS	RP1118	22.50	26.44
Rover 75/MG ZT			
exc. Pollen Filter	RP1065	41.15	48.35
inc. Pollen Filter	RP1064	54.79	64.38

FUEL PRESSURE REGULATOR



£105.00
(£89.36 ex vat)

This adjustable power boost valve gives instant throttle response, the removal of flat spots, better acceleration and extra engine performance.

Fits: Mini 1.3MPi - MGF 1.8i/VVC - ZR 1.4i/160/1.8 VVC - 214si - 218i 1.8 16v VVC 25 1.4/1.6/Streetwise - 414si - 416si - 418sl / 620Ti. For other applications please enquire.

Description	Part No.	Price £ ex vat	Price £ inc. vat
Fuel Pressure Regulator	RP1031	89.36	105.00



NEW PRODUCTS

ROVER 75/MG ZT/T POWER BOX2



**FOR IMPROVED ECONOMY
& PERFORMANCE**

**PLUG IN A
Power Box!**



- **More power & torque**
 - **No loss of economy**
 - **Easy installation**
- Significant power & torque increases are achieved by simply plugging in a Power Box.**

Power Boxes also available for other makes of diesel vehicle, including: ALFA AUDI BMW CHRYSLER CITROEN FIAT FORD HONDA HYUNDAI IVECO JEEP KIA LANCIA MAZDA MERCEDES MG MITSUBISHI NISSAN OPEL PEUGEOT RENAULT ROVER SAAB SEAT SKODA SUZUKI TOYOTA VOLVO VW

DIESEL PLUG-IN POWER UPGRADE

FOR ROVER 75 & MG ZT/T DIESEL

Installation is relatively easy, with no specialist tools or skills required.

No irreversible modifications are made - the Power Box can be removed just as easily and the vehicle reverts to its original state.

HOW DOES IT WORK?

Power Box is a high quality, *digital* management upgrade, incorporating a modern RISC microprocessor. The "chip" is carefully programmed - using the manufacturers standard fuel map as a foundation - and modifies the opening times of the injectors, which then accurately meters the extra fuel required. Unlike many *analogue* devices, which crudely over-fuel throughout the entire rev-range, each Power Box is specifically mapped for the intended application. Extra fuel is provided when needed - eliminating flat-spots and hesitation - but there is no unnecessary enrichment, meaning no loss of fuel economy and no *black smoke*. In fact, most Power Box users report a noticeable improvement in fuel economy, as they discover it's no longer necessary to work their vehicle so hard.

WHERE IS IT FITTED?

On most vehicles, the Power Box fits under the bonnet, interrupting the wiring loom from the engine ECU. All Power Boxes are fitted with the original vehicle connectors, so installation is simply a case of unplugging the relevant connector and plugging in the Power Box. Full instructions are supplied and no special tools or skills are required.

Power Boxes are small, neat and discrete. They are fully encapsulated in resin and are shock resistant. Care, of course, should be taken to locate the Power Box away from the effects of water.

HOW MUCH POWER WILL I GAIN?

On average, Power Boxes give around 20% increase in power and 15-20% increase in torque. However, more important is how the vehicle *feels*: throttle response, crispness and driveability are all immeasurably improved, while flat-spots and sluggishness are virtually eliminated.

ADDITIONAL POWER GAINS

We also strongly recommend fitting a K&N air filter with a Power Box. This will allow the engine to breathe and perform more efficiently (K&N's can also be cleaned and re-used). Please see page 49.

WHY NOT JUST HAVE MY ECU RE-CHIPPED?

Unlike an ECU chip, a Power Box can be fitted and removed easily. Also, as the Power Box doesn't disturb the ECU, its presence cannot be detected by diagnostic equipment. Finally, when the vehicle is sold, the Power Box can simply be removed if required and refitted to another vehicle.

In addition, Power Boxes are:

- ✓ TUV approved.
- ✓ Fully compliant with original exhaust emissions standards.
- ✓ Non-damaging to your engine.
- ✓ Power Box is covered by a 3 year guarantee (limited liability).

£350.00
(£297.87 ex vat)

Description	Part No.	Price £ ex vat	Price £ inc. vat
PowerBox;			
Rover 75 - 2 litre CDTi (130BHP)			
& MGZT/MGZTT	RP1114	297.87	350.00
Rover 75 - 2 litre CDT (116BHP)			
	RP1115	297.87	350.00

MGF GRILLE TRIMS

Personalise your MGF!

Description	Part No.	Price £ ex vat	Price £ inc. vat
-------------	----------	-------------------	---------------------

Front Grille Mesh - Stainless Steel (Front Bumper);
Woven Pattern **RP1119W** **59.53** **69.95**

Side Intake Duct Grille Mesh (Pair);
Note: Mesh only. See below also, for side Air Duct Assys.
Diamond Pattern **RP1122D** **16.60** **19.51**
Woven Pattern **RP1122W** **16.60** **19.51**

Buy a Car Set & Save!

Front & Side Intake Duct Grille Mesh Kit;
Includes items listed above.
Woven Pattern **RP1125** **67.06** **78.80**

Side Intake Duct Grille assembly (Pair);
Complete with fitted mesh.
Diamond Pattern **RP1120** **29.79** **35.00**
Available in Nightfire Red, Solar Red, Flame Red,
Volcano, Anthracite, Silver & White.
Woven Pattern **RP1121** **29.79** **35.00**
Available in British Racing Green 3.

WOVEN PATTERN
FRONT & SIDE
INTAKE DUCT GRILLE
MESH KIT - RP1125

FROM
£19.51
(£16.60 ex vat)



**DIAMOND PATTERN
SIDE INTAKE DUCT GRILLE
ASSEMBLY - RP1120**



NEW PRODUCTS

ACCESSORISE YOUR MG!

HANDBRAKE GRIP
RP1179 SILVER



HANDBRAKE GRIP
RP1179B



SILL TREAD PLATE
EAP100790MMM



SILL TREAD PLATE
RP1135 MG



GEAR LEVER SURROUND
RP1094



TAX DISC HOLDER
RP1097



GEAR KNOB
RP1100



PEDAL SET
RP1095

FROM
£5.95
(£5.06 ex vat)



AERIAL
RP1096

Description	Part No.	Price £ ex vat	Price £ inc. vat
Gear Knob - MG logo Universal fit.	RP1100	25.49	29.95
Gear Lever Surround MG ZR ('96 on)/Rover 200/Metro A & K series.	RP1094	21.49	25.25
Handbrake Grip - Alloy Available in black, silver & titanium.	RP1179	29.75	34.96
Handbrake Grip Leather/Chrome.	RP1179B	31.06	36.50
Sill Tread Plate MG Logo (each);			
MGF & TF	EAP100790MMM	9.75	11.46
MGB, GT, C & V8	RP1135	5.92	6.96
Midget & Sprite	RP1187	5.06	5.95
Aerial Universal fit. With adaptors and anti-theft fitment. Available in black, silver, red & blue.	RP1096	16.94	19.90
Pedal Set Universal fit. brake, clutch & accelerator.	RP1095	25.49	29.95
Tax Disc Holder - MG logo Available in black or silver.	RP1097	16.94	19.90

K&N INDUCTION KITS

MG F 1.8 (inc VVC)
RP1026

FROM
£81.50
(£69.36 ex vat)



Description	Part No.	Price £ ex vat	Price £ inc. vat
K&N Inducton Kits;			
MG F 1.8 (inc VVC) 57i (STD).	RP1026	74.00	86.95
MG TF 1.8 (135 & 160bhp) 57i (STD).	RP1027	85.06	99.95
MGZR 1.4i/1.8/ZS 1.8 57i (STD).	RP1062	96.98	113.95
MGZR 1.4i 57i GEN.2 (UPRATED).	RP1063	144.64	169.55
ROVER 25 57i (STD).	RP1062	96.98	113.95
MGZR VVC (180BHP) 57i GEN.2 (UPRATED).	RP1085	140.00	164.50
ROVER 25/MGZR 2.0 TD 57i (STD).	RP1086	69.36	81.50
MGZS 2.5 V6 57i GEN.2 (UPRATED).	RP1088	144.64	169.95
ROVER 75/MGZT 2.5 V6 57i GEN.2 (UPRATED).	RP1089	144.64	169.95

KEY FOBS

FROM
£4.50
(£3.83 ex vat)



Description	Part No.	Price £ ex vat	Price £ inc. vat
Rover Key Fob	R01067	4.85	5.70
MG Key Fob;			
Brown/Cream	RP1049	4.08	4.79
Black/White	RP1051	4.08	4.79
Red/Cream	RP1052	4.08	4.79
V8 Key Fob	RX1537	4.08	4.79
Union Jack Fob	RX1545	3.83	4.50
Rover Key Fob	RP1158	4.08	4.79
MG Key Fob	RP1159	7.23	8.50



NEW PRODUCTS

ROVER 45 & 75 TIMING BELT KIT



Description	Part No.	Price £ ex vat	Price £ inc. vat
Timing Belt Kit - Rover 45, 75, MG ZS & ZT Includes 3 belts, 1 idler & 1 tensioner. KV6 Engines	ZUA000610	214.68	252.25

BATTERY ISOLATOR SWITCH

£10.50
(£8.94 ex vat)

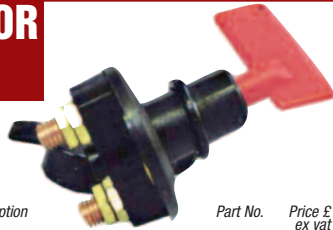

Description	Part No.	Price £ ex vat	Price £ inc. vat
Battery Isolator Switch	LL1171	5.96	7.00
Spare Key	LL1171KEY	2.30	2.70

K&N BREATHER FILTERS - GENERAL APPLICATIONS

Ideal for engines, transmissions etc etc.
Designed to either push on or clamp on as necessary.



CLAMP ON



PUSH ON

Description	Part No.	Price £ ex vat	Price £ inc. vat
K&N Breather Filter; 2" O/D x 1 1/2" I/D x 1 1/2" High.			
Clamp on	62-1330	14.08	16.54
Push on	62-1010	14.08	16.54

ROTOR ARM

Modelled on the original, dependable 1960's design, but made from modern materials on the latest machinery to very close tolerances. These RED ROTORS will not let you down. The integrally moulded brass inlay dispenses with the troublesome rivet used on most versions which is known to short circuit. The increased insulation properties of the body makes them suitable for use with high voltage coils & electronic ignition kits. The spring steel clip on the underside, in conjunction with a revised internal tolerance assures a really snug fit, even on old & slightly reduced diameter mountings.



Description	Part No.	Price £ ex vat	Price £ inc. vat
Rotor arm (as original in red)			
Lucas 25D4 distributors	GRA101RED	7.23	8.50
MGB to 1974, MG Midget, & AH Sprite 948/1098/1275cc.			
Lucas 25D6 distributors - MGC	GRA102RED	7.23	8.50
Lucas 45D4 distributors	GRA114RED	7.23	8.50
MGB 1974 on, MG Midget 1500cc.			

MGF/TF UPDATED BRAKE DISCS & PADS

EBC BRAKE DISCS

EBC turbo groove discs are handed (lh & rh) with curved grooves and dimples to offer superb stopping power when combined with 'Green Stuff' Kevlar pads.

EBC BRAKES

ROSSINI UPDATED BRAKE DISCS

Performance drilled and grooved. Improved stopping power, reduced brake fade. Unique signature for improved safety. Superb quality. Use EBC Brake Pads with these discs.

Rossini

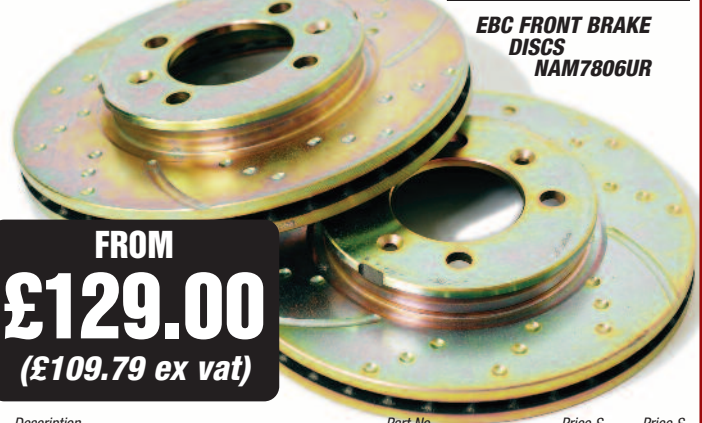

**EBC FRONT BRAKE DISCS
NAM7806UR**

FROM
£129.00
(£109.79 ex vat)

Description	Part No.	Price £ ex vat	Price £ inc. vat
-------------	----------	-------------------	---------------------

Updated Discs/Pads Kit;

EBC Turbo Groove Front Discs & Green Stuff Pads All models (exc TF160 & Trophy)	RP1019UR	139.05	163.38
TF160 & Trophy	RP1018UR	159.00	186.83

Brake Disc only - Updated;

Front (exc. Trophy & MGTf 160) EBC Turbo Groove (pair)	NAM7806UR	109.79	129.00
Rossini (pair)	NAM7806ROS	119.15	140.00
Front (Trophy & MGTf 160 only) EBC Turbo Groove (pair)	SDB000230UR	127.62	149.95
Rossini (pair)	SDB000230ROS	220.42	258.99
Rear (all models) EBC Turbo Groove (pair)	SDB100460UR	101.28	119.00
Rossini (pair)	SDB100460ROS	119.00	139.83



FROM
£48.95
(£41.66 ex vat)

**EBC 'GREEN STUFF'
BRAKE PADS
SFP000360GS**

Brake Pads only - Updated 'Green Stuff' EBC;

Front (exc. Trophy & MGTf 160)	SEM100020GS	41.66	48.95
Front (Trophy & MGTf 160)	SFP000310GS	41.66	48.95
Rear (all models)	SFP000360GS	42.55	50.00
Servo Support Mounting Strengthening Bracket Kit	RP1177	23.83	28.00



NEW PRODUCTS

LATE MGF & TF BRIGHT CENTRE CONSOLE SURROUND

Styled to compliment the bright cockpit features of your MGF TF



£100.80
(£85.79 ex vat)

Description	Part No.	Price £ ex vat	Price £ inc. vat
Late MGF & TF Bright Centre Console Surround	FHD102460MWK	85.79	100.80

PARCEL TRAY SHELF



£25.00
(£21.28 ex vat)

Description	Part No.	Price £ ex vat	Price £ inc. vat
Parcel Tray Shelf ZR/25 & ZS/45 (5 dr)	VTW100000	21.28	25.00

MGF CONSOLE & AIR VENT SURROUND



WALNUT EFFECT KIT
(09/99 on)
RP1093 WALNUT

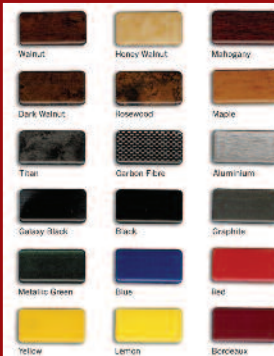

DASH KITS
COLOUR
OPTIONS
AVAILABLE
TO ORDER
ON KITS
RP1105,
RP1092 &
RP1093.

MG ZR / ROVER 25 CONSOLE SURROUND

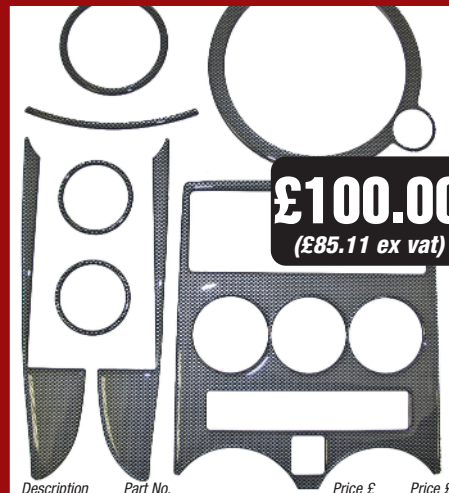

£100.00
(£85.11 ex vat)

Description	Part No.	Price £ ex vat	Price £ inc. vat
MG ZR / Rover 25 Console Surround Kit; Available in Alloy, walnut or carbon effect. August 2004 on. Extra colour options available to order.	RP1105	85.11	100.00

ALLOY EFFECT KIT
(03/96 - 08/99)
RP1092 ALLOY

CARBON EFFECT KIT
(09/99 ON)
RP1093 CARBON

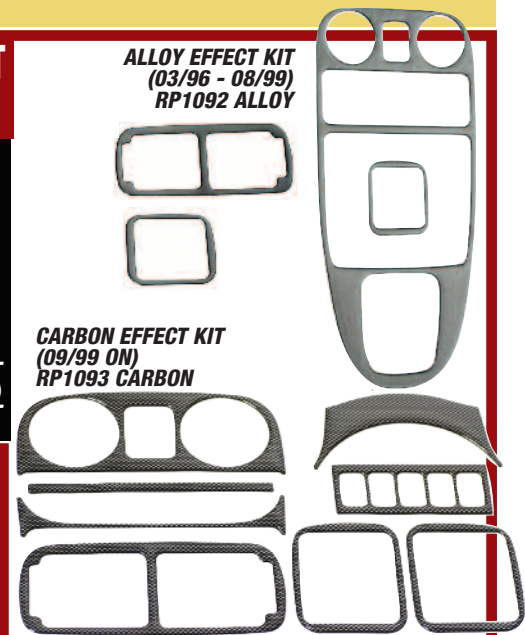

Description	Part No.	Price £ ex vat	Price £ inc. vat
MGF Console/Vent Surround Kit; See photos for contents. Available in Alloy, walnut or carbon effect. Extra colour options available to order.			
March '96 - Aug '99	RP1092	80.85	95.00
Sept '99 on	RP1093	57.87	68.00

FASTENERS - ASSORTMENT PACKS

Extremely useful assortment mix of 500 imperial fasteners.
Including either setscrews or bolts and also nuts, nyloc nuts & washers.



Description	Part No.	Price £ ex vat	Price £ inc. vat
Fasteners Assortment Pack with Setscrews	RX1560	19.56	22.96
Fasteners Assortment Pack with Bolts	RX1561	34.81	41.00

CHROME DOOR MIRROR BACKS



£33.93
(£28.88 ex vat)

ZR/25/ZS/45/ZT/75 (Late)



£80.78
(£68.75 ex vat)

Description	Part No.	Price £ ex vat	Price £ inc. vat
Chrome Door Mirror Backs (pair); ZR/25/ZS/45/ZT/75 (Late)	CRC100960MMM	28.88	33.93
Rover 75 (Early)	CRC100190MMM	68.75	80.78



NEW PRODUCTS

MGF/MGTF COMPLETE LEATHER SEATS



Available in 6 colours:
Porcelain green/dove grey, Dove grey/dark grey, British racing green, Black/white, Black/red piping, Red/Grey.

This late style MGF & TF seat lends itself to be a seat that you can choose very nearly any colour combination to suit you. We would suggest that you call us first to discuss your ideas, then we can agree a colour combination to match materials we can offer. Once we know your exact requirements, we will make up the seats and send them to you on an exchange basis.

Description	Part No.	Price £ ex vat	Price £ inc. vat
Leather 'Classic' Seats Complete Sold on exchange basis.	RP1149	638.30	750.00

MGF/MGTF DOOR PODS



If you are not happy with the dull cloth fitted in the centre of your door panels, we can offer you replacement parts so that the cloth is exchanged for high quality leather.

Instructions: To fit the leather door pods, you will need to remove the original Factory cloth inserts and press the new pods over the door casing. These items have been designed to be a tight fit but extra double sided adhesive will ensure they stay in place. Full instructions given.

Available in 6 colours: Black, British racing green, Cream, Light stone beige, Red, Tahiti Blue.

Description	Part No.	Price £ ex vat	Price £ inc. vat
Door Pods Leather Covered - pair	RP1151	91.90	107.98

MGF/MGTF OCTAGON LOCK RELEASE TRIM



They might only be small, but these beautifully crafted aluminium Octagons fitted on top of your door panel will cause a stir in the MG circles. Easy to fit and they look very classy.

Instructions: Simply insert the blade of a knife under the black original items and pull out of door casing. The new aluminium items should be a tight push fit in the hole. If slightly loose apply a small amount of adhesive under the Octagon.

Description	Part No.	Price £ ex vat	Price £ inc. vat
Octagon Lock Release Trim - Pair	RP1156	18.51	21.75

MGF/MGTF CENTRE CONSOLE LID & 'T' BAR



CENTRE CONSOLE LID

Most MGF's have the standard plastic "Cubby" box lids fitted. We can offer you Leather covered replacements on an exchange basis. They are sold as a matching set ready assembled (with contrasting top stitching if needed).

Instructions: All you need to do is undo four screws, fit and rescrew, takes about 5 minutes.

Available in 6 colours: Black, British racing green, Cream, Light stone beige, Red, Tahiti Blue.

'T' BAR

This 'T' bar, seen here behind the headrests, when fitted in conjunction with our centre console lids, will dramatically change the whole appearance of the interior of your MG. If they are covered in the same leather as your seats, you will have a complete matching set. This item is sold on an exchange basis.

Instructions: Basically held in place by three screws and plastic pull out clips. The seat belt bolt on the outside of each seat needs to be removed to allow the seat belt to pass through the holes in the T bar. Full pictorial instructions given.

Available in 6 colours: Black, British racing green, Cream, Light stone beige, Red, Tahiti Blue.

Description	Part No.	Price £ ex vat	Price £ inc. vat
Centre Console Lid, Upper & Lower Leather Covered	RP1154	160.00	188.00
'T' Bar Leather Covered	RP1155	157.45	185.00

MGF/MGTF DOOR POCKETS



These ingenious pockets are easily fitted. They come with a special Velcro backing which attaches to the carpet on the door casing and the corners are held firmly in place by self tapping screws and caps.

Available in 6 colours: Dove grey, Dark grey, Biscuit, British racing green, Cream, Red.

Description	Part No.	Price £ ex vat	Price £ inc. vat
Door Pockets -pair	RP1150	42.55	50.00

MGF/MGTF GEAR LEVER GAITER



All Mk.I cars had black vinyl gear lever gaiters-so perhaps you would like a different colour- we can help you. Easy to fit with our instructions

Available in 5 colours: Black, Dark grey, Biscuit, Cream, Red

Description	Part No.	Price £ ex vat	Price £ inc. vat
Gear Lever Gaiter & Grip Assembly, Leather	RP1152	22.98	27.00

MGF/MGTF HANDBRAKE GAITER & GRIP ASSEMBLY



Our leather handbrake grips are only available in black, but are supplied with a leather gaiter that can be made from a wide range of colours. When used in conjunction with the leather gear knob these items add that finishing touch to the centre console area.

Instructions: Not a difficult operation at all. The grip and gaiter are assembled as one unit and you need to just unclip the gaiter from the console and twist the grip off. Replacement is the reverse operation.

Available in 8 colours: Dove grey, Dark grey, Biscuit, British racing green, Cream, Light stone beige, Red, Ash Grey

Description	Part No.	Price £ ex vat	Price £ inc. vat
Handbrake Gaiter & Grip Assembly Leather	RP1153	59.56	69.98

MGF/MGTF HEATER CONTROL SET

Available in Polished or Anodised Silver Finish (shown).

Description	Part No.	Price £ ex vat	Price £ inc. vat
Heater Control Set;			
MGF	RP1160	41.28	48.50
MG TF	RP1161	41.28	48.50





NEW PRODUCTS

SEAT BELT KITS REPLACEMENT TYPE

Description	Part No.	Price £ ex vat	Price £ inc. vat
Inertia Reel Seat Belt Kit (each); MGB, MGA, MGC, RV8 & Midget	RB7355SA	37.87	44.50
MGF/TF, 200 (89 on), 400, 600	XKC2528	37.03	43.51
Mini, Metro, Maestro, Montego, 200 (84-89), 213, 216, 800, Magnette, 1100, 1300	XKC2528SA	37.03	43.51
Seat Belt Shoulder Pad (MG Logo); Pair	RX1414MG	17.45	20.50

Affordable, replacement, inertia type seat belt kits. 2 required per car. Supplied with reel, binnacle & fittings. Recommended to fit in pairs (Binnacles may differ to original).

**FROM
£43.51**
(£37.03 ex vat)



**SHOULDER PAD
RX1414MG**

**SEAT BELT
KIT
XKC2528**

MG & MINI COOPER BADGED VALVE CAPS SET



Description	Part No.	Price £ ex vat	Price £ inc. vat
MG Badged Valve Cap Set (4); Original	RRF100060	17.11	20.10
Aftermarket	RRF100060P	8.47	9.95
Anti-theft type	RRF100060PAT	11.02	12.95
Mini Cooper Badged Valve Cap Set (4); Original	RRF100040	14.63	17.19

**FROM
£9.95**
(£8.47 ex vat)

LED BULBS

LED bulbs are durable and vibration resistant, they have a longer life than standard bulbs. They give out an ultra bright light using just a fraction of the power of a standard bulb.



Description	Part No.	Price £ ex vat	Price £ inc. vat.
LED Bulbs (each); 12V 21/5W	GLB380LED	7.87	9.25
12V 21/5W RED	GLB380LEDRED	6.81	8.00
12V21W C/C	GLB382LED	7.87	9.25
12V21W C/C AMBER	GLB382LED AMBER	6.81	8.00
12V 5W LED	GLB501LED	4.42	5.19

MGTF FRONT FOG LAMPS

These foglamps emit a powerful beam of light to improve driving visibility in poor weather conditions. Designed specifically for the front bumper they also create a sporty look.



**FROM
£47.35**
(£40.30 ex vat)

Description	Part No.	Price £ ex vat	Price £ inc. vat.
MGTF Front Fog Lamps; Fog Lamp			
LH	XBJ105510	40.30	47.35
RH	XBJ105500	42.32	49.73
Switch	YUG102590PMP	15.61	18.34

SILVER INDICATOR BULBS

Suitable for clear lens conversions. Amber bulbs behind clear lenses create a "fried egg" effect. This can be remedied by fitting these new silver bulbs that shine amber only when lit. They are E-marked and road legal.



£16.00
(£13.62 ex vat)

Description	Part No.	Price £ ex vat	Price £ inc. vat.
Silver Indicator Bulbs (pair)			
Opposite Pin	GLB382 SILVER	6.81	8.00
Offset Pin	XZQ100190 SILVER	13.62	16.00
Side Repeater (capless)	XZQ100210 SILVER	13.62	16.00

DRIVING LAMPS



£46.95
(£39.96 ex vat)

Description	Part No.	Price £ ex vat	Price £ inc. vat.
Driving Lamps (pair); Chrome 5" dia.	RX1556	39.96	46.95
Stainless Steel 5" dia.	RX1556SS	46.77	54.95



NEW PRODUCTS

ROOF BARS



FROM
£105.41
(£89.71 ex vat)

Description	Part No.	Price £ ex vat	Price £ inc vat.
Roof Bars; ZR/25 3 door	CAB000060PMA	89.71	105.41
ZS/45	CAB000100PMA	94.45	110.98

SKI CLIPS

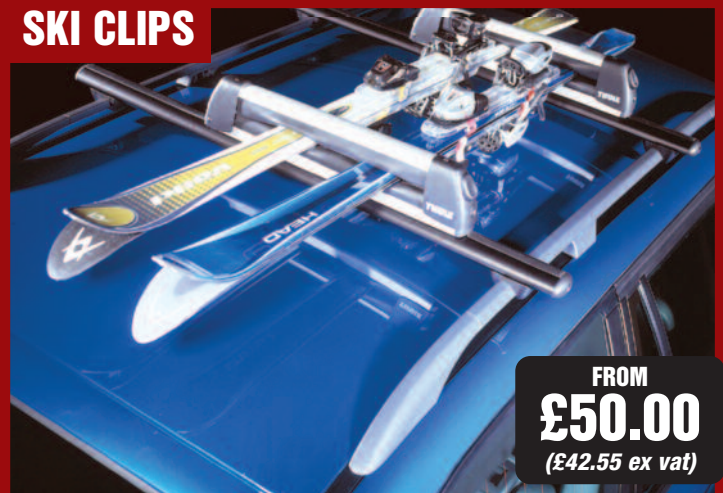

FROM
£50.00
(£42.55 ex vat)

Description	Part No.	Price £ ex vat	Price £ inc vat.
Ski Clips (pair of) for use with Roof Bars ZT/75	CAN100140	42.55	50.00

75 TOURER / ZTT ROOF RAILS



£58.93
(£50.15 ex vat)

Description	Part No.	Price £ ex vat	Price £ inc vat.
75 Tourer / ZTT Tourer Roof Rails;			
O/S Rail	CAC000020PMA	50.15	58.93
N/S Rail	CAC000030PMA	50.15	58.93
Brackets (6 req)	CAX100170	6.29	7.39
Bolt (6 req)	FT106257MA	2.95	3.47
Bolt (12 req)	CYG100410	2.04	2.40

DOG GUARD KITS



FROM
£79.61
(£67.75 ex vat)

**ROVER 25/ZR/200
DOG GUARD -
ESH100140**

**ROVER ZT-T
DOG GUARD -
ESH000010**

Description	Part No.	Price £ ex vat	Price £ inc vat.
Dog Guard Kits:			
25/ZR/200	ESH100140	67.75	79.61
ZT-T	ESH000010	85.85	100.87

TOWING MIRROR



£13.64
(£11.61 ex vat)

Description	Part No.	Price £ ex vat	Price £ inc vat.
Towing Mirror (each)	CRB108270	11.61	13.64

DETACHABLE TOWBAR

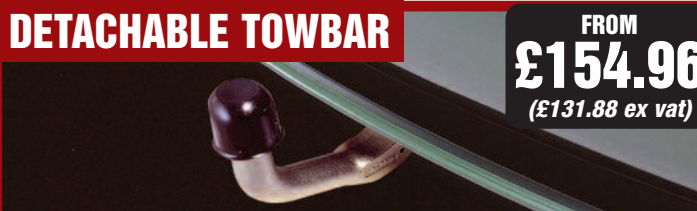

FROM
£154.96
(£131.88 ex vat)

Description	Part No.	Price £ ex vat	Price £ inc vat.
Detachable Towbar;			
ZR/25	KNB105710	212.50	249.69
ZS/45 4dr	KNB100690	203.75	239.41
ZS/45 5dr	KNB100670	131.88	154.96

Fixed towbars also available for Rover 25 & 45 - please enquire.

1:43 CORGI DIE CAST MODELS



EACH
£12.75
(£10.85 ex vat)

Description	Part No.	Price £ ex vat	Price £ inc vat.
1:43 Corgi Die Cast Models; MG ZT in Trophy Blue or Solar Red & Rover 75 in British Racing Green	RP1022	10.85	12.75



NEW PRODUCTS

MGF / TF STAINLESS STEEL WIRE WHEELS (BOLT ON)

Personalise your MGF/TF with a set of bolt on wire wheels in durable stainless steel. Rim size 7"x 16", 64 spoke (tubeless). Complete with nuts, cap and wrench.



For Trophy/TF160 models, please quote VIN no. to check application.

FROM
£340.00
(£289.36 ex vat)

Description	Part No.	Price £ ex vat	Price £ inc. vat
Wire Wheel - Bolt on (7" x 16")			
Each	RP1106	289.36	340.00
Set of 4	RP1106K	1079.00	1267.83

K SERIES HEAD GASKET SET

FROM
£57.50
(£48.94 ex vat)

An improved design to end head gasket problems! A multi-layer head gasket, strengthened, oil rail and special bolts.

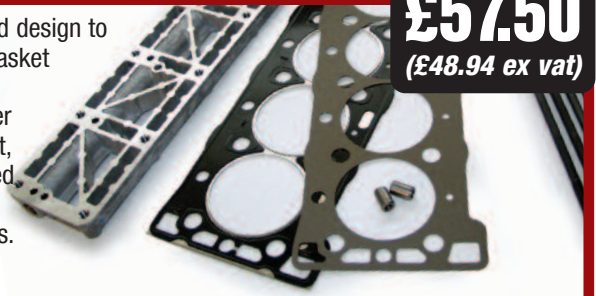

Description	Part No.	Price £ ex vat	Price £ inc. vat
Head Gasket/Oil Rail Kit <i>Inc. Full head gasket set & oil rail.</i>	ZUA000080	148.45	174.43
Head Gasket/Oil Rail Kit (Sail) <i>Inc. Full head gasket set & oil rail.</i>	ZUA000530	178.15	209.33
Head Gasket only	LVB500190	48.94	57.50
Oil Rail only	LCN000140L	41.70	49.00

TOUCH UP PAINTS

Touch Up Paints - Aerosols and Pencils.

Have your colour code ready when enquiring.



MAESTRO & MONTEGO ANTI ROLL BAR LINK



Description	Part No.	Price £ ex vat	Price £ inc. vat
Anti Roll Bar Link Polyurethane	NAM6857POLY	45.11	53.00

ELECTRIC FAN ASSY

We have a large volume of these units in stock at a special price. 11" diameter fan. Suitable for general applications. Wholesale terms available.



£14.69
(£12.50 ex vat)

Description	Part No.	Price £ ex vat	Price £ inc. vat
Electric Fan Assy	BAU4985	12.50	14.69

25/ZR MK1 & MK2 SIDE SKIRTS

Description	Part No.	Price £ ex vat	Price £ inc. vat
25/ZR Side Skirts;			
Mk1			
O/S Skirt	DDJ101081LML	109.50	128.66
N/S Skirt	DDJ101091LML	109.50	128.66
Clips (10 req) <i>Supplied with skirts.</i>	DDQ000050	2.62	3.08
O/S End Cap	DDJ000380	18.17	21.35
N/S End Cap	DDJ000390	18.17	21.35
Tape	DYN000040L	30.77	36.15
Mk2			
O/S Skirt	DDJ000720LML	73.79	86.70
N/S Skirt	DDJ000730LML	73.79	86.70
Clips (10 req) <i>Supplied with skirts.</i>	DDQ000050	2.62	3.08
O/S End Cap	DQM000160	25.20	29.61
N/S End Cap	DQM000170	25.20	29.61
Tape	DYN000040L	30.77	36.15

**25/ZR MK1
SIDE SKIRTS
O/S DDJ101081LML
N/S DDJ101091LML**



SKIRTS FROM
£86.70
(£73.79 ex vat)

ROVER 75 TYRE PROTECTOR KIT

FROM
£8.81
(£7.50 ex vat)



Description	Part No.	Price £ ex vat	Price £ inc. vat
Tyre Protector Kit - Front Rover 75	RSC000131	7.50	8.81



NEW PRODUCTS

BONNET PINS

£8.75
(£7.45 ex vat)



Description	Part No.	Price £ ex vat	Price £ inc. vat
Bonnet Pins (Pair); Silver	RX1555	7.45	8.75

UNLEADED FUEL ADDITIVES



FROM
£8.00
(£6.81 ex vat)

Bottled additives are available which can be mixed with either 'Premium' or 'Super' unleaded depending upon application. It usually works out cheaper to use bottled additives than leaded or LRP - work it out for yourself!

Description	Part No.	Price £ ex vat	Price £ inc. vat
Castrol Valvemaster; 250ml	RX1407VM	6.81	8.00
Plus (250ml)	RX1407VMP	9.56	11.23

Endorsed by the federation of British Historic Vehicle Clubs (FBHVC), having been independently tested and approved, both products offer a high level of protection against valve seat recession under all driving conditions. In addition, castrol valvemaster plus provides an octane boost to premium unleaded petrol which reduces pinking or knocking on high compression or performance applications. This also usually avoids the need to re-tune your engine. Treats 250 litres of petrol.

FIRE EXTINGUISHER



£11.55
(£9.83 ex vat)

Description	Part No.	Price £ ex vat	Price £ inc. vat
Fire Extinguisher	S3SSFE1	9.83	11.55

PARKING SENSOR KIT



£85.00
(£72.34 ex vat)

Universal type kit, includes 4 flush fit sensors, fitting kit, hole cutter, LCD - colour display unit & fitting instructions.

Description	Part No.	Price £ ex vat	Price £ inc. vat
Parking Sensor Kit	RX1559	72.34	85.00

HEATED WASHER JETS



Make frozen washer jets a thing of the past. As the ignition is switched on the washer jets are heated and defrosted for more immediate use.

FROM
£24.04
(£20.46 ex vat)

Description	Part No.	Price £ ex vat	Price £ inc. vat
Heated Washer Jets (pair); ZR/25/ZS/45/MGF/MGTF	VUB100220	71.21	83.67
ZT/75	VUB102110	20.46	24.04

RIMWAX

£15.50
(£13.19 ex vat)



RimWax - provides extreme shine and protection for all wheel finishes including chrome and alloy wheels.

Don't let dull, dirty rims ruin the look of your freshly washed and waxed car! RimWax is the answer. RimWax is a specialized cleaner, polish and wax that quickly restores a bright, polished and protected wheel finish. The anti-static RimWax formula actually helps repel brake dust to reduce dust buildup by as much as 75%.

The fine RimWax polish brightens all chrome, polished aluminum and factory clear coat finish wheels. The ultra-tough RimWax sealant protects wheels for months, preventing water spotting and staining from road contaminants and brake dust buildup.

Features

- Professional Wheel Polish and Sealer
- Removes bonded brake dust and oxidation
- Polishes clear coated, polished and chrome wheels
- Shines, protects and repels brake dust

Description	Part No.	Price £ ex vat	Price £ inc. vat
RimWax	RX1262	13.19	15.50

GB BADGE

FROM
£12.55
(£10.68 ex vat)



Description	Part No.	Price £ ex vat	Price £ inc. vat
-------------	----------	-------------------	---------------------

Stick on GB Badge;
Brushed Stainless Steel. Raised letters. Self Adhesive.
Original **DAM100690MMM** **27.95** **32.84**
Aftermarket **DAM100690MMP** **10.68** **12.55**

CAMSHAFT GEAR LOCKING TOOL

£23.40
(£27.50 ex vat)



Description	Part No.	Price £ ex vat	Price £ inc. vat
Camshaft Gear Locking Tool, K Series Engine	18G1570	23.40	27.50



NEW PRODUCTS

WORKSHOP MANUALS

FROM £32.74
(£27.86 ex vat)

A re-issue of the official factory manuals.

Description	Part No.	Price £ ex vat	Price £ inc. vat
Workshop Manual; MG F	RP1028	43.00	43.00
MG TF	RP1077	39.50	39.50
Rover 25 & MG ZR	RP10040E	45.00	45.00
Rover 75 & MG ZT	RP10120E	45.00	45.00
MG TF DVD	RP1077DVD	27.86	32.74

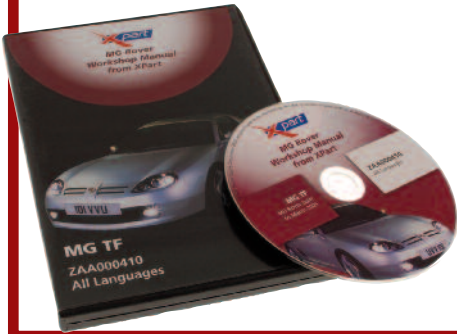

MGF & TF PERFORMANCE PORTFOLIO

£14.00
(no vat)

1995-2005
MGF 1.8i - Supermile
Rover 1.8i - Chantrel
1700 - Trophy 1600 1700
TF - 135 - 160

This 128 page Brooklands Books edition covers the range from 1995 to 2005 and is a must for all those owning or wanting a performance version of the marque.

Description	Part No.	Price £ ex vat	Price £ inc. vat
MGF & TF Performance Portfolio	RP1029	14.00	14.00

MG XPOWER SV

£27.50
(no vat)

The story of the SV by David Knowles. 176 pages and 290 pictures.

Description	Part No.	Price £ ex vat	Price £ inc. vat
MG XPower SV	RP1033	27.50	27.50

MGF HAYNES MODERN SPORTS CARS

£20.25
(no vat)

An interesting read for all those MG & MGF buffs. 144 pages.

Description	Part No.	Price £ ex vat	Price £ inc. vat
MGF Haynes Modern Sports Cars Reference Book	RP1030	20.25	20.25

Written by David Knowles.

COLLECTING AUSTIN-HEALEY, MG & TRIUMPH

£14.00
(no vat)

A gold mine of a book full of the pros and cons of sports car ownership, merits of particular makes and models and what to look for (and avoid) when buying a classic. 128 pages.

Description	Part No.	Price £ ex vat	Price £ inc. vat
Collecting Austin-Healey, MG & Triumph Book	RX1478	14.00	14.00

Written by Keith Martin.

MGF & TF ULTIMATE BUYERS' GUIDE

£11.25
(no vat)

An A5 64 page paperback packed with all the technical specifications, models, chassis, colours, options and year by year changes and tips on what to look for and what goes wrong.

Description	Part No.	Price £ ex vat	Price £ inc. vat
MGF & TF Ultimate Buyers' Guide By Philip Raby	RP1032	11.25	11.25

MG - THE LEGEND, DVD

£10.50
(£8.94 ex vat)

This British Motor Heritage licensed DVD is around 70 minutes long and covers the story of the MG marque, from early vintage models up to the 2003 model MG Z Saloons. There's a visit during the nineties to see MG RV8's being assembled on the Cowley line and a visit to Longbridge to see the modern MG Z range, including the ZR, ZS, ZT and TF's, rolling off the line.

Description	Part No.	Price £ ex vat	Price £ inc. vat
MG - The Legend, DVD	RP1113	8.94	10.50



NEW PRODUCTS

HAYNES WORKSHOP MANUALS

Haynes Workshop Manuals;

- New Mini (July 2001-2005)
- Mini (1959-1969)
- Mini (1969-2001)
- MGB (1962-1980)
- MG Midget & Austin Healy Sprite (1958-80)
- Rover 214 & 414 (1989-1996)
- Rover 216 & 416 (1989-1996)
- Rover 211, 214, 216, 218, 220 (1995-98)
- Rover 25 & MG ZR (1999-2004)
- Rover 414, 416 & 420 (1995-1998)
- Rover 618, 620 & 623 (1993-1997)
- Rover 820, 825 & 827 (1986-1995)
- Rover Metro, 111 & 114 (1990-1998)
- Rover 45 & MG ZS
- Rover 75 & MG ZT

- RBMW1002**
- RP1143**
- RP1041**
- RP1142**
- RP1141**
- RP1001**
- RP1002**
- RP1003**
- RP1004**
- RP1005**
- RP1006**
- RP1007**
- RP1008**
- RP1053**
- RP1012**
- RX1569**

Haynes Workshop Manual Protector



FROM
£19.99
EACH (no vat)



OWNERS HANDBOOKS

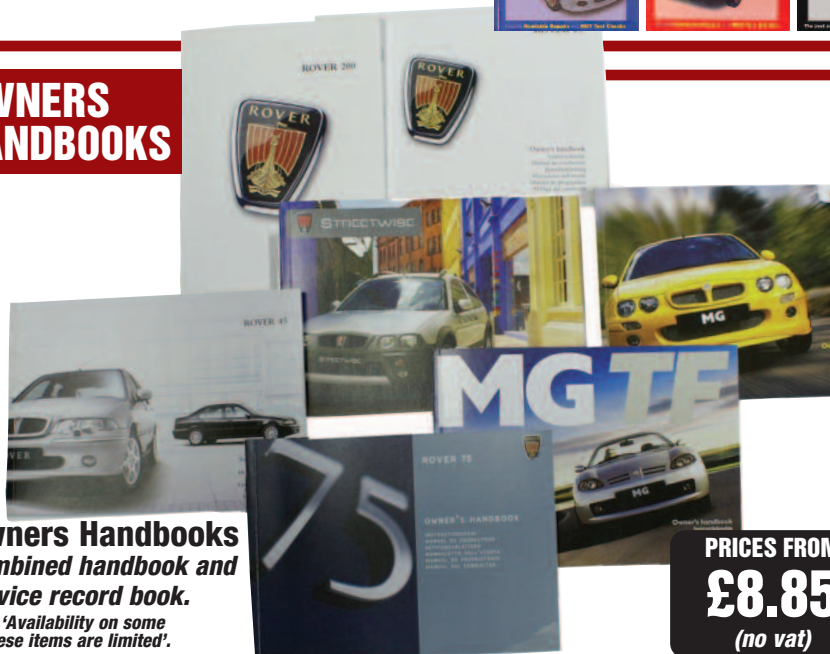

Owners Handbooks
Combined handbook and
service record book.

Note 'Availability on some of these items are limited'.

PRICES FROM
£8.85
(no vat)

- Rover 200
- 3/5dr 1995
- Coupe 1995
- 3/5dr 1998/1999 (to Vin 455992)

- RCL0003ENG**
- AKM7007ENG**
- RCL0245ENG**

- Rover 25
- 2001/2002 (to Vin 672953)
- 2002/2003 (to Vin 704355)
- 2003 (to Vin 732813)
- 2003 (to Vin 778996)
- 2004 on

- VDC000140EN**
- VDC000400EN**
- VDC000460EN**
- VDC000461EN**
- VDC000580EN**

- MG ZR
- 2001/2002 (to Vin 672953)
- 2002 (to Vin 683540)
- 2002/2003 (to Vin 704355)
- 2003 (to Vin 732813)
- 2003 (to Vin 778996)
- 2004 on

- VDC000150EN**
- VDC000370EN**
- VDC000430EN**
- VDC000470EN**
- VDC000471EN**
- VDC000590EN**

- Streetwise
- 2003 (to Vin 778996)
- 2004 on

- VDC000520EN**
- VDC000620EN**

- Rover 400
- 4/5dr 1996-7 (to Vin 259651)
- 4/5dr 1997 (to Vin 312616)
- Tourer 1998/1999 (to Vin 457575)

- RCL0199ENG**
- RCL0216ENG**
- RCL0256ENG**

- Rover 45
- 2001/2002 (to Vin 597440)
- 2002 (to Vin 602127)
- 2002 (to Vin 612917)
- 2003 (to Vin 637208)
- 2004 on

- VDC000180EN**
- VDC000380EN**
- VDC000410EN**
- VDC000500EN**
- VDC000600EN**

- MG ZS
- 2001/2002 (to Vin 597440)
- 2002 (to Vin 612917)
- 2003 (to Vin 637208)
- 2004 on

- VDC000170EN**
- VDC000440EN**
- VDC000510EN**
- VDC000610EN**
- VDC000530EN**

- City Rover 2003 on
- Rover 75
- 1999/2001 (to Vin 215157)
- 2001/2002 (to Vin 264830)
- 2002 (to Vin 270360)
- 2002/2003 (to Vin 279843)
- 2003 (to Vin 321637)
- 2004 on

- RCL0306ENG**
- VDC000180EN**
- VDC000350EN**
- VDC000420EN**
- VDC000480EN**
- VDC000560EN**

- MG ZT
- 2001/2002 (to Vin 264830)
- 2002/2003 (to Vin 279843)
- 2003 (to Vin 321637)
- 2004 on

- VDC000190EN**
- VDC000450EN**
- VDC000490EN**
- VDC000570EN**

- MG ZT260
- 2003 (to Vin 000214)
- MGF 1995/2002 (to Vin 600289)
- 3rd Edition
- 4th Edition

- VDC000540EN**
- RCL0332ENG**
- VDH101280ENG**

- MGTF
- 2002 (to Vin 620548)
- 2003 on

- VDC000320EN**
- VDC000321EN**

DVD'S

The Parts Catalogues, Workshop Manual and Drivers Handbook's you need - all on one DVD!



22.50
(inc vat)



DVD'S:
Special Tuning Data (1950-1976) **HMCC2006DVD**
Data Sheets, Paris Listings & Handbooks.

- Mini (1959-1969)
- Mini (1969-1985)
- Mini (1985-2000)
- MGB (1962-1969)
- MGB (1970-1974)
- MGB (1974-1980)
- MGB GT V8 & MG RV8
- Sprite/Midget (1957-1964)
- Sprite/Midget (1964-1974)
- Midget (1974-1979)

- HMCC4001DVD**
- HMCC4002DVD**
- HMCC4003DVD**
- HMCC3005DVD**
- HMCC3006DVD**
- HMCC3007DVD**
- HMCC3008DVD**
- HMCC1003DVD**
- HMCC3009DVD**
- HMCC3010DVD**

GENERAL ACCESSORIES

ELECTRICAL

FROM
£10.95
(£9.32 ex vat)



Description	Part No.	Price £ ex vat	Price £ inc. vat
Air Horns (Pair)	RX1381MARIO	21.91	25.74
Front Fog Light (Pair)	RX1370	20.64	24.25
Rear Fog Light	RB7092	9.32	10.95
Inspection Lamp (Halogen) (Plugs into cigar lighter)	RX1424	9.79	11.50
Trailer Board (4') (Including 4m of cable)	RX1513	15.75	18.51
Portable Halogen Worklight 240v (500w)	RX1263	15.96	18.75

BODY PAINTS

FROM
£2.98
(£2.54 ex vat)

Aerosols,
Touch-in Tins
& Touch-in Crayons



GENERAL USE AEROSOLS

Description	Part No.	Price £ ex vat	Price £ inc. vat
Black - Gloss (400ml)	RX4070A	8.51	10.00
Black - Matt (500ml)	RX1266	4.21	4.95
Black - Satin (500ml)	RX1538	5.95	6.99
Silver (Suitable for wheels) (450ml)	RX1265	7.23	8.50
Lacquer - Clear (Suitable for wheels) (400ml)	RX1261	2.54	2.98
Primer - White (150ml)	RX4048A	3.36	3.95
Primer - Red Oxide (150ml)	RX4049A	3.36	3.95
Primer - Grey (150ml)	RX4047A	3.36	3.95
Engine Black (High Heat)			
Aerosol Hy-cote (400ml)			
Black	RX1432A	5.92	6.96
Tin - Brush-on (125ml)	RX1432B	6.95	8.17
Chassis Paint (Black) (For general touch-up)			
Brush on (125ml)	RX4070B	5.75	6.76

BATTERY CONDITIONER

The battery charger that turns
on and off, automatically.

£44.94
(£38.25 ex vat)



Suitable for all 12 volt batteries (from 5AH to 100AH), this superb product constantly revitalises the battery cells - helping to extend cell life, without the danger of overcharging.

Comes complete with all fittings
& operating instructions.

Description	Part No.	Price £ ex vat	Price £ inc. vat
Battery Conditioner Kit	RX1410CTEK	38.25	44.94
Battery Charger 6v/12v Conventional type.	GAC7106	35.70	41.95

ROADSIDE TOOLS & TOURING EQUIPMENT

FROM
£5.95
(£5.06 ex vat)



Description	Part No.	Price £ ex vat	Price £ inc. vat
Lightweight (Disposable) overalls; Ideal for those roadside repairs. Keep these very handy lightweight general purpose overalls in the boot, you never know!			
L (approx 51" chest)	CONS5220	6.59	7.74
XL (approx 55" chest)	CONS5221	6.59	7.74
'AA' Membership & Relay Pack	RX1329	74.89	88.00
'Warning Triangle	RX1344	5.06	5.95

Description	Part No.	Price £ ex vat	Price £ inc. vat
Safety Jacket (luminous) Be safe - Be seen.	GAC2999	10.21	12.00
Tool Bag only (for jack etc)	RX1364	14.35	16.86
Scissor jack & handle	311346	21.86	25.69
Foot Pump	GAT347	22.13	26.00
'First-Aid' kit	RX1399	11.02	12.95
Fire Extinguisher	GAC9904X	19.53	22.95

GENERAL ACCESSORIES

£170.00
(£144.68 ex vat)



TURBO-GUARD

Ideal protection for all TD owners!

Turbo failure can often be attributed to oil starvation both at start-up and shut-down. Oil can 'carbonise' in a hot turbo after the engine is turned off and the turbo is still revolving, effectively allowing the turbo to run-on unlubricated! At start-up, the turbo will revolve momentarily on dry bearings until the oil pressure builds up from the engine.

Turbo-Guard stops this from happening. It is a reliable, automatic, maintenance free device that ensures pressurised oil is present at all times.

Comprising of an oil accumulator tank, oil feed hose and a one-way check valve, it can easily be installed by a competent person.

The kit is for universal application and will therefore fit a variety of applications.

Description	Part No.	Price £ ex vat	Price £ inc. vat
TURBO-GUARD	RX1547	144.68	170.00

£130.00
(£110.64 ex vat)



TURBO INSULATION KIT

Designed to reduce turbo lag and reduce under bonnet temperatures.

The Turbo Insulation Kit adds additional horse-power while protecting costly components from unwanted under-bonnet heat.

Designed to fit all turbo installations, the kit comes complete with all the materials for a clean, professional looking installation.

Description	Part No.	Price £ ex vat	Price £ inc. vat
TURBO INSTALLATION KIT	RX1546	110.64	130.00

£95.00
(£80.85 ex vat)



AIR INTAKE PIPE COVER

Reflects heat away from air intake and intercooler pipes!

This product is designed to reflect heat away from the air intake pipe allowing cooler air to be introduced into the engine intake for a denser air/fuel charge.

Ideal for most applications including intercooler pipes for added power and engine efficiency!

Made from heat treated fibreglass with a reflective coating, it is easily installed (without tools) with the full length hoop and loop closure system.

Size: 36" long x 14" wide.

Description	Part No.	Price £ ex vat	Price £ inc. vat
AIR INTAKE PIPE COVER	RX1548	80.85	95.00

COMPETITION TYPE HARNESS

A popular alternative to standard seat belts - these really do look the part!

The 4-point harness shown (no. 1) can be converted to the 6-point type by the inclusion of the crotch strap listed (no. 2). Note that fittings (eye bolts, reinforcement plates & bolts/spacer sets) are supplied separately. Harnesses are supplied singularly in 2" wide red webbing (black or blue webbing supplied to special order).

This harness is designed for road use - please contact us if you have specific FIA/RAC approved type requirements.

Description	Qty Req	Part No.	Price £ ex vat	Price £ inc. vat
1 HARNESS, competition type, red or black (each)	(2)	RX1500	77.49	91.05
2 CROTCH STRAP, red or black (each)	(2)	RX1501	18.72	22.00
3 SHOULDER PADS, (pair) 'Securon' available in red	(a/r)	RX1502	15.96	18.75
'MG Logo' black with red logo	(a/r)	RX1414MG	17.45	20.50
4 EYE BOLT SET (pair)	(2)	RX1503	8.30	9.75
5 REINFORCEMENT PLATE SET (pair)	(2)	621112	5.11	6.00
6 BOLT & SPACER SET (pair)	(2)	RX1505	5.32	6.25

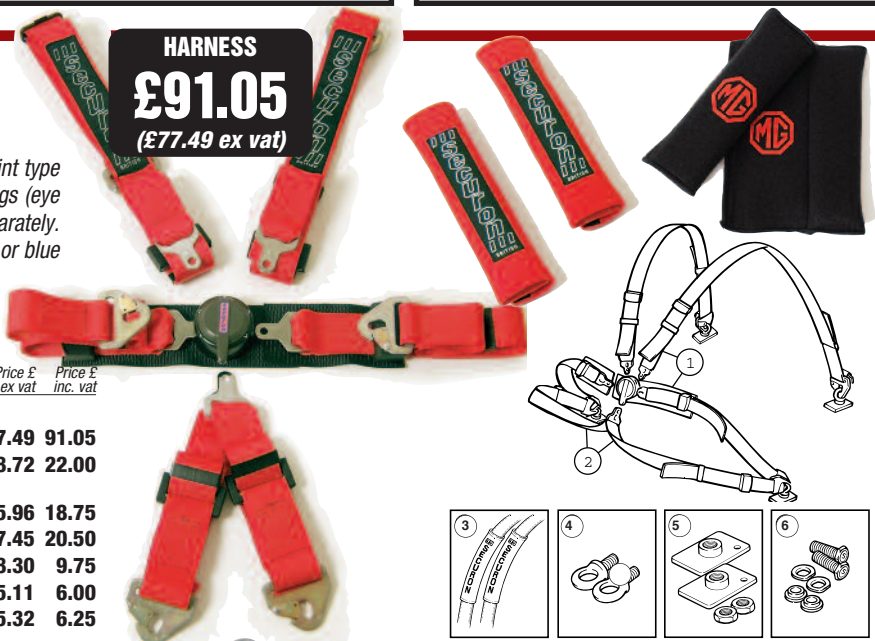

BOOT RACK

RX1330



FROM
£59.51
(£50.65 ex vat)

RX1330H-V



Description	Part No.	Price £ ex vat	Price £ inc. vat
-------------	----------	-------------------	---------------------

Specific Applications:-

MGB - Stainless Steel Mille Miglia (6 bar) (78x40x7cm)	RX1330H-V	89.36	105.00
MGF/TF - Stainless Steel Mille Miglia (7 bar) (89x40x7cm)	RP1123	103.83	122.00

Universal Applications:-

Aluminium frame/wood slats (inc Fittings)	RX1330	65.40	76.85
All Aluminium frame (inc Fittings)	RX1330A	50.65	59.51

OUR BOOT RACKS ARE EASY TO FIT & REMOVE AND WILL COME IN HANDY WHEN SHORT OF LUGGAGE SPACE.

VOUCHERS



Description	Part No.	Price £ ex vat	Price £ inc. vat
Rimmer Bros Vouchers;			
£5	RX1337	5.00	5.00
£10	RX1338	10.00	10.00
£20	RX1339	20.00	20.00
£50	RX1341	50.00	50.00

ORDER BY PHONE: 01522 568000 / ON LINE: www.rimmerbros.co.uk / E-MAIL: mgrover@rimmerbros.co.uk

GENERAL ACCESSORIES



£21.44
(£18.25 ex vat)

HI-TEMP SHRINK TUBES

These shrink tubes are already supplied with the HT lead kits listed on page 19. They can also be used for many other applications such as an enhanced appearance to any hose or wire, bundle wires as alternative to plastic ties or protecting electrical connections. Available in grey, black, red, blue and in 2 sizes, with a shrink ratio of 3 to 1. Easily installed with naked flame. 18mm size shrinks to 6mm and 12mm size shrinks to 4mm. Supplied in packs of 25.

Description	Part No.	Price £ ex vat	Price £ inc. vat
-------------	----------	-------------------	---------------------

HI-TEMP SHRINK TUBES Packs of 25.

18mm dia x 38mm long	RX1468	18.25	21.44
12mm dia x 38mm long	RX1469	18.25	21.44



FROM
£17.32
(£14.74 ex vat)

THERMAL HEAT SLEEVES

This high temperature sleeving will protect wiring, HT leads, hydraulic hoses and coolant hoses from radiant heat.

Two different designs are offered. The fixed tube type is designed to slide over wiring/hoses whereas the velcro type can be easily installed without having to disconnect anything. Easy to cut and shape to suit. Supplied in 3ft lengths.

Description	Part No.	Price £ ex vat	Price £ inc. vat
-------------	----------	-------------------	---------------------

FIXED TUBE SLEEVE

Supplied in diameters of 0.5", 0.75", 1", 1.25", 1.5" (all 3ft long)

RX1471 from 14.74 17.32

VELCRO SLEEVE

Supplied in 1 size - 0.5"-1.5" diameter (3ft long).

RX1472 39.41 46.31



RADIATOR RELIEF

COOLING SYSTEM ADDITIVE

Radiator relief allows your radiator to transfer heat more efficiently, reducing your engines operating temperature (which is obviously controlled by the thermostat) by up to 30°F. You therefore have 'a little bit in hand' for those hot days stuck in traffic. This proven coolant additive will also cut engine warm-up time in half which will reduce engine wear which is most extreme when the engine is cold. Fully compatible with water and anti-freeze and is safe with cast iron and all alloys.

- 30°F lower operating temperature
- 50% quicker warm up time
- Safe with water/antifreeze mixture
- Safe with cast iron, alloy engines and heads
- Increased engine life!
- 100% biodegradable, non corrosive, non toxic
- For use in all water cooled engines

£13.49
(£11.48 ex vat)



**A MUST FOR
ALL OWNERS**

Description	Part No.	Price £ ex vat	Price £ inc. vat
RADIATOR RELIEF (473ml) Treats 1 engine.	RX1461-473	11.48	13.49

COOL TAPE

Consists of a 1mm aluminised material bonded to a lightweight, woven fibreglass with super strong adhesive backing. Reflects radiant heat. Limitless application, but common uses include wrapping cables, hoses, fuel lines, 'spot' heat retardation areas and sealing gaps in floors or firewalls. The best product on the market!

Flexible, strong adhesive and thin for a tight wrap.

Description	Part No.	Price £ ex vat	Price £ inc. vat
-------------	----------	-------------------	---------------------

COOL TAPE **RX1474 from 19.68 23.12**
Available in 1 3/8" x 15', 1 3/8" x 30' and 2" x 60' rolls

£23.12
(£19.68 ex vat)

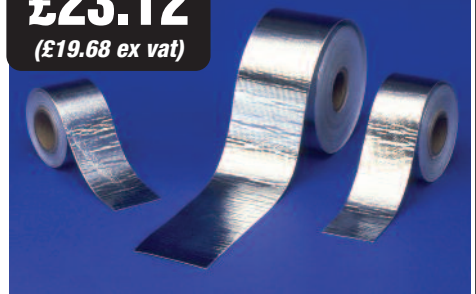

HEAT & SOUND INSULATION MATERIAL

Designed for insulating floors, bulkheads, transmission tunnels and many other applications from the effects of heat, road noise, engine and transmission noise. Made from an aluminium face bonded to a 1/8" composite fibreglass insulation, then backed to an aggressive adhesive. Tough enough for under vehicle applications and harsh environments where high heat can be a problem. Can also block out up to 50% of unwanted noise. Self adhesive, can be cut with tin snips to any shape.

Description	Part No.	Price £ ex vat	Price £ inc. vat
-------------	----------	-------------------	---------------------

INSULATION MATERIAL **RX1473 from 39.41 46.31**
Supplied in 3 sizes: 2' x 21" (3.5sq ft), 4' x 21" (7sq ft), 4' x 42" (14 sq ft).



FROM
£46.31
(£39.41 ex vat)

UNIVERSAL HEAT SHIELD

This multi-purpose heat shield can be used to protect starter motors, carbs, fuel pups, electrical boxes, instruments and hydraulic cylinders from intense heat. Easily cut to shape (scissors or knife) it attaches to itself with velcro material. Simply cut off excess material.

Description	Part No.	Price £ ex vat	Price £ inc. vat
-------------	----------	-------------------	---------------------

UNIVERSAL HEAT SHIELD
7" wide x 24" long **RX1470 37.45 44.00**



£44.00
(£37.45 ex vat)

GENERAL ACCESSORIES

QUIK TAPE - SILICONE RUBBER TAPE

Self adhering and fusing, curing into a solid rubber insulator in less than 24 hours. Resists moisture and temperatures up to 260°C. Gives a tough, permanent insulation seal around electrical connections, hoses, pipes (including exhaust) etc.

£7.25
(£6.17 ex vat)

Quik Tape **RX1479** Ex vat **£6.17** Inc vat **£7.25**
Black. 25mm wide x 0.5mm depth x 3m length.

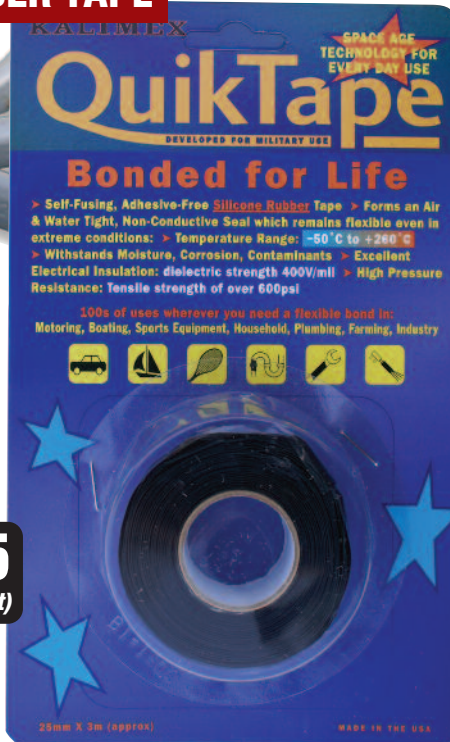

FROM
£23.25
(£19.79 ex vat)

HT LEAD & SPARK PLUG PROTECTION

Protect your HT leads and spark plugs from extreme heat and improve the appearance of your engine bay with these top quality products. Ideal for tubular extractor manifold applications where additional heat is generated, but may be fitted to a standard vehicle.

Note: For Manifold insulation wrap, refer to 'Exhausts' in relevant catalogue.

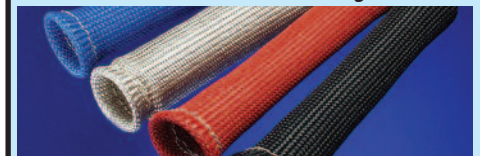

SPARK PLUG SLEEVES

Manufactured from a fibreglass composite material (no arcing), the sleeves slide over the ends of the HT leads, easy installation. Available in silver, black, red or blue.

SPARK PLUG SLEEVES Ex vat Inc vat
2 cylinder kit **RX1462** **£19.79** **£23.25**
Order 2 kits for 4 cylinder, 3 kits for 6 cylinder.
8 cylinder kit **RX1463** **£73.50** **£86.36**



HT LEAD SLEEVES

Made from the same material as the spark plug sleeves - these easy install, snug - fitting sleeves will fit any HT lead up to 10mm in diameter. Also included are hi-temp shrink tubes for a sharp finished appearance. Available in silver, black, red or blue.

HT LEAD SLEEVES Ex vat Inc vat
2 cylinder kit **RX1464** **£16.72** **£19.65**
Order 2 kits for 4 cylinder, 3 kits for 6 cylinder.
8 cylinder kit **RX1465** **£65.07** **£76.46**

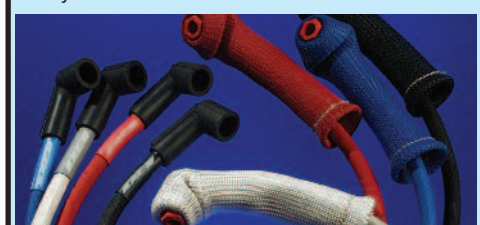

HT LEAD & SPARK PLUG SLEEVE KIT

These kits comprise of both kits listed opposite in one convenient (and cost effective) kit. Colour matched sleeves available in silver, black, red or blue.

HT LEAD & SPARK PLUG SLEEVE KIT Ex vat Inc vat
2 cylinder kit **RX1466** **£34.48** **£40.51**
Includes 7ft of HT lead sleeve, 2 plug sleeves & 6 shrink tubes.
Order 2 kits for 4 cylinder, 3 kits for 6 cylinder.
8 cylinder kit **RX1467** **£133.16** **£156.46**
Includes 25ft of HT lead sleeve, 8 plug sleeves & 25 shrink tubes.

HAND CLEANERS

HICLEAN THE HANDY HAND CLEANER



Hiclean, the handy hand cleaner is a novel and unique hand cleaner that cleans dirty hands quickly without water, soap or towel - ideal for use in any situation! It also moisturises hands and disinfects. Simply apply the gel to your dirty hands and gently rub together until the gel dries and the dirt rolls up and falls off. Hiclean Handy Hand Cleaner may be used repeatedly and is perfectly safe on cut hands. It kills pathogens associated with animals and is suitable for use before meals. Available in tubes or sachets, Hiclean Handy Hand Cleaner contains no perfume and is therefore appropriate to use when animals are present.

Hiclean Handy Hand Cleaner; Ex vat Inc vat
40g Tube **RX1549T** **£2.51** **£2.95**
1.5g 'one-use' sachet **RX1549S** **£0.25** **£0.29**

BEFORE



AFTER

FROM
£0.29
(£0.25 ex vat)



Hiclean Liquid Gloves is a highly effective barrier cream. Simply smother your hands with Liquid Gloves before work commences. To clean, quickly rinse your hands under a cold tap and all the dirt, grease, ink etc simply comes off. Liquid Gloves moisturises hands and stops the pores becoming blocked with dirt. It prevents cracking, chapping and ingrained dirt.

Hiclean Liquid Gloves Ex vat Inc vat
40g Tube **RX1550T** **£2.51** **£2.95**

POWER SOURCE INVERTOR

POWER SOURCE INVERTOR

A power source inverter converts car battery voltage (12v) into a 240v output. You can plug in a variety of mains voltage appliances into the standard uk socket. Three different invertors are available to suit a range of power requirements. There is overload, overheat and short circuit protection on all models.

FROM
£34.99
(£29.78 ex vat)



500 WATT MODEL, RX1551-500

Great for in car entertainment and leisure use!

Description	Part No.	Price ex vat	Price inc. vat
-------------	----------	--------------	----------------

150 WATT MODEL

Continuous power: 150w. Peak power: 300w
Cigar lighter plug connection. 15A fuse.
Suitable applications: TV, DVD, Video, Computer Consoles, Lights (not fluorescent) Phone charger etc.

RX1551-150 **£29.78** **£34.99**

300 WATT MODEL

Continuous power: 300w. Peak power: 660w
Cigar lighter or battery clip connection. 40A fuse.
Suitable applications: as 150w model plus small power tools, small fridges, stereo etc.

RX1551-300 **£38.26** **£44.96**

500 WATT MODEL

Continuous power: 500w. Peak power: 800w
Battery clip connection only. 70A fuse.
Suitable applications: as 300w model plus medium power tools, colour TV's with DVD's, battery chargers etc.

RX1551-500 **£54.43** **£63.96**

GENERAL ACCESSORIES

BODY CARE



FROM
£1.95
(£1.66 ex vat)

AUTOGLYM CAR CARE PRODUCTS INDIVIDUAL ITEMS

Description	Part No.	Price £ ex vat	Price £ inc. vat
Silicone Resin Polish (325ml)*	RX1312	7.61	8.94
Bodywork Shampoo/Conditioner (500ml)*	RX1313	5.10	5.99
Car Interior Shampoo (500ml)*	RX1314	4.25	4.99
Glass Polish (325ml)*	RX1315	4.25	4.99
Cutting Polish (325ml)*	RX1316	4.25	4.99
Ultra Deep Shine (500ml)	RX1558	9.35	10.99
Extra Gloss Protection (325ml)*	RX1317	6.80	7.99
Bumper Care (325ml)*	RX1318	4.68	5.50
Vinyl & Rubber Care (500ml)*	RX1319	5.75	6.76
Leather Care Cream (325ml)*	RX1320	8.50	9.99
Superglym Chrome Polish (55g)*	RX1321	4.25	4.99
Clean Wheels (500ml)*	RX1322	5.10	5.99
Perfect Polishing Cloth (21sq ft)*	RX1323	5.53	6.50
Aqua Dry (Synthetic Chamois)*	RX1324	7.23	8.50
Clean Machine (1 Litre)*	RX1325	6.35	7.46
Hood Care & Maintenance Kit	RX1433	17.01	19.99
Instant Tyre Dressing	RX1368	5.10	5.99
Intensive Tar Remover	RX1367	4.25	4.99
Alloy Wheel Seal (450ml) Silicone spray.	RX1443	4.25	4.99

OTHER CAR CARE PRODUCTS

Sponge	RX1415	1.66	1.95
--------	--------	------	------

AUTOGLYM CAR CARE KITS

The following kits work out cheaper than purchasing individual items.

Description	Part No.	Price £ ex vat	Price £ inc. vat
BASIC CAR CARE KIT Contents include: Bodywork Shampoo, Resin Polish, Sponge.	RX4079	12.31	14.46
WASH'N'POLISH KIT Contents include: Bodywork Shampoo, Resin Polish, Sponge, Glass Polish, Polishing Cloth, Aquadry.	RX4080	26.73	31.41
HOME VALET KIT Contents include: Bodywork Shampoo, Resin Polish, Sponge, Vinyl & Rubber Care, Polishing Cloth, Aquadry, Clean Wheels.	RX4081	30.85	36.25
FINISHING TOUCHES KIT Contents include: Glass Polish, Extra Gloss, Vinyl & Rubber Care, Chrome Polish, Bumper Care, Polishing Cloth.	RX4082	27.50	32.31
INTERIOR CARE KIT Contents include: Vinyl & Rubber Care, Interior Shampoo, Leather Care, Polishing Cloth.	RX4083	16.43	19.31
CONNOISSEUR KIT Contents include: Silicone Resin Polish, Bodywork Shampoo/Conditioner, Car Interior Shampoo, Glass Polish, Cutting Polish, Ultra Deep Shine, Extra Gloss Protection, Bumper Care, Vinyl & Rubber Care, Leather Care Cream, Superglym Chrome Polish, Clean Wheels, Perfect Polishing Cloth, Aquadry, Clean Machine.	RX1510	69.53	81.70

AUTOGLYM GIFT PACK & CASE SETS

IDEAL PRESENTS!

These Gift Packs all come in a high quality holdall and make ideal presents.

Description	Part No.	Price £ ex vat	Price £ inc. vat
-------------	----------	-------------------	---------------------



COSMETIC COLLECTION RX1582 41.28 48.50

Contents include: Super Resin Polish (325ml), Clean Wheels (500ml), Jumbo Wash Sponge, Paint Renovator (325ml), Perfect Polishing Cloth, Bodywork Shampoo Conditioner (500ml), Intensive Tar Remover (325ml), Car Glass Polish (325ml), Quick Clear Screenwash (500ml), Bumper Care (325ml), 36 page full colour Car Care guide, Free Pink Vent Mount Air Freshener.



CONCOURS COLLECTION RX1583 59.53 69.95

Contents include: Instant Tyre Dressing (500ml), Interior Shampoo (500ml), Leather Care Cream (325ml), Fast Glass (500ml), Custom Wheel Cleaner (500ml), Bodywork Shampoo Conditioner (325ml), Autofresh (500ml), Bumper Care (325ml), Ultra Deep Shine (500ml), Leather Cleaner (500ml), Hi-Tech Flexi Water Blade, Hi-Tech Finishing Cloth, Hi-Tech Wheel Brush, Aqua Dry, 36 page full colour Car Care guide, All presented in a limited edition black very high quality holdall.



VALET COLLECTION RX1584 37.45 44.00

Contents include: Super Resin Polish (325ml), Clean Wheels (500ml), Jumbo Wash Sponge, Paint Renovator (325ml), Perfect Polishing Cloth, Bodywork Shampoo Conditioner (500ml), Intensive Tar Remover (325ml), Car Glass Polish (325ml), Quick Clear Screenwash (500ml), Bumper Care (325ml), 36 page full colour Car Care guide.

FINNEGANS 'ANTI-CORROSION' WAXOYL

Description	Part No.	Price £ ex vat	Price £ inc. vat
Waxoyl starter kit (Inc. RX1028, RX1030, RX1031)	RX1032	47.66	56.00
Waxoyl;			
5 Litre can	RX1027	33.19	39.00
2.5 Litre cartridge	RX1028	22.09	25.96
Trigger spray gun	RX1033	14.89	17.50
High pressure spray gun (Use with 2.5 litre cartridge)	RX1030	22.09	25.96
Aerosol;			
400ml clear	RX1026	8.25	9.69
200ml clear	RX1025	4.04	4.75
400ml black	RX1035	8.25	9.69
Underbody seal;			
1 litre	RX1024	6.77	7.95
500ml	RX1023	3.96	4.65



FROM
£4.65
(£3.96 ex vat)

WAXOYL
The Original

GENERAL ACCESSORIES

HOOD CARE

A range of products to clean, renovate and protect your hood cover, tonneau cover or hood stowage cover, whether made from vinyl, canvas or mohair material.



FROM
£9.74
(£8.29 ex vat)

Description	Part No.	Price £ ex vat	Price £ inc. vat
Vinyl Top Cleaner (500ml)	RX1529	8.29	9.74
Dry Cleaner Shampoo - Canvas/mohair (300ml)	RX1530	11.87	13.95
Soft Top Reviver - Canvas/mohair Available in black, blue & brown.			
500ml size	RX1525	16.13	18.95
1 Litre size	RX1524	27.65	32.49
Ultra Proofer - Canvas/mohair			
500ml size	RX1527	12.34	14.50
1 Litre size	RX1526	19.53	22.95
Ultra Proofer - Vinyl (500ml)	RX1528	8.29	9.74
Plastic Window Polish			
50ml size	RX1531	9.14	10.74
100ml size	RX1532	14.89	17.50

GENERAL CONSUMABLES

Description	Part No.	Price £ ex vat	Price £ inc. vat
WD-40 (Large 400ml)	GAC111	3.36	3.95
Wonderweld (Holts); 250ml	RX1539-250ML	8.94	10.94
500ml	RX1539-500ML	12.98	15.25
Radweld (Holts, 250ml)	RX1508	2.54	2.98
Easystart (Bradex, 280ml)	RX1511	2.98	3.50
Instant Gasket (Tube 38g)	GHF6093	3.66	4.30
Hylomar (Gasket Sealant) (100g)	GGC102	5.06	5.95
Exhaust Joining Compound	GCH112	3.23	3.80
Copper Ease (Tube) (Anti-Seize Grease) 95g	RX1345	2.51	2.95
Brake Rubber Grease	514578P	2.30	2.70
Brake Cleaner (Aerosol)	GBF901	3.06	3.60
Loctite (Tube); 3ml	GAC1003ML	2.68	3.15
24ml	GAC10024ML	16.12	18.94
Adhesive (Trim/Carpets); 1 Litre Tin	RX1353	12.77	15.00
Aerosol (500ml)	RX1353A	11.70	13.75
Seam Sealer (Canvas Hoods)	RX1257	5.11	6.00
Tyreweld Aerosol (Holts); 300ml	GAC9903X-300ML	5.92	6.96
400ml	GAC9903X-400ML	8.30	9.75
Waterproofing - Hood Material Clear 1 Litre	RX1373	6.17	7.25
Latex/Rubber Gloves (Pack of 100)	RX1406	3.56	4.18



FROM
£2.98
(£2.54 ex vat)



HAYNES OWNERS WORKSHOP MANUAL - MAN

All models, shapes, sizes and colours,
120,000BC to present day.

Man Manual (2nd edition)

The definitive step-by-step guide to men's health
The first edition of this book became an international best-seller. This new edition, now all in colour, has been revised and updated to take account of developments in the fast-moving world of health care and disease prevention. New material includes sections on asthma, allergies, diabetes, metabolic syndrome and statins.

Men are far more likely to look after their cars than their own bodies!

Reading this could mean the difference between a healthy, high mileage life and premature breakdown.
By Dr Ian Banks. 160 pages, 200 colour illustrations.

Description	Part No.	Price £ ex vat	Price £ inc. vat
'Man' Haynes Manual	RX1534	14.50	14.50

Overcooled *or* Overheated?

Ensure correct engine temperature with a



thermo-electric

fan



Tailbacks need hold no fears with a modern day Kenlowe thermo electric cooling fan. Blower or suction models are available from 7 to 17 inch, to suit almost every car. Use for secondary additional cooling or in place of the belt driven fan to release engine power. Complete, easy to fit, DIY kits with mountings, automatic thermal control, and everything you need. We stock Kenlowe fan packages for all classics and most other vehicles - you will be surprised at the fuel saving and the peace of mind you have in traffic with a Kenlowe fan. Kenlowe are proud to have been suppliers to Rimmer for over 25 years.

Kenlowe pioneered thermo electric engine cooling world-wide over 50 years ago and still make the most powerful, most advanced fans you can buy. Deep profile, curved blades build pressure to overcome radiator resistance without excessive amps, ensuring more air out and more heat taken away! Current original equipment vehicle manufacturers of note trust curved blades to deliver the cooling needed, making straight (including sweptback straight) or 'wedge shaped' blades, yesterday's designs.

AIRFLOW PERFORMANCE BY
MIRA

FANS to BSI
ISO 9001
TS 16949

The fan with a pedigree that won't let you down



QUICKFINDER CATALOGUE LISTINGS

The following sections (in model order) list out popular parts for all MG Rover's, MGB, Midget/AH Sprite, Rover P5 & P6 and New MINI.

HOW TO USE THIS QUICKFINDER

Popular Part Numbers are listed in the Quickfinder listings section - pages 68 to 123 (for the full range refer to website).

Prices are listed in the price section - pages 124 to 151.

- 1) First find the Part Number(s) for the part(s) you require in the Quickfinder listings section.
- 2) Look up the prices in the price section. (Preferably, refer to website for up-to-date prices, as they can change).

GENUINE MG ROVER PARTS

We stock a vast range of genuine MG Rover parts in addition to those listed here. This Quick Finder is intended as a summary listing only for the most popular parts for each model.

The full range of products we offer, some 600,000 individual part numbers, can only be found on-line in our Electronic Parts Catalogue, where we have line drawn parts diagrams, model range information, photographs, fitting instructions and live stock availability (see page 4 for more detail).

Our website also features news, new products, shopping by brand and clearance lines at bargain prices



AFTERMARKET PARTS

Aftermarket (or Pattern Parts) are sometimes sold alongside genuine MG Rover (OE) parts, often with a considerable cost saving (see page 3 for details).

To help identify these parts in the pricing section (page 124 to 151 or on our website), we suffix the end of the MG Rover part number with a 'P' (for Pattern). Sometimes there are other variants of the same part number, for example 'UR' for uprated, or 'SS' for Stainless Steel. It is therefore easy to compare prices and see if there are alternatives available.

INDEX

MGF & MG TF	69
MG ZR / ROVER 25 / STREETWISE	79
MG ZS / ROVER 45	82
MGB	85
MG MIDGET & AUSTIN HEALEY SPRITE	88
ROVER 75 V8 / ZT260	90
ROVER 75 / ZT / ZT-T	91
CITY ROVER	94
ROVER MINI	95
NEW MINI	98
MG METRO	100
ROVER 100 / METRO	101
ROVER 200	103
ROVER 200 / 400	105
ROVER 200 COUPE / CABRIOLET, 400 TOURER	108
ROVER 400	110
ROVER 600	112
ROVER 800 (91-96)	114
ROVER 800 (96 ON)	115
ROVER P5 & P6	117
MONTEGO	118
MAESTRO	120
PRICES	124

**EASY TO USE ON LINE
ORDERING WITH
PARTS DIAGRAMS &
PHOTOGRAPHS**



www.rimmerbros.co.uk



MG F (SEP 95 TO FEB 02) & MG TF (FEB 02 ON)

PRICES
SEE PAGES 124-151
OR VISIT OUR
WEBSITE



SERVICE PARTS

MG F (SEP 95 TO FEB 02) & MG TF (FEB 02 ON)

SERVICE KIT

inc Air Oil, Fuel Filters and 4 Sparkplugs
All models up to YD522572
All models from YD522573

RP1013
RP1014

AIR FILTERS

All models, up to YD522572
All models, from YD522573

PHE100421
PHE100540

K&N REPLACEMENT PANEL FILTER

Fits in standard air box.

All Models, up to YD522572

PHE100421K-N

K&N "571" INDUCTION KIT

Inc. Intake duct, Filter & Cold Air Hose

MG F 1.8 (inc. VVC)

MG TF 1.8 (135 & 160 BHP)

RP1026
RP1027

FUEL FILTER All models

WJN101191

OIL FILTER All models

LPW100181

OIL FILTER REMOVAL STRAP WRENCH (1/2" Drive)

All Models

RX1514

WASHER-SEALING - 14mm - sump drain plug

All models

ALU1403L

ENGINE OIL X POWER FULLY SYNTHETIC 5W-40

1 litre All models

5 litre All models

XP540FS1
XP540FS5

MTF 94 MANUAL TRANSMISSION GEARBOX OIL

2.5 litre All models, manual

VYK000020

EZL999 AUTOMATIC TRANSMISSION FLUID

1 Litre All models, automatic

XPT0010020F

TEXACO HAVOLINE XLC (Extended Life Coolant)

Antifreeze 1 Litre All models

Antifreeze 5 Litres All models

XP1LL
XP5LL

SPARK PLUGS Champion Long Life

All models

NLP100290

WIPER BLADE, DRIVERS

All models, RHD - ex Australia

Australia

All models LHD

DKC000190
DKC100840
DKC100670

WIPER BLADE, PASSENGERS

All models, - ex Australia

Australia

All models LHD

DKC100660
DKC100850
DKC100660

FUEL PUMPS

All models, up to YD522572

All models, from YD522573 up to 4D634733

All models, from 4D634734

WFX100670
WFX101320
WFX101321

TIMING BELTS

1.6/1.8 Petrol, 26mm wide,
auto tensioning - exc: VVC

1.8 Petrol, 23mm wide - exc: VVC

1.8 Petrol VVC, front

1.8 Petrol VVC, rear

LHN100560
CDU2749
LHN100390
LHN100400

TIMING BELT TENSIONERS

Tensioner 1.6/1.8 auto tensioning

Tensioner 1.8 without auto tensioning and VVC

LHP100900
LHP10015

ALTERNATOR BELTS

All models - exc: air-con

All models, air-con only

PQS100840
PQS101180

DISTRIBUTOR CAP

All models, up to YD522572- exc: VVC

NJD10010

ROTOR ARM

All models, up to YD522572- exc: VVC

NJE100070SLP

ENGINE - CYLINDER HEAD & FITTINGS

MG F (SEP 95 TO FEB 02) & MG TF (FEB 02 ON)

CAMSHAFT ASSEMBLY

Engine - inlet, exhaust - inlet and exhaust

All models up to 2D600100 - exc VVC

All models from 2D600101 - exc VVC

Engine inlet - RH, front 1.8 VVC

Engine inlet - LH, rear 1.8 VVC

Engine exhaust 1.8 VVC

LGC106960
LGC000280
LXV100140
LXV100150
LGC107430

BUSH-DRIVE SPINDLE DISTRIBUTOR

All models up to 18K4FJ31196826 or

18K4FJ32197073- exc: VVC

NJJ10001

PIN - roll All models up to 18K4FJ31196826 or

18K4FJ32197073 & VVC

PA112150

SEAL - camshaft oil - Black, front

All models

LUC100290SLP

SEAL - camshaft oil - Red, rear All models

LUC100220SLP

SEAL - variable valve timing housing 1.8 VVC

LQJ100950



K&N "571" INDUCTION KIT
- RP1026

SCREW - flanged head - housing to cylinder head

1.8 VVC

LYP10003

CYLINDER HEAD GASKET

All models

LVB000320SLP

New Land Rover Multi Layer Spec All models

LVB500190

OIL RAIL - New Land Rover Spec

(use with MLS Head Gasket) All Models

LCN000140L

CYLINDER HEAD BOLT All models

WAM2293

COVER ASSEMBLY - camshaft carrier

Manual - exc VVC

Automatic

LDR103260
LDR104511

GASKET - camshaft cover

Manual - exc VVC

Automatic and VVC models

WAM4116EVA
LVP100630

COVER - camshaft carrier 1.8 VVC

LDR000431

BOLT - flanged head - camshaft cover

All models

FB106067A

CAP - oil filler - Yellow All models

COVER - spark plug All models

PLATE - camshaft cover blanking

All models -exc VVC

LDR103810

HYDRAULIC CONTROL UNIT ASSEMBLY -

less solenoid control valve 1.8 VVC

LXS100080

SOLENOID AND VALVE - hydraulic control unit

1.8 VVC

LGH101350

SEAL - hydraulic control unit to camshaft carrier

1.8 VVC

LJQ100920SLP

CYLINDER HEAD ASSEMBLY - engine - with valves -

auto tensioning All models -exc VVC

LDF109380

CYLINDER HEAD/CAMSHAFT CARRIER ASSEMBLY -

engine - less valves

1.8 VVC - exc 160PS

1.8 VVC 160 PS from YD530689

LDF108520

LDF000980

GUIDE - cylinder head valve -

Standard, plain All models

Grooved and stepped, salvage All models

LGJ10034

LGJ101060

INSERT - inlet valve seat-cylinder head

All models -exc VVC

LGK101160

LGK101140

INSERT - cylinder head exhaust valve seat

All models -exc VVC

LGK101170

LGK101150

DOWEL - ring All models

BOLT - flanged head - M6 x 30 All models

VALVE - cylinder head

inlet All models -exc VVC

inlet 1.8 VVC

exhaust All models -exc VVC

exhaust 1.8 VVC

LGH10029

LGH10064

LGH101190

LGH101360

SEAL - cylinder head valve stem oil All models

LUB100350

SPRING - cylinder head valve

All models -exc VVC

LGL10008

LGL100460

CAP - cylinder head valve spring All models

COLLET - cylinder head valve All models

UAM3797L

LGN10004

TAPPET - engine valve hydraulic

All models -exc VVC

1.8 VVC

LGR000050

LGR100330

ENGINE - BREATHER SYSTEM

MG F (SEP 95 TO FEB 02) & MG TF (FEB 02 ON)

HOSE - camshaft cover to inlet manifold breather

Manual Early

Manual Late

Automatic - exc VVC

to throttle body breather

Manual Early

Manual Late

Automatic - exc VVC

LLH102210A

LLH102380

LLH102210A

LLH102280

LLH102390

LLH102801

ENGINE - EXHAUST MANIFOLD

MG F (SEP 95 TO FEB 02) & MG TF (FEB 02 ON)

CONVERTER ASSEMBLY - manifold exhaust system

All models from 1D521460

LKC103240

GASKET - exhaust manifold All models

LKG100300

LOCKNUT - M10 - exhaust manifold to cylinder head

All models

ERR597

STUD - M10 x 25 - exhaust manifold to exhaust downpipe

All models

TE110051

NUT - spring-self thread

All models from 1D521460

AK614017

ENGINE - GASKET SETS

MG F (SEP 95 TO FEB 02) & MG TF (FEB 02 ON)

HEAD GASKET SET - STD

1.6 and 1.8 non VVC

LVQ000090SLP

1.8 VVC

LVQ000102SLP

NEW MULTI LAYER GASKET SET & OIL RAIL KIT

ZUA000080

BOTTOM END GASKET SET All models

LVQ000070

LIQUID LADDER GASKET All models

LVV000108EVA

ENGINE - INLET MANIFOLD

MG F (SEP 95 TO FEB 02) & MG TF (FEB 02 ON)

MANIFOLD ASSEMBLY - engine inlet

All models - exc VVC

LKB107560

Blanked A.I.T sensor port All models - exc VVC

LKB109291

GASKET - inlet manifold

All models -exc VVC

LKJ101110SLP

STUD - M8 x 25 - inlet manifold

All models - exc VVC

TE108065M

NUT - flange - M8 - inlet manifold to cylinder head



PRICES
SEE PAGES 124-151
OR VISIT OUR
WEBSITE

MG F (SEP 95 TO FEB 02) & MG TF (FEB 02 ON)



ENGINE - SUMP & FITTINGS MG F (SEP 95 TO FEB 02) & MG TF (FEB 02 ON)

STRAINER AND PIPE ASSEMBLY - oil All models	LSP10027
O RING - oil suction pipe seal All models	CDU2206
SUMP ASSEMBLY - engine oil All models	LSB000390
PLUG - sump assembly oil drain All models	LSF100040L
WASHER - sealing - 14mm - sump drain plug All models	ALU1403L
SCREW - flanged head - M8 x 25 All models	FT108255L
BOLT - flanged head All models	FC108125
OIL RAIL - New Land Rover Spec (use with MLS Head Gasket) All models	LCN000140L
KIT - bearing ladder liquid gasket replacement - 25ml Tube All models	LVV000010

ENGINE - BLOCK & FITTINGS MG F (SEP 95 TO FEB 02) & MG TF (FEB 02 ON)

CYLINDER LINER All models	LCJ000050SLP
SEALANT - for use when Fitting Cylinder Liner K series Engine Models	LVV000108EVA
PULLEY - crankshaft All models	LHG000010

ENGINE - TIMING BELTS & FITTINGS MG F (SEP 95 TO FEB 02) & MG TF (FEB 02 ON)

GEAR - crankshaft timing drive All models	LHH100480
BOLT - crankshaft pulley All models	WAM4243
WASHER - crankshaft pulley All models	LYF10051
PULLEY - camshaft timing belt driven All models -exc VVC exhaust 1.8 VVC inlet 1.8 VVC	LHB101360 LHB101330 LHB101190
WASHER - cam pulley All models	LYF000020
BOLT - cam pulley All models	SX110350
BELT - engine timing - 23mm wide - without auto tensioning All models -exc VVC	CDU2749
26mm wide - auto tensioning All models -exc VVC 1.8 VVC	LHN100560 LHN100390
TENSIONER - timing belt - without auto tensioning All models auto tensioning All models -exc VVC	LHP10015 LHP100900
TIMING BELT KIT - (includes belt & tensioner) 1.6/1.8 Petrol, 23mm wide, non auto tensioning - exc: VVC	RP1071
26mm wide, auto tensioning - exc: VVC 1.8VVC	RP1078 RP1079
CAM GEAR LOCKING TOOL	18G1570
SPRING & SLEEVE ASSEMBLY - belt tensioner - without auto tensioning All models -exc VVC	LHR10005
BOLT - timing belt tensioner pedestal - without auto tensioning All models	WAM3885
CAPSCREW - M10 x 25 -tensioner 1.8 VVC	SS110251
SCREW - flanged head - M6 x 14 - tensioner 1.8 VVC	FS106141
BOLT - adhesive-patch - auto tensioning All models - exc VVC	LYG101460
BOLT - shouldered-timing belt cover special - auto tensioning All models - exc VVC	LHT100060
COVER ASSEMBLY upper rear timing cover All models -exc VVC 1.8 VVC	LJR104320 LJR104760
upper front timing belt All models - exc VVC 1.8 VVC	LJR104000 LJR104770
SCREW M6 x 14 All models M6 x 25 All models	LYP10005 LYP10008
SEAL coolant pump All models timing cover upper All models	LJQ10003L LJQ10008L
BOLT flanged head - upper timing cover M6 x 55 All models M6 x 35 1.8 VVC M6 x 14 All models	FB106115 FB106075 DBP1420

SCREW - flanged head - upper timing cover M6 x 20 All models -exc VVC M6 x 16 1.8 VVC	FS106205 FS106165 LJR104350L
COVER - lower front timing belt All models	
SEAL timing cover All models timing cover lower All models	LJQ10007L LJQ10001L
SCREW - M6 x 16 - timing belt cover lower All models	LYG10015
PULLEY - camshaft - rear 1.8 VVC	LHB101230
WASHER - cam pulley 1.8 VVC	LYF000020
BOLT - cam pulley 1.8 VVC	SX110350
BELT - engine timing - rear 1.8 VVC	LHN100400
COVER ASSEMBLY - rear timing belt inner 1.8 VVC	LJR000110 LJR000120
COVER - rear timing belt - outer 1.8 VVC	FS105101
SCREW - nylon patch - M5 1.8 VVC	FS106205
SCREW - flanged head - M6 x 20 1.8 VVC	

BRAKING - MASTER CYLINDER & SERVO MG F (SEP 95 TO FEB 02) & MG TF (FEB 02 ON)

MASTER CYLINDER MG F without anti lock brakes to AD505 from AD506 to YD525453 MG F with Anti Lock brakes to YD525453 All models from YD525454	SJC10005 SJC10007 SJC10007 SJC000150
MASTER CYLINDER REPAIR KIT All models without Anti Lock Brakes All models with Anti Lock Brakes	SJJ100240 SJJ100250
SERVO All models to 5D639633 All models from 5D639634	SJG100270 SJG000160
SERVO VACUUM HOSE MG F RHD MG F LHD MG TF RHD MG TF LHD	SQB101961 SQB101971 SQB000180 SQB000190
SERVO TO MASTER CYLINDER O RING All models	EJP1504
BRAKE PEDAL PAD All models, Manual All models, Automatic	DBP7047 DBP7056

BRAKING - ANTI LOCK SYSTEM MG F (SEP 95 TO FEB 02) & MG TF (FEB 02 ON)

ANTI LOCK BRAKE MODULATOR MG F to XD511058	SRB100550
ELECTRONIC CONTROL UNIT - Anti Lock Brake Modulator MG F to XD511058	SRD100180
ANTI LOCK BRAKE MODULATOR including ECU MG F from XD511059 and MG TF	SRB101590
SENSOR ANTI LOCK BRAKE Front All models Rear All models, RH Rear All models, LH	SSB100790 SSB100881 SSB100891
ADAPTOR ANTI LOCK BRAKE SENSOR All models, RH front or LH rear All models, LH front or RH rear	SSE100430 SSE100440
SCREW M6 x 10 Anti Lock Brake Sensor Adaptor to Hub, Front All models	FS106107
BOLT M6 x 35 Anti Lock Brake Sensor Adaptor to Hub, Rear All models	FB106071

BRAKING - DISCS, CALIPERS & FITTINGS MG F (SEP 95 TO FEB 02) & MG TF (FEB 02 ON)

STANDARD BRAKE DISC front each All models -exc: Trophy/MG TF160 front each Trophy/ MG TF160 rear each All models	NAM7806 SDB000231 SDB100460 SF106161L
SCREW BRAKE DISC All models	
UPRATED EBC BRAKE DISC front pair All models -exc: Trophy/MG TF160 Trophy/ MG TF160 rear pair All models	NAM7806UR SDB000231UR SDB100460UR

STANDARD BRAKE PADS front (1 Set inc fittings) All models -exc: Trophy/MG TF160 rear (1 Set inc fittings) All models rear (1 Set) All models	SEM100020 SFP000310 SFP000360 SFP100360SLP
UPRATED EBC BRAKE PADS front (1 Set) All models -exc: Trophy/MG TF160 Trophy/ MG TF160 rear (1 Set) All models	SEM100020 GS SFP000310 GS SFP000360 GS
FRONT BRAKE KIT (includes Discs & Pads) All Models (exc. TF160 & Trophy) TF160 & Trophy Models	RP1019 RP1018
FRONT - UPRATED EBC BRAKE KIT Includes Turbo Groove Discs & Greenstuff Pads. All Models (exc. TF160 & Trophy) TF160 & Trophy Models	RP1019UR RP1018UR
CALIPER Front All models LH - exc: Trophy/MG TF160 RH - exc: Trophy/MG TF160 LH - Trophy/ MG TF160 RH -Trophy/ MG TF160 Rear LH - All models RH -All models	SEG10006 SEG10005 SEB000350 SEB000340 SMC000470 SMC000460
CARRIER Front Caliper All models -exc: Trophy/MG TF160	SEH10003
CALIPER REPAIR KIT Front All models -exc: Trophy/MG TF160 Trophy/ MG TF160 Rear All models	SEE10002 SEE000030 CDU3822
BLEED SCREW Caliper front or rear All models - exc: Trophy/MG TF160	RTC1115A
WHEEL BEARING KIT front/rear All models	RFM000050
DRIVE FLANGE - Hub, Front & Rear All models	RUB000150
BRAKING - HOSES MG F (SEP 95 TO FEB 02) & MG TF (FEB 02 ON)	
FRONT BRAKE HOSE MG F, LH MG F, RH MG TF	SHB10007SLP SHB10006SLP SHB000870
REAR BRAKE HOSE MG F MG TF	SHB100611 SHB000280
BANJO BOLT Front Brake Hose All models	SYG100510L
COPPER WASHER for Banjo Bolt All models	BNP1244L
GOODRIDGE STAINLESS STEEL BRAIDED BRAKE HOSE SET MG F MG TF	RP1034 RP1035
BRAKING - HANDBRAKE MG F (SEP 95 TO FEB 02) & MG TF (FEB 02 ON)	
HANDBRAKE CABLES All models, RH LH	SPB000600P SPB000610
CABLE PIN (to caliper) All models	CLP7352
LEVER ASSEMBLY COMPLETE Black Leather with Chrome Button All models	SNB000280RHT
BRAKING - GENERAL MG F (SEP 95 TO FEB 02) & MG TF (FEB 02 ON)	
BRAKE CLEANER Aerosol 500ml All models	GBF901
UNIVERSAL DOT 4 BRAKE AND CLUTCH FLUID 250ml All models 500ml All models 1 Litre All models	SIJ000010 SIJ000020 L3PFB401
SILICON LONG LIFE DOT 5 BRAKE AND CLUTCH FLUID 500ml All models 1 Litre All models	RX1327 RX1326
COPPER EASE GREASE 85gm Tube All models	RX1345
RED RUBBER GREASE 7gm Sachet All models	514578P
DRAPER REAR BRAKE CALIPER PISTON	
WIND BACK TOOL All models	RP1112

MG F & MG TF



MG F (SEP 95 TO FEB 02) & MG TF (FEB 02 ON)

PRICES
SEE PAGES 124-151
OR VISIT OUR
WEBSITE



CLUTCH - FRICTION PARTS & FITTINGS MG F (SEP 95 TO FEB 02) & MG TF (FEB 02 ON)

CLUTCH KITS	
1.8 Petrol, manual	URF000121
1.6 Petrol, manual	URF000160
CLUTCH COVER	
1.6 Petrol, manual	URB000170
1.8 Petrol, manual	URB10009
CLUTCH PLATES	
1.6 Petrol, manual	UQB000091
1.8 Petrol, manual	UQB000221
1.8 Petrol, auto.	UQB000060
CLUTCH RELEASE BEARINGS	
All models, manual	UTJ100170
SCREW M8 X 16 Clutch Cover Retaining	
All models, manual	FS108161

CLUTCH - MASTER CYLINDER & FITTINGS MG F (SEP 95 TO FEB 02) & MG TF (FEB 02 ON)

CLUTCH MASTER CYLINDER	
All models, manual	STC100083
CLUTCH MASTER CYLINDER REPAIR KIT	
All models, manual	STY000020
CLUTCH MASTER CYLINDER CAP	
All models, manual	STW000010
SCREW M8 X 25 Clutch Master Cylinder Retaining	
All models up to XD500389, manual	FS108257L
All models from XD500390, manual	LYG10040L
NUT M8 Clutch Master Cylinder Retaining	
All models, manual	FN108041
CLEVIS PIN for Clutch Master Cylinder	
All models, manual	PC108241
WASHER M8 for Clevis Pin	
All models, manual	WA108051L
SPRING Steel Retaining Clip for Clevis Pin	
All models, manual	EDP7864
GASKET Clutch Master Cylinder to Mounting Plate	
All models, manual	NAM1394
CLUTCH DAMPER 1.8 VVC to XD507922	
	AAU8008A

CLUTCH - SLAVE CYLINDER & FITTINGS MG F (SEP 95 TO FEB 02) & MG TF (FEB 02 ON)

CLUTCH SLAVE CYLINDER	
All models, manual	UUB100040
CLUTCH SLAVE CYLINDER REPAIR KIT	
All models, manual	UUB100180
CLEVIS PIN for Clutch Slave Cylinder	
All models, manual	PC108321A
SPRING Steel Retaining Clip for Clevis Pin	
All models, manual	NAM6385
SCREW	
M10 x 20 Clutch Slave Cylinder Bracket to Engine Mounting	FS110207L
All models, manual	
M8 x 20 Clutch Slave Cylinder to Bracket	FS108207
All models, manual	
CLUTCH HOSE	
to Slave Cylinder All models, manual	STG000080
to Underfloor Pipe All models, manual	STH100170
CLUTCH PIPE from Master Cylinder	
All models, manual, RHD - exc VVC	STG100762
All models, manual, LHD - exc VVC	STG100772
1.8 VVC to XD507922	STG101010

CLUTCH - FORK & FITTINGS MG F (SEP 95 TO FEB 02) & MG TF (FEB 02 ON)

CLUTCH FORK	
All models, manual	UTB100140
CLUTCH SHAFT & LEVER ASSEMBLY	
All models, manual	UTC100100
BUSH KIT Clutch Shaft	
All models, manual	UNM100010
BOLT M8 x 28 Clutch Fork Mounting	
All models, manual	DBM588L
SPRING WASHER 8mm Clutch Fork Mounting	
All models, manual	DBM589

CLUTCH - PEDAL SHAFT & FITTINGS MG F (SEP 95 TO FEB 02) & MG TF (FEB 02 ON)

CLUTCH PEDAL	
All models, manual,	
RHD	SUC100282PMA
LHD	SUC100292PMA
CLUTCH PEDAL PAD	
All models, manual	DBP7047
BUSH Clutch Pedal to Shaft	
All models, manual	NAM6875

CIRCLIP Clutch Pedal Retaining	
All models, manual	FAM3903
SPRING Clutch Pedal Return	
All models, manual	EGP1529
BUSH Clutch Return Spring	
All models, manual	EJP1380

BRACKET AND SHAFT ASSEMBLY Clutch Pedal	
All models, manual	SKU100871

FLANGED NUT M8 for Clutch Shaft	
All models, manual	FN108041

PLATE, Clutch Pedal Mounting Bracket	
All models, manual	SKU100580

SEAL FOR PLATE, Clutch Pedal Mounting	
All models, manual	NAM9348

SCREW M8 X 16 Clutch Bracket and Shaft Retaining	
All models, manual	FS108161

SCREW M6 X 16 Clutch Bracket Plate Retaining	
All models, manual	FS106165

CLUTCH - GENERAL MG F (SEP 95 TO FEB 02) & MG TF (FEB 02 ON)

UNIVERSAL DOT 4 BRAKE AND CLUTCH FLUID	
250ml All Models	SIJ000010
500ml All Models	SIJ000020
1 Litre All Models	L3PFB401

SILICON LONG LIFE DOT 5 BRAKE AND CLUTCH FLUID	
500ml All Models	RX1327
1 Litre All Models	RX1326

RED RUBBER GREASE 7gm Sachet All Models	
	514578P

GEAR SELECTOR CABLE	
(Cross Gate) All Models	ULS100060
All models Up To 2D600100	ULS100070
All Models From 2D600101	ULS000011

COOLING - RADIATORS & FITTINGS MG F (SEP 95 TO FEB 02) & MG TF (FEB 02 ON)

WATER PUMP With Evaporation Chamber	
All models	PEB102510SLP

WATER PUMP O RING	
All models	PET10010L

RADIATORS	
MG F	PCC105740SLP
MG TF	PCC001140SLP

RADIATOR BLEED SCREW	
MG F	PYP100500

RADIATOR MOUNTING RUBBER	
All models	PCG100231

BRACKET - radiator upper mounting	
All models	ABU460310

SCREW - flanged head - M6 x 12 for Bracket	
All models	FS106127ML

RADIATOR FAN & MOTOR ASSEMBLY with Cowl	
All models	PGF101410

NUT Radiator Fan Mounting	
All models without aircon	FN105045
All models with aircon	FN105047

TOP RADIATOR HOSE	
All models	PCH112320

BOTTOM RADIATOR HOSE	
All models	PCH112330

STRIP -rubbing - radiator hose	
bottom side MG TF	PZE000011
top side MG TF	PZE000021

FOAM	
bonnet locking platform MG TF	PZL000010
radiator to bumper armature MG TF	PZL000020

COOLING - ENGINE BAY FAN & FITTINGS MG F (SEP 95 TO FEB 02) & MG TF (FEB 02 ON)

ENGINE BAY FAN ASSEMBLY	
All models	PGG000270

NUT - flange - M6 Engine Bay Fan Mounting	
All models	FN106047

SENSOR - engine bay ambient air	
All models	MHK100520

COOLING - THERMOSTATS MG F (SEP 95 TO FEB 02) & MG TF (FEB 02 ON)

THERMOSTAT 88 Degrees	
MG F	PEL10016

THERMOSTAT HOUSING	
All models Up To 2D600100	PEM10025

THERMOSTAT PRT inc Housing	
All models with PRT system (Retro fit option & fitted as Standard from 2D600101)	PEM101020

COOLANT DISTRIBUTION HOUSING	
Fits in place of the standard thermostat housing on vehicles fitted with PRT system.	
All models with PRT system (Retro fit option & fitted as Standard from 2D600102)	PEM000020

SEAL Thermostat Housing	
All models	PEF10010

COOLING - EXPANSION TANK & HOSES MG F (SEP 95 TO FEB 02) & MG TF (FEB 02 ON)

HOSE ASSEMBLY - heater in/out	
All models -exc VVC	PEH100790
1.8 VVC	PEH100940

VALVE - cooling system bleed	
All models -exc VVC	PEI100010

ADAPTOR - Heater Feed/Return Hose	
All models -exc VVC	PFF100040

HOSE	
expansion tank coolant	
All models to 4D628365	PCH111600
All models from 4D628366 - exc VVC	PCH111600

cooling system bleed	
MG F	PCH112340
MG TF	PCH002500

cooling system bleed - heater/bypass to engine	
MG TF	PCH002490

thermostat to pipe	
All Models	PEH100870

PIPE ASSEMBLY - heater to engine rail	
All Models	PEP103230

SCREW - flanged head	
M8 x 16 for pipe All Models	FS108161

M6 x 16 - expansion tank to body	
All Models	FS106167

TANK - radiator expansion	
All Models	PCF000141

CAP - expansion tank pressure	
All Models	PCD100160

GROMMET - expansion tank locating	
All Models	ATU1040A

SENSOR COOLANT EXPANSION TANK	
MG TF from 4D632424	PCJ000040

COOLANT PIPE ASSEMBLY	
IN STAINLESS STEEL -	
PEP102470SS	

MAIN COOLANT HOSES & PIPES	
MG F (SEP 95 TO FEB 02)	
& MG TF (FEB 02 ON)	

RADIATOR TO ENGINE MAIN UNDERFLOOR	
COOLANT PIPE ASSEMBLY	
All models, manual	PEP102470
All models, automatic	PEP103280

CLIP FOR MAIN COOLANT PIPE ASSY	
MG F up to AD4176	YQR100750

SCREW - M8 x 35 - underfloor pipes to body	
All models	FS108357A

HOSE to pipe-coolant - engine inlet	
All models, manual	PEH100820
All models, automatic up to YD520171	PEH101420
All models, automatic from YD520172	PEH000420

HOSE ASSEMBLY - engine to radiator	
All models	PEH000090

HOSE - heater return coolant	
All models, manual	PEH100850
All models, automatic - exc VVC	PCH000460EVA

HOSE - outlet to pipe coolant	
All models, manual	PEH100900

ADAPTOR - Heater Hose	
All models, manual	PFF100040

HOSE - outlet to pipe coolant - engine inlet	
All models, automatic - exc VVC	PEH101730

HOSE - bypass to heater coolant	
All models - exc VVC	PEH101740

HOSE ASSEMBLY	
heater bypass including restrictor	
All models, manual	PCH002792
top with T Piece All models, manual	PCH002960
bottom with PRT All models, manual	PCH002970
with Thermostat Housing	
All models, automatic from 4D622951	PCH003320

CLIP FOR MAIN COOLANT PIPE ASSY	
MG F up to AD4176	YQR100750

SCREW - M8 x 35 - underfloor pipes to body	
All models	FS108357A

HOSE to pipe-coolant - engine inlet	
All models, manual	PEH100820
All models, automatic up to YD520171	PEH101420
All models, automatic from YD520172	PEH000420

HOSE ASSEMBLY - engine to radiator	
All models	PEH000090

HOSE - heater return coolant	
All models, manual	PEH100850
All models, automatic - exc VVC	PCH000460EVA

HOSE - outlet to pipe coolant	
All models, manual	PEH100900

ADAPTOR - Heater Hose	
All models, manual	PFF100040

HOSE - outlet to pipe coolant - engine inlet	
All models, automatic - exc VVC	PEH101730

HOSE - bypass to heater coolant	
All models - exc VVC	PEH101740

HOSE ASSEMBLY	
heater bypass including restrictor	
All models, manual	PCH002792
top with T Piece All models, manual	PCH002960
bottom with PRT All models, manual	PCH002970
with Thermostat Housing	
All models, automatic from 4D622951	PCH003320

CLIP FOR MAIN COOLANT PIPE ASSY	
MG F up to AD4176	YQR100750

SCREW - M8 x 35 - underfloor pipes to body	
All models	FS108357A

HOSE to pipe-coolant - engine inlet	
All models, manual	PEH100820
All models, automatic up to YD520171	PEH101420
All models, automatic from YD520172	PEH000420

HOSE ASSEMBLY - engine to radiator	
All models	PEH000090



PRICES
SEE PAGES 124-151
OR VISIT OUR
WEBSITE

MG F (SEP 95 TO FEB 02) & MG TF (FEB 02 ON)



MG F & MG TF



HEATER ASSEMBLY
- JEC102220

COOLING - HEATER, VALVE & HOSES MG F (SEP 95 TO FEB 02) & MG TF (FEB 02 ON)

HEATER ASSEMBLY

MG F
MG TF

JEC102220
JEC000940

VALVE ASSEMBLY - coolant engine heater All models

JJB100280

PIPE ASSEMBLY-engine heater All models

PEP102230

SCREW - flanged head - M6 x 10 All models

FS106107

HOSE

heater-inlet All models
inlet heater All models
outlet heater All models

JHB100450
JHB100460
JHC100240

COOLING - GENERAL MG F (SEP 95 TO FEB 02) & MG TF (FEB 02 ON)

TEXACO HAVOLINE XLC (Extended Life Coolant) Antifreeze

1 Litre All models
5 Litres All models

XP1LL
XP5LL

RADIATOR RELIEF Cooling System Additive

946 ml All models

RX1461

HOLTS RADWELD 250ml All models

RX1508

ELECTRICAL - GENERAL MG F (SEP 95 TO FEB 02) & MG TF (FEB 02 ON)

BATTERIES

MG F, power steering, up to WD32999
MG F, manual steering, up to WD32999
All models, from WD33000

ZUA000027E
ZUA000063E
ZUA000027E

BATTERY CONDITIONER KIT, CTEK800, (keeps battery charged during storage) All Models

RX1410CTEK

BATTERY CHARGER - 12 & 6 Volt switchable 11Amp All Models

GAC7106

DIS-CAR-NECT Battery Isolator (fits to battery terminal) All models

RX1356

BATTERY ISOLATOR SWITCH with removable red key (fits into main battery lead) All models

LL1171

TRANSMITTER BATTERIES All models

YWK10003 PAIR

TRANSMITTER All models - exc: Japan

YWX101220A

HORN low note All models

YEB100780

STEBEL AIR HORN

Red All models
Black All models

XPT000005ACA
XPT002100AC

TWIN AIR HORN KIT inc Compressor and fittings All Models

RX1381 MARCO

ELECTRICAL - MAJOR UNITS MG F (SEP 95 TO FEB 02) & MG TF (FEB 02 ON)

ALTERNATOR ASSEMBLY - reconditioned, exchange

All models, manual, up to YD522572,
All models from YD522573

YLE101530E
YLE102430E

STARTER MOTOR - reconditioned, exchange

1.8 manual up to 18K4FJ31365329 or
18K4FJ32380976 exc VVC,
1.8 manual from 18K4FJ31365329 or 18K4FJ32380976
and VVC up to YD522572,
Automatic
Manual and VVC from YD522573,

NAD10042E
NAD10050E
NAD101320E
NAD101340E



ALTERNATOR ASSEMBLY
- YLE102430E

ELECTRICAL - FUSEBOX & RELAYS MG F (SEP 95 TO FEB 02) & MG TF (FEB 02 ON)

FUSEBOX ASSEMBLY

engine compartment

MGF up to XD511058

MGF from XD511059

MG TF

passenger compartment

All models up to 3D610317

YPP100310
YQE103670
YQE000400

RELAY ASSEMBLY engine management normally open

All models up to 3D610317

All models from 3D610318

YPP100290
YWB100970
YWB000440

RELAY

Air conditioning All models from 4D620549

Yellow - heated rear window All models

Yellow - front fog lamp All models

Normally open - fuel pump All models

YWB000440
YWB10012L
YWB10012L
YWB000440

CONTROL UNIT electric window lift-one touch -

A post lower

All models from XD511059 up to 4D620548

YWC106170

RELAY in passenger compartment fusebox

MGF up to AD5654

DJP8473

CONTROL UNIT multi function in passenger

compartment fusebox All models

YWC104500

FLASHER UNIT electronic in passenger

compartment fusebox MGF up to AD5654

YWT10003

ELECTRICAL - CONTROL UNITS MG F (SEP 95 TO FEB 02) & MG TF (FEB 02 ON)

ECU - exchange

All models up to YD522572 -exc VVC

Manual ABS and Automatic models

from YD522573 up to 4D639328

from 4D639329

Manual non ABS models from YD522573

1.8 VVC models from YD522573

Trophy/ MG TF160

MKC104112E

NNN100783
NNN100743
NNN000060
NNN000100
NNN000160

ELECTRICAL - ENGINE SENSORS MG F (SEP 95 TO FEB 02) & MG TF (FEB 02 ON)

SENSOR

crank engine - Lucas All models

oxygen multi point injection

All models up to YD522572

pre & post catalyst

All models from YD522573

NSC100760

MHK10006

MHK100840

SCREW

flanged head - 10mm, M5 sensor fixing

All models

M5 x 16 - crank sensor fixing All models

FS105165

FS105167

TRANSDUCER COOLANT TEMPERATURE

Brown All models up to YD522572

All models from YD522573

Black - for gauge All models

MEK100060

MEK000030

YCB100420

WASHER - sealing - transducer All models

MDY100040L

SENSOR

air inlet temperature engine-electric control unit

All models

over temperature warning catalyst

Japan only up to WD40179

coolant temperature All models - exc VVC

NNK10001

NSC100320

GTR185

TRANSDUCER OIL TEMPERATURE

170 degrees C

1.8 from AD1018 up to 18K4FJ31646501 or

18K4FJ32646201 - exc VVC

1.8 VVC models up to 18K4KJ89636256 or

18K4KJ90618894

All models from XD511059

YCB100290

YCB100290

MEK100160

SWITCH - oil pressure engine

1.8 up to 18K4FJ31646501 or

18K4FJ32646201 - exc VVC

Brown All models from 18K4FJ31646502 or

18K4FJ32646202 - exc VVC

1.8 WC models up to 18K4KJ89636256 or 1

8K4KJ90618894

Brown 1.8 VVC models from 18K4KJ89636257 or

18K4KJ90618895

NUC10003

NUC100280

NUC10003

NUC100280

WASHER - sealing - oil pressure switch

1.8 VVC models from 18K4KJ89636257 or

18K4KJ90618895

MDY100080

SENSOR

multi point injection manifold pressure

All models - exc VVC

1.8 VVC models

up to YD522572

from YD522573

multi point injection ambient air - heater rail

All models

INSERT - screw in for sensor All models

NUT for insert All models

SENSOR - camshaft engine All models - exc VVC

O RING - camshaft sensor All models - exc VVC

SENSOR

camshaft engine - short pin

1.8 VVC models up to YD522572

1.8 VVC models from YD522573

air inlet temperature engine - electric control unit

1.8 VVC Models

MHK100820

MHK100600

MHK100820

MHK100520

LZN10001

JRC3106

NSC100932

TGN100050

NSC100380

NSC000010

NNK10001

ELECTRICAL - IGNITION SYSTEM MG F (SEP 95 TO FEB 02) & MG TF (FEB 02 ON)

SPARK PLUGS Champion Long Life All models

NLP100290

DISTRIBUTOR CAPS

All models up to YD522572 - exc VVC

NJD10010

ROTOR ARMS

All models up to YD522572 - exc VVC

NJE100070

HT LEAD SETS

All models,

up to YD522572 - exc: VVC

from YD522573 and Automatic - exc: VVC

1.8 VVC up to YD522572

1.8 VVC from YD522573

Lumenition Uprated inc coil lead

All models, up to YD522572 - exc: VVC

NGC000090

NGC000040

NGC000070

NGC000030

RP1037K

COILS

All models,

up to YD522572 -exc: VVC

from YD522573 and Automatic - exc: VVC

1.8 VVC up to YD522572

1.8 VVC from YD522573

NEC100630

NEC000120

NEC100690

NEC000130

ELECTRICAL - FASCIA SWITCHES MG F (SEP 95 TO FEB 02) & MG TF (FEB 02 ON)

SWITCHES

Hazard - Black MGF up to XD511058

Heated Rear Window

MG F up to XD511058

All models from XD511059

YUG101900PMP

YUG101480PMA

YUG102570PMP

FOG

Front

MG F up to XD511058

All models from XD511059

YUG101470PMA

YUG102590PMP

Rear

MG F up to XD511058

All models from XD511059

YUG101830PMA

YUG102740PMP



MG F (SEP 95 TO FEB 02) & MG TF (FEB 02 ON)

PRICES
SEE PAGES 124-151
OR VISIT OUR
WEBSITE



ELECTRICAL

WARNING & COURTESY SWITCHES
MG F (SEP 95 TO FEB 02) & MG TF (FEB 02 ON)

STOP LAMP

All models up to YD514325 **XKB100080**
All models from YD514326 **XKB10003**

GLOVEBOX LAMP

All models **YUE10005**

FUEL SYSTEM - ENGINE CONTROLS

MG F (SEP 95 TO FEB 02) & MG TF (FEB 02 ON)

PEDAL & BRACKET ASSEMBLY ACCELERATOR

All models, RHD **SAB101162PMP**
All models, LHD **SAB101172PMP**

CABLE ASSEMBLY ACCELERATOR

All models, RHD **SBB000280**
All models, LHD **SBB000290**

SWITCH - Inertia, fuel pump

All models **WQT100030**

FUEL SYSTEM - TANK & FITTINGS

MG F (SEP 95 TO FEB 02) & MG TF (FEB 02 ON)

TANK & PUMP ASSEMBLY

All models **WFE107371**

STRAP ASSEMBLY FUEL TANK

All models **WFS100201**

PIPE ASSEMBLY - Vent-Fuel Tank

All models **WFP000120**

PIPE fuel filler neck - restricted

All models up to YD522572 -exc Japan **WLP103170**
All models from YD522573 -exc Japan **WLP103422**

FUEL FILLER CAP

specific key number
All models up to YD522572 **WLD100490H**
All models from YD522573 **WLD100710H**

FUEL PUMP AND SENDER UNIT

All models, up to YD522572 **WFX100670**
All models, from YD522573 up to 4D634733 **WFX101320**
All models, from 4D634734 **WFX101321**

RING RETAINING FUEL PUMP

All models, up to YD522572 **NTC5858**
All models from YD522573 **WFG100111**

SEAL FUEL PUMP UNIT

All models, up to YD522572 **NTC5859**
All models from YD522573 **ESR3806A**

FUEL SYSTEM - INJECTORS & REGULATORS

MG F (SEP 95 TO FEB 02) & MG TF (FEB 02 ON)

FUEL INJECTOR

All models, up to YD522572, manual **MJY100430**
All models from YD522573 - exc VVC **MJY100640**
VVC models from YD522573 **MJY100580**

FUEL PRESSURE REGULATOR

All models **MKW10016**
Upated, Adjustable All models **RP1031**

FUEL SYSTEM - FILTERS & FITTINGS

MG F (SEP 95 TO FEB 02) & MG TF (FEB 02 ON)

AIR FILTER

All models, up to YD522572 **PHE100421**
All models, from YD522573 **PHE100540**

K&N REPLACEMENT ELEMENT AIR FILTER

All models **PHE100421K-N**

K&N 57i INDUCTION KIT

MG F **RP1026**
MG TF **RP1027**

FUEL FILTER

All models **WJN101191**

THROTTLE BODY

48mm Alloy version
1.8 and 1.6 from YD522573 **MHB000080**
1.6 Manual to YD522572 **MHB000090**
52mm Alloy version 1.8 VVC **MHB000261**
(will fit other models as a performance upgrade)

THROTTLE BODY O RING & STEPPER MOTOR KIT

All models **MKG100250**

SCREW - flanged head - M6 x 25 -

throttle body to inlet manifold All models **FS106255L**

THROTTLE BODY POTENTIOMETER

All models **SLD100080**

STEPPER MOTOR

All models **MDQ100170**

SCREW - Stepper Motor

All models, up to YD522572 **MYP100340**
All models, from YD522573 **MYP100610**

HOSE - moulded-vent fuel system -

throttle body to stepper motor **MAH100840**
All models, up to YD522572 **MAH101070**
All models, from YD522573

EXHAUST SYSTEM - DOWNPIPES

MG F (SEP 95 TO FEB 02) & MG TF (FEB 02 ON)

DOWNPIPE

All models, - exc: Trophy **WCD106000**
manual, up to YD522572 **WCD106091**
manual, from YD522573 **WCD000280**
auto., from YD522573 **WCD000390**

GASKET - manifold to downpipe

All models up to YD522572 **WCM10009**

GASKET - manifold to downpipe

All models from YD522573 **WCM100600**

STUD - M10 x 25 - manifold to downpipe

All models **TE110051**

NUT - flange - M10 - manifold to downpipe

All models **ESR2034**

RUBBER MOUNTING on downpipe

All models **DBP7104**

GASKET - downpipe to catalyst

All models **WCM100480**

EXHAUST SYSTEM - CATALYTIC CONVERTERS

MG F (SEP 95 TO FEB 02) & MG TF (FEB 02 ON)

CATALYTIC CONVERTER

All models, up to WD40179 -
exc: Japan **WAG103650SLP**
Japan only **WAG103660SLP**
All models, **WAG103650SLP**
from WD40180 up to YD522572 **WAG104640**
from YD522573 to 3D618111 **WAG000070**
Trophy, from YD530689 to 3D618111 **WAG103660SLP**
All models, Japan, up to WD40179 **WAG000670**
All models, from 3D618112

GASKET - catalyst to rear assembly

All models **WCM100480**

EXHAUST SYSTEM - REAR ASSEMBLIES

MG F (SEP 95 TO FEB 02) & MG TF (FEB 02 ON)

REAR ASSEMBLY

MG F, up to AD12534 - exc: Japan **WCE103450SLP**
MG F, from AD12535 up to YD522572 -
exc: Japan **WCE103780SLP**
MG F, from YD522573 - exc: Trophy **WCG103100SLP**
Trophy, oval tailpipe, from YD522573 **WCE103780SLP**
Trophy, round tailpipe, from YD530689 -
exc: sports option **WCG000550**
1.6 MG TF Petrol **WCG000460**
1.8 MG TF Petrol - VVC **WCG000550**
1.8 MG TF Petrol - exc: VVC **WCG000460**

FINISHER - trim exhaust tailpipe - (kit exhaust repair)

48mm diameter MG F **WDV100130**
35mm Diameter MG TF **DUB000130**

BRACKET ASSEMBLY around rear assembly

All models to AD12534 -exc Trophy **WCU100870**

BRACKET - mounting intermediate

All models **WCU100760**

BRACKET ASSEMBLY - mounting rear exhaust

All models **WDB100040**

MOUNTING - rubber exhaust system

All models **WCS100090**

SCREW - M8 x 35 for bracket

All models **FS108357A**

FLANGE NUT - M8 for bracket

All models **FN108041**

EXHAUST SYSTEM - PERFORMANCE

MG F (SEP 95 TO FEB 02) & MG TF (FEB 02 ON)

4-2-1 S/S EXHAUST MANIFOLD

MG F & TF 1.8 inc. VVC **RP1054**

LINK PIPE

MG F & TF 1.8 inc. VVC **RP1055**

SPORTS CATALYTIC CONVERTER

MG F 9/95- 2/02 1.8 inc. VVC **RP1056**

MG TF 2/02 ON 1.8 inc. VVC **RP1057**

CATALYTIC CONVERTER REPLACEMENT PIPE

MG F 9/95-2/02 1.8 inc. VVC **RP1058**

PERFORMANCE EXHAUST SILENCER

Stainless Steel, Twin Round Exits **XPT000039ACB**

ELBOW JOINT

Stainless Steel, required to fit Performance exhaust **XPT000039ACA**

GASKET, required to fit Performance exhaust

MG F up to YD522572 **WCM100480**

EXHAUST SYSTEM - GENERAL

MG F (SEP 95 TO FEB 02) & MG TF (FEB 02 ON)

COOL IT THERMO-TEC EXHAUST INSULATING WRAP

2" x 50' All Models **RX1382**

COOL IT THERMO-TEC EXHAUST INSULATING WRAP

INSTALLATION STRAP KIT All Models **RX1383**

HY-COTE EXHAUST PAINT

Aerosol Black 400ml All Models **RX1432A**

LIGHTING - LAMPS

MG F (SEP 95 TO FEB 02) & MG TF (FEB 02 ON)

HEADLAMPS

RHD vehicles **XBC104020**
MG F, RH - exc: Trophy **XBC104030**
MG F, LH - exc: Trophy **XBC002500**
MG TF, RH **XBC002510**
MG TF, LH **XBC000520**
Trophy, RH **XBC000530**
Trophy, LH
LHD vehicles **XBC104040**
MG F, RH - exc: Trophy **XBC104050**
MG F, LH - exc: Trophy **XBC002520**
MG TF, RH **XBC002530**
MG TF, LH **XBC000540**
Trophy, RH **XBC000550**
Trophy, LH

HEADLAMP LENS

MG F, RH - exc: Trophy **XBQ100700**
MG F, LH, - exc: Trophy **XBQ100710**

FRONT FOG LAMPS

MG F, RH **XBJ100260**
MG F, LH **XBJ00270**
MG TF, RH **XBJ105500**
MGTF, LH **XBJ105510**

INDICATOR LAMPS

MG F, RH, up to XD511058 (orange) **XBD100640**
MG F, RH, from XD511059 (clear) **XBD101020**
MG F, LH, up to XD511058 (orange) **XBD100650**
MG F, LH, from XD511059 (clear) **XBD101030**

SIDE REPEATER LAMPS

MG F up to XD511058 (orange) **AHU2592**
MG F from XD511059 and MG TF (clear) **XGB000060A**

CLEAR SIDE REPEATER CONVERSION KIT

RP1042

REAR LAMPS

MG F, RH **XFB101600**
MG F, LH **XFB101610**
MG TF, RH (can retro fit to MG F) **XFB000540**
MG TF, LH (can retro fit to MG F) **XFB000550**

REAR LAMPS GASKET

All models **XFH100440**

HIGH MOUNTED REAR STOP LAMP

Conversion Kit (for early MG F without HMSL) **XFN100180**
Bulb type MG F (inc surround) **XFG100230**
LED type MG TF **XFG000050**

GASKET, Stop Lamp, All models

CKE100820

REAR NUMBER PLATE LAMP

XFC000200

INTERIOR LAMPS

Glovebox and Footwell Lamp **ADU2066L**
Trunk and Load Space Lamp **XDE000300**



REAR ASSEMBLY - WCE103780



PRICES
SEE PAGES 124-151
OR VISIT OUR
WEBSITE

MG F (SEP 95 TO FEB 02) & MG TF (FEB 02 ON)



LIGHTING - BULBS

MG F (SEP 95 TO FEB 02) & MG TF (FEB 02 ON)

HEADLAMP BULBS

Main beam	
MG F/TF, h1-55 Watt	GLB448
MG F/TF, h1-55 Watt Xenon, Pair	GLB448 SILVER
Capless side lamp	
MG F/TF, bulb-501, w10/5-5 Watt	AFU4481
Main beam - MG TF, HB3-60 Watt	XZQ000140
Dip beam - MG TF, h7-55 Watt	XZQ000210
Dip beam - MG TF, h7-55 Watt, Xenon,	GLB499 SILVER
Halogen fog - MGTf, h11-55w	XLQ000110

INDICATOR LAMP BULBS

Clear - Bulb-382, p25/1-21 Watt, up to XD511058	GLB382
Amber, direction indicator - bulb-344, 21 Watt, from XD511059	XZQ100190L
Capless - side repeater, bulb-501, Clear, w10/5-5 Watt	AFU4481
Amber, wy5 Watt, from XD511059	XZQ100210L

REAR LAMP BULBS

Brake light, clear - bulb-382, p25/1-21 Watt	GLB382
Tail light, r19-55 Watt	GLB207
Indicator light, amber bulb-344, 21 Watt	XZQ100190L
Reversing light, clear - bulb-382, p25/1-21 Watt	GLB382
Fog lamp, clear - bulb-382, p25/1-21 Watt	GLB382
High level stop lamp - bulb	XZQ100200
Number Plate Lamp - bulb	GLB239

INTERIOR LAMP BULBS

Glovebox and Footwell Lamp - bulb	GLB239
Luggage Space Lamp - bulb	GLB245

WINDSCREEN WASHERS & FITTINGS - BULBS

MG F (SEP 95 TO FEB 02) & MG TF (FEB 02 ON)

CONTAINER ASSEMBLY - windscreen wash

All models ADU3906

CAP - container All models

DMG10001

GROMMET - pump to container assembly

All models BAU2043A

PUMP ASSEMBLY - windscreen wash

All models DMC100380

WASHER JET All models

DNJ000380

HEATED WASHER JET CONVERSION KIT

All models VUB100220

GASKET - windscreen wash jet assembly

All models DNK10002

HOSE - wash system - 4mm bore x 5 Mtr roll

All models DNH000150BLA

CONNECTOR

wash system tee piece All models DNG10010

wash system elbow All models DNG10013

VALVE - wash system non return All models

AMR6676

SCREENWASH 1 Litre All models

RX1535

MOTOR & BRACKET ASSEMBLY - windscreen wiper

All models up to YD514325 DLB000260

All models from YD514326 DLB000270

MECHANISM-WINDSCREEN WIPER All models

RHD DKD100450

LHD DKD100440

WIPER MECHANISM REPAIR KIT All models

Standard DKT000010

Up-rated (with metal ball joints) DKT000010UR

BLADE

Drivers

All models, RHD - ex Australia

Australia

All models LHD

Passengers

All models, - ex Australia

Australia

All models LHD

WIPER ARM

Drivers

All models RHD - ex Australia

Australia

Passengers

All models RHD - ex Australia

Australia

All models LHD

DKB102030

DKB102540

DKB102040

DKB102550

DKB102060



STEERING - RACK & FITTINGS

MG F (SEP 95 TO FEB 02) & MG TF (FEB 02 ON)

STEERING RACKS - Exchange

MGF with Manual Steering, RHD

Reconditioned

QAB102300E

MGF with PAS, RHD

Reconditioned

QAB102320E

MG F with PAS, LHD

New

QAB102330

Reconditioned

QAB102330E

MGTf with PAS, RHD

New

QAB000240

Reconditioned

QAB000240E

MG TF with PAS, LHD

New

QAB000250

Reconditioned

QAB000250E

STEERING RACK GAITER KIT All models

QBZ10001

TRACK ROD ENDS All models

QJB100140

LOCKNUT

M10 on Track Rod End All models

GHF233

on Rack MGF with Manual Steering, RHD

DCP3625

PAD - insulation - rack mounting All models

NAM3557

CLAMP - rack mounting All models

FAM4752

U-BOLT Rack Mounting All models

GHF252

NUT for U-bolt Nyloc - M8 All models



STEERING - COLUMN & FITTINGS

MG F (SEP 95 TO FEB 02) & MG TF (FEB 02 ON)

COLUMN ASSEMBLY

MGF with Manual Steering

QMB100910

All models with PAS up to XD511058

QMB101570

All models with PAS from XD511059

QMB102270PMP

SHAFT - lower-collapse steering column

All models RHD up to WD40302

QMN100300

All models RHD from WD40303

QMN100182

All models LHD up to WD40302

QMN100310

All models LHD from WD40303

QMN100192

BOLT - nylon-patch - intermediate shaft upper and lower

QYG10016

LOCK ASSEMBLY - steering column - non-specific key number, illuminated

MGF RHD

QRF101080

MGF LHD

QRF101090

BOLT - shear - lock steering column All models

QRH10001

QYG10016

QRF101080

QRF101090

QRH10001

WIPER MECHANISM UPATED REPAIR KIT - DKT000010UR

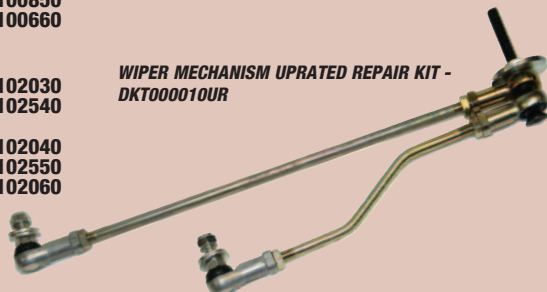

STEERING - CONTROL UNITS

MG F (SEP 95 TO FEB 02) & MG TF (FEB 02 ON)

CONTROL UNIT POWER ASSISTED STEERING

MG F up to XD511058 YWC103773

MG F from XD511059 YWC106740

MG TF YWC000720

FRONT SUSPENSION - LOWER

MG F (SEP 95 TO FEB 02) & MG TF (FEB 02 ON)

LOWER ARM ASSEMBLY

MG F RH - exc Trophy RBJ101060

MG F LH - exc Trophy RBJ101070

Trophy RH RBJ000220

Trophy LH RBJ000230

MG TF RH RBJ000740

MG TF LH RBJ000750

BALL JOINTS All models

RH RBK100400

LH RBK100410

BUSH All models

front RBX10025

rear RBX000770

BOLT - nylon-patch - front/rear suspension arm to subframe

All models RYG10048

FRONT SUSPENSION - ANTI ROLL BAR & FITTINGS

MG F (SEP 95 TO FEB 02) & MG TF (FEB 02 ON)

BAR

MG F RBL100631

MG TF up to 3D617816 RBL000230

MG TF, from 3D617817 RBL000171

LINK ASSEMBLY All models,

RH, up to 3D617816 RBM100101

LH, up to 3D617816 RBM100111

MG TF, RH, from 3D617817 RBM000170

MG TF, LH, from 3D617817 RBM000171

BOLT - M10 x 55 link to bar All models

FN110041

NUT - M10 link to bar All models

BUSH - roll bar mounting All models

CLAMP BRACKET All models

SCREW - clamp bracket All models

FRONT SUSPENSION - UPPER

MG F (SEP 95 TO FEB 02) & MG TF (FEB 02 ON)

UPPER ARM ASSEMBLY

MG F RH RBJ101200

MG F LH RBJ101210

MG TF RH RBJ000840

MG TF LH RBJ000850

BALL JOINTS

MG F RBG000020SLP

MG TF RBK000100

SHAFT - Arm Pivot MG F up to YD532349

2A4325

UPPER ARM FULCRUM SHAFT REPAIR KIT

MG F up to YD532349 2A4325KP

SHAFT - Arm Pivot All models from YD532350

RBR000020

BEARING - needle roller

MG F 88G302

MG TF 2A3497

NIPPLE - grease All models

LN10081

WASHER - thrust - outer All models

RDB000010

SEAL - front/rear All models

RYX000030

WASHER - sealing - outer All models

FAM9267

NUT on Pivot Shaft All models

NV608041

PLATE Pivot Shaft All models

2A4327

COLLAR Pivot Shaft All models

FAM7789

SCREW - flanged head - M6 x 16 All models

FS106167

WASHER - plain - M12 All models

WA112081

NUT - M6 All models

FX106041

SCREW - plate to tower All models

RYP10001



MG F (SEP 95 TO FEB 02) & MG TF (FEB 02 ON)

PRICES
SEE PAGES 124-151
OR VISIT OUR
WEBSITE



FRONT SUSPENSION -

DAMPER & FITTINGS

MG F (SEP 95 TO FEB 02) & MG TF (FEB 02 ON)

SHOCK ABSORBER

MG F RNB000260
MG TF, standard/CVT up to 5D639630 RNB000880
MG TF, from 5D639631 -
exc: sports suspension RNB001210
MG TF, sports suspension - exc: Australia RNB000890
MG TF, Australia only RNB000891
MG TF, sports suspension, Australia only RNB000891

SHOCK ABSORBERS, Pairs

Gaz Adjustable MG F RP1023GAZ
Spax Adjustable MG F RP1023SPAX
Koni Adjustable MG F RP1023KONIFRONT
Spax Adjustable MG F RP1024

HYDRAGAS UNITS

MG F - exc Trophy RNK100070
Trophy RNK000010

SUSPENSION KNUCKLE MG F

RGG001219EVA

SPRING - suspension knuckle joint MG F

NAM9013

SPACER

2.3mm - suspension knuckle joint MG F RPL100080

REBOUND BUFFER MG F

2A4267SLP

SCREW - rebound buffer MG F

PX505

CLIP - spring steel - bump stop MG F

RBZ10001

BUMP STOP - On Damper MG TF

RNH000140

COIL SPRING

MG TF up to 5D639630 REB000670
MG TF from 5D639631 REB001220

RETAINER - spring MG TF

RNC000021

SEAT - spring front MG TF

RNG000020

MOUNTING - rubber - cushion MG TF

RNF10090L

BOLT - damper lower mounting MG F

FB110221L

SPACER MG F

RNG10001

WASHER - cup - between damper bush

and upper arm MG F NAM1290
and nut MG F RYF100430

NUT MG F

GHF233

BOLT - damper lower mounting MG TF

RYG000400

TRANSMISSION & DRIVE SHAFTS

MG F (SEP 95 TO FEB 02) & MG TF (FEB 02 ON)

DIFFERENTIAL - Limited Slip MG F

RP1044

SHAFT & JOINT ASSEMBLY INNER All models,

Manual, RH TDC100630
Manual, LH TDC100640
Automatic, RH - exc VVC TDC000100

CV JOINTS All models

without Anti Lock Brakes (exchange) TFP000080E
with Anti lock Brakes (exchange) TFB000150E

DRIVE SHAFT GAITER KIT

inner All models TDR000200
outer All models TDR000190

DYNAMIC DAMPER DRIVESHAFT KIT

RH All models TDF10015

RING - snap - drive shaft to differential All models,

Manual, ADU8050
Automatic, - exc VVC TDL10008

DRIVE FLANGE - Hub All Models

RUB000150

REAR SUSPENSION - LOWER

MG F (SEP 95 TO FEB 02) & MG TF (FEB 02 ON)

ARM ASSEMBLY MG F

RGG103680

BOLT - nylon-patch - arm assy & track control link to s/frame MG F

RYG10048

BUSH - lower arm inner MG F

RBX10025

WASHER - plain - lower arm MG F

WJ112001L

BUSH - transverse link hub MG F

RGX100470

BOLT - adhesive-patch - lower arm to hub MG F

RYG100820

BUSH - tie rod mounting large MG F

RGX100480

WASHER - plain-thick

rear, 2.50mm MG F RYF100250
front, 3.50mm MG F RYF100260

NUT - flange - M12 MG F

FX112057

TRACK CONTROL LINK MG F

RGZ100050

LOCKNUT - Track Control Link MG F

NY210041

BAR ASSEMBLY - tie-bent MG F

RGB100540

BOLT - flanged head - M12 x 80 top link MG F

FC112161

ARM ASSEMBLY

MG TF RH RGG000243
MG TF LH RGG000253

BOLT - lower trailing arm

MG TF up to 4D630350 RYG000410
MG TF from 4D630351 RYG000411

LINK ASSEMBLY TOP

MG TF up to 4D620745 RGD000571
MG TF from 4D620746 RGD000570

TRACK CONTROL LINK

MG TF RH RGD000620
MG TF LH RGD000630

BOLT - torx-pan - M10 x 65 Track Control Link

MG TF RHT000020

BOLT - flanged head - M12 x 90

Arm to Compliance Bracket MG TF FC112187A

REAR SUSPENSION

ANTI ROLL BAR & FITTINGS

MG F (SEP 95 TO FEB 02) & MG TF (FEB 02 ON)

ANTI ROLL BAR

MG F RGB100361
MG TF RGB000291

LINK ASSEMBLY

MG F RGD100180
MG TF RH RGD000660
MG TF LH RGD000670

BOLT - M10 x 50 link to bar All models

FB110101

NUT - M10 link to bar/arm All models

FN110041

BOLT - M10 x 45 link to arm MG TF

FB110091

BUSH - roll bar mounting All models

RGX10006

CLAMP BRACKET All models

EGP1714

NUT - flange - M8 - clamp bracket All models

FN108041

REAR SUSPENSION - UPPER

MG F (SEP 95 TO FEB 02) & MG TF (FEB 02 ON)

ARM ASSEMBLY

MG F RH RBJ101200
MG F LH RBJ101210
MG TF RH RGD000920
MG TF LH RGD000930

UPPER ARM FULCRUM SHAFT REPAIR KIT

MG F up to YD532349 2A4325
MG F from YD532350 RBR000020

BEARING - needle roller MG F

2A4325KP 88G302

NIPPLE - grease MG F

LN10081

COLLAR MG F

FAM7789

WASHER - thrust - outer MG F

RDB000010

SEAL - front/rear suspension arm MG F

RYX000030

WASHER - sealing - outer MG F

FAM9267

NUT on Pivot Shaft MG F

NV608041

BOLT - M12 x 160 Arm Pivot MG TF

BH112321

WASHER - plain - M12 MG TF

WA112081

LOCKNUT - upper arm pivot bolt MG TF

NY112041

SPACER - upper arm pivot MG TF

RLM000021

FLANGED SPACER - upper arm pivot MG TF

RLM000011

PLATE RETAINING All models

2A4327

SCREW - flanged head - M6 x 16 plate retaining

All models FS106167

NUT - M6 plate retaining All models

FX106041

BALL JOINTS

MG F RBG000020SLP
MG TF RBK000090

REAR SUSPENSION -

DAMPER & FITTINGS

MG F (SEP 95 TO FEB 02) & MG TF (FEB 02 ON)

SHOCK ABSORBER

MG F RPD000180
MG TF, standard/CVT up to 5D639630 RPD000610
MG TF, from 5D639631 -
exc: sports suspension RPD000730
MG TF, sports suspension RPD000620

SHOCK ABSORBERS, Pairs

Gaz Adjustable MG F RP1023GAZ
Spax Adjustable Pair MG F RP1023SPAX
Koni Adjustable Pair MG F RP1023KONIREAR
Spax Adjustable Pair MG TF RP1025

HYDRAGAS UNITS

MG F - exc Trophy RPJ100020
Trophy RPJ000010

SUSPENSION KNUCKLE MG F

Front and Rear RGG001219EVA
SPRING - suspension knuckle joint MG F NAM9013

SPACER

2.3mm - suspension knuckle joint MG F RPL100080

MOUNTING BRACKET & BUSHES KIT - shock absorber

MG F RPM100090

BOLT - damper lower mounting MG F

FB110221L

BUSH - Damper MG F

NAM9017

SPACER MG F

RNG10001

WASHER - cup - between damper bush

and upper arm MG F NAM1290
and nut MG F RYF100430

NUT MG F

GHF233

REBOUND BUFFER MG F

2A4267SLP

SCREW - rebound buffer MG F

PX505

BUMP STOP Trophy

RNV000020

CLIP - spring steel - bump stop MG F

RBZ10001

BUMP STOP - On Damper

MG TF up to 5D639630 RNH000140
MG TF, from 5D639631 RNH000180

COIL SPRING

MG TF up to 5D639630 RKB000520
MG TF, from 5D639631 RKB000880

RETAINER - spring MG TF

RNC000021

BOLT - damper lower mounting MG TF

RYG000400

SUSPENSION - GENERAL

MG F (SEP 95 TO FEB 02) & MG TF (FEB 02 ON)

BUSH KIT - Polyurethane

Front MG F RP1046
Rear MG F RP1047

Front & Rear MG F

Front MG TF RP1046TF
Rear MG TF RP1047TF

Front & Rear MG TF

RP1048TF

SHOCK ABSORBER KIT UPDATED - Front & Rear

MG F RP1171
MG TF RP1172

EIBACH UPDATED SPRING KIT - Front & Rear

MG TF RP1173

EIBACH UPDATED SPRING & SPAX SHOCK KIT

Front & Rear MG TF RP1174

BILSTEIN 'COMFORT' HANDLING PACK - Front & Rear

MG TF RP1175

SUBFRAME & FITTINGS

MG F (SEP 95 TO FEB 02) & MG TF (FEB 02 ON)

SUBFRAME

Front MG F KGB100891
Rear MG F KHB100922

Front MG TF

KGB000160

Rear MG TF

KHB000070

MOUNTING RUBBER

MGF up to WD26658 - exc Trophy KGE10001
MGF from WD26659 - exc Trophy FAM9525
MGF from WD26659 - exc Trophy KGE100150
Trophy KGE000110
MG TF KGE000071
Small Upper Rear All models KKF000040





PRICES
SEE PAGES 124-151
OR VISIT OUR
WEBSITE

MG F (SEP 95 TO FEB 02) & MG TF (FEB 02 ON)



MG F & MG TF

COLLISION PARTS - FRONT MG F (SEP 95 TO FEB 02) & MG TF (FEB 02 ON)

BONNET LOCKING PLATFORM All models	ABG460100
BONNET LATCH All models	FPS10007
BONNET STRIKER AND SAFETY CATCH All models	FPB100110
BONNET STAY All models	BKD100141
GROMMET Bonnet Stay All models	AFU4001
CLIP Bonnet Stay All models	BKG38001
BUMPER MG F MGTF	DPC101450LML DPC000771LML
BUMPER ARMATURE MG F MGTF	DPE100430 DPE100431
CROSS MEMBER ASSEMBLY , Lower All models - exc Trophy	ABC460100
SPARE WHEEL BULKHEAD SECTION MG F to YD522572 -exc Trophy MG TF	ABB460030 ABB460070 ABB460050
BULKHEAD ASSEMBLY Complete MGTF	
HEADLAMP MOUNTING PANEL MG F, RH MG F, LH MGTF, RH MGTF, LH	ABH460020 ABH460030 ABH460101 ABH460111
BRACKET ASSEMBLY , front side member All models - exc: Trophy	ABU460330
BRACKET , side member subframe All models, RH - exc: Trophy All models, LH - exc: Trophy	ABU460160 ABU460170
FRONT WING All models, RH All models, LH	ASB460021 ASB460031
WHEELARCH LINER MG F RH MG F LH MG TF RH MG TF LH	CLF000360 CLF000370 CLF000480 CLF000490
GRILLES MG F, upper, black MG F, upper, bright, up to XD511058 MG F, upper, chrome, from XD511059 MG F, lower, black MG F, lower, bright, up to XD511058 MG F, lower, chrome, from XD511059 MGTF, lower, black MGTF, lower, bright	DQY100200PMD DQY100390MMM DQY100500MMM DQY100210PMD DQY100400MMM DQY100510MMM DQY000100PMD DQY000110MMM



COLLISION PARTS - SIDE MG F (SEP 95 TO FEB 02) & MG TF (FEB 02 ON)

DOOR All models RH All models LH	BDA460120 BDA460130
DOOR SKIN All models RH All models LH	BDA460041 BDA460051
BODY SIDE SILL ASSEMBLY MG F RH MG F LH	ALA460060 ALA460070
SILL PANEL ONLY MG F RH MG F LH	ALG460040 ALG460050
REAR WING MG F RH MG F LH - exc Trophy Trophy	ALH460080 ALH460090 ALH460040
BODY SIDE SILL & WING ASSEMBLY MG TF RH MG TF LH	ALA460120 ALA460130

COLLISION PARTS - REAR MG F (SEP 95 TO FEB 02) & MG TF (FEB 02 ON)

BUMPER MG F MGTF	DQC101150LML DQB000961LML
BUMPER GRILLE MGTF black chrome	DQY000120PMD DQY000130MMM
COMPLETE REAR PANEL ASSEMBLY All models,	AQA460020
CENTRE SECTION of Outer Panel All models,	AQA460050
LAMP MOUNTING PANEL All models, RH LH	AQV460020 AQV460030
UPPER SECTION OF REAR PANEL All models	AQR460080
REINFORCEMENT for Striker All models,	AQR460060
BOOTLID MG F - exc Trophy MG TF	BMD460010 BMD460070
BOOTLID LATCH All models	FQU100230

COLLISION PARTS - GLASS MG F (SEP 95 TO FEB 02) & MG TF (FEB 02 ON)

DOOR GLASS Tinted All models from AD2965, RH All models from AD2965, LH	CUB000440 CUB000450
DOOR GLASS REGULATOR All models from WD30081 All models from WD30081	CUH000400 CUH000410
DOOR GLASS STOP MG F from AD16434 to WD37077 All models from WD37078	CUQ100102 CUQ100140
WINDSCREEN Tinted complete with finisher All models	CMB000610
WINDSCREEN BONDING KIT All models	RTC2063

COLLISION PARTS - MIRRORS MG F (SEP 95 TO FEB 02) & MG TF (FEB 02 ON)

MIRROR ASSEMBLY - interior dipping All models	CTB100100
SLUG - windscreen mirror fixing MG F to WD24000	EDP5642
GLASS ASSEMBLY - exterior mirror - heated, convex All models - exc Australia with Electric Control Mirrors with Manual Control Mirrors	CRD100370 CRD100360

COLLISION PARTS - BADGES MG F (SEP 95 TO FEB 02) & MG TF (FEB 02 ON)

FRONT MG BADGE MG F to 1D529867 MG F from 1D529868 MG TF	DAB101370 DAB101720 DAB000160
REAR MG BADGE MG F MG TF	DAB101710 DAB000160
UNION & CHEQUERED FLAG BADGE MG F MG TF	DAG000070MMM DAG000130MMM

HOOD & FRAME ASSEMBLY MG F (SEP 95 TO FEB 02) & MG TF (FEB 02 ON)

CLASSIC HOOD with soft backlight - exchange All models	DSB100220PDA-E DSB100220RIN-E DSB100220HWP-E DSB100220LZD-E DSB100220CCV-E DSB100220SBT-E DSB100220LFM-E DSB100220CVG-E
black	
black	
green	
grey	
burgundy 80th Anniversary	
tan	
dark grey	
burgundy 75th Anniversary	
with heated glass backlight - exchange All models	XPT000173PMA-E XPT000173RIO-E XPT000173HWP-E XPT000173JZP-E XPT000173LZD-E
black	
beige	
green	
blue	
grey	
X-POWER SPORTSTER HOOD with heated glass backlight - exchange All models	XPT000174PMA-E XPT000174RIO-E XPT000174HWP-E XPT000174JZP-E XPT000174LZD-E XPT000174CVG-E
black	
beige	
green	
blue	
grey	
burgundy	
POWER HOOD CONVERSION KIT , to allow hood to be raised and lowered electronically All models from XD511059	VUB105510

HOODS MG F (SEP 95 TO FEB 02) & MG TF (FEB 02 ON)

CLASSIC HOOD with soft backlight, black MG F to WD24604 MG F from WD24605 and MG TF	XPT000086PMA XPT000087PMA XPT000087RIO XPT000087HWP XPT000087JZP XPT000087LZD XPT000087CVG
beige All models	
green All models	
blue All models	
grey All models	
burgundy 75th Anniversary All models	
X-POWER SPORTSTER HOOD with heated glass backlight, All models	XPT000107JXP XPT000107JZP XPT000107SBT XPT000107HWP XPT000107LZD XPT000107CVG XPT000107CXP XPT000107PMA XPT000107LFM XPT000107RIO XPT000107CYP XPT000107FXP
bright blue with black lining	
dark blue with black lining	
driftwood fleck with black lining	
green with black lining	
grey with black lining	
burgundy with black lining	
red with black lining	
black	
dark grey with black lining	
beige with black lining	
purple with black lining	
yellow with black lining	
HOOD BACKLIGHTS REPLACEMENT soft backlight assembly, All models	XPT000091PMA XPT000091RIO XPT000091HWP XPT000091JZP XPT000091LFM XPT000091LZD XPT000091CCV XPT000091CVG
black	
beige	
green	
blue	
dark grey	
grey	
burgundy	
burgundy 75th Anniversary	





MG F (SEP 95 TO FEB 02) & MG TF (FEB 02 ON)

PRICES
SEE PAGES 124-151
OR VISIT OUR
WEBSITE



HOOD CARE PRODUCTS

MG F (SEP 95 TO FEB 02) & MG TF (FEB 02 ON)

RENOVO DRY CLEAN SHAMPOO for Canvas/Mohair
300ml **RX1530**

RENOVO SOFT TOP REVIVER for Canvas/Mohair
500ml Black **RX1525BLACK**
500ml Blue **RX1525BLUE**
500ml Brown **RX1525BROWN**
1 Litre Black **RX1524BLACK**
1 Litre Blue **RX1524BLUE**
1 Litre Brown **RX1524BROWN**

RENOVO ULTRA PROOFER for Canvas/Mohair
500 ml **RX1527**
1 Litre **RX1526**

RENOVO PLASTIC WINDOW POLISH
removes scratches and discolouration
30 ml **RX1531**
100 ml **RX1532**

AUTOGLYM FABRIC HOOD KIT inc Cleaner 500 ml,
Protector 500ml & Sponge **RX1433**

FABRIC HOOD SEAM SEALER 50ml **RX1257**

HARDTOPS

MG F (SEP 95 TO FEB 02) & MG TF (FEB 02 ON)

HERITAGE BLACK HARDTOP with Ambla headlining and
heated backlight, ready to fit
All model **HMP118099AMB**

MG ROVER PRIMED HARDTOP COMPLETE
Requires painting. All models **HMP118099MGR**

WALL HANGING BRACKET KIT for Hardtop storage
All models **VUB101340**

HARDTOP FITTING KIT All models **VUB000090**

HARDTOP STORAGE COVER tailored & machine
washable nylon All models **VUK100030PMA**

TONNEAU COVER

MG F (SEP 95 TO FEB 02) & MG TF (FEB 02 ON)

TONNEAU COVER 3 Part MG Logo Embossed Black Tonneau
and Hood Cover Kit All models **DSD100630PMA**

HOOD STOWAGE COVERS

MG F (SEP 95 TO FEB 02) & MG TF (FEB 02 ON)

HOOD STOWAGE COVERS All models
X-POWER Sportster version,
Red **XPT000123CPX**
Yellow **XPT000123FXP**
With cut-outs - Black **DSD000020PMA**
All models with MK1 (angled) OE roll hoops
Standard
Black **DSD000070PMA**
Light Smokestone **DSD000070LPR**
Light Tan **DSD000070SBA**
Red **DSD000070CVC**
Limited Edition
Brooklands Green **DSD100590RIO**
Walnut **DSD100590SAV**
Vinyl - Aftermarket **RP1043**

OE WINDSTOP - VUQ100280



WINDSTOPS

MG F (SEP 95 TO FEB 02) & MG TF (FEB 02 ON)

OE WINDSTOP Black frame with Black mesh & fitting kit
All models without Roll Hoops **VUQ100280**

AFTERMARKET WINDSTOP
All models without Roll Hoops **VUQ100280P**

MESH WINDSTOP tailored fit over hoops, Black
All models with MK2 OE Roll Hoops **XPT000135ACA**

PROTECTION & STOWAGE

MG F (SEP 95 TO FEB 02) & MG TF (FEB 02 ON)

**OUTDOOR "MONSOON" SEMI-TAILORED
CAR COVER** **RP1045**

VEHICLE DUST COVER **VUS100070PCREAM**

DRIVERS SEAT PROTECTOR
MG Badged **VUK100040PMA**

HOOD PROTECTION COVER **XPT000122ACA**

RUBBER MATS MG Logo **EAH103830LNF**

FABRIC MATS MG Logo
RHD **EAH103900PMA**
LHD **EAH103890PMA**

CARPET SET - Moulded (3 Pieces) various colours available
MG F RHD Models **RP1107**
MG F LHD Models **RP1108**
MG TF RHD Models **RP1110**
MG TF LHD Models **RP1111**

CARPET INSULATION KIT All Models **RP1109**

MUD GUARDS - Black
Front Pair MG Badged MGF **CAS100690PML**
Rear Pair MG Badged MG F **CAT100820PML**
Rear Pair MG Badged MG TF **CAT000320PML**

HEADLAMP PROTECTOR KIT (pair MG logo)
MG F **XBV100380**
MG TF **XBV000160**

FOG LAMP PROTECTOR KIT MG F **XBV100480**

TUNNEL CONSOLE LID ASSEMBLY All Models
Ash Grey Leather **FJB100450LNF**
Light Tan Leather **FJB100450SBA**

ANTI SLIP BOOT MAT 1m x 1.2m All models **VUB112420**

STYLING

MG F (SEP 95 TO FEB 02) & MG TF (FEB 02 ON)

LEATHER 'CLASSIC' SEATS
All models pair exchange **RP1149**

DOOR POCKETS All models pair **RP1150**

LEATHER COVERED DOOR PODS All models pair **RP1151**

LEATHER GEAR LEVER GAITER
MG F up to XD511058 **RP1152**

LEATHER HAND BRAKE GAITER All models **RP1153**

LEATHER COVERED CENTRE CONSOLE LID **RP1154**

LEATHER COVERED 'T' BAR All models exchange **RP1155**

'OCTAGON' DOOR LOCK RELEASE TRIM
All models pair **RP1156**

ALLOY HEATER CONTROL KNOB SET
MG F **RP1160**
MG TF **RP1161**

CARBON FIBRE FASCIA KIT
MG F up to XD511058 **VUB105120**

WOOD VENEER FASCIA KIT
light finish MG F up to XD511058 **VUB105140**
dark finish MG F up to XD511058 **VUB105130**

DASH TRIM KIT
Alloy Look MG F up to XD511058 **RP1092ALLOY**
Carbon Look MG F up to XD511058 **RP1092CARBON**
Walnut Look MG F up to XD511058 **RP1092WALNUT**

Alloy Look MG F from XD511059 **RP1093ALLOY**
Carbon Look MG F from XD511059 **RP1093CARBON**
Walnut Look MG F from XD511059 **RP1093WALNUT**

CONSOLE AND FASCIA VENT SET
Silver Finish All model from XD511059 **VUB105900**
Carbon Fibre All model from XD511060 **VUB105910**
Wood Effect All model from XD511061 **VUB105880**

BRIGHT CENTRE CONSOLE SURROUND
MG TF **FHD102460MWK**

BRIGHT DOOR GARNISH RAIL
RH MG TF **EJH000060MWK**
LH MG TF **EJH000070MWK**

CARPET SET - Moulded (3 Pieces) various colours available
MG F RHD Models **RP1107**
MG F LHD Models **RP1108**
MG TF RHD Models **RP1110**
MG TF LHD Models **RP1111**

CARPET INSULATION KIT All Models **RP1109**

CHROME ASH TRAY MG TF **FKH100230P**

BRIGHT ASH TRAY MG TF **FKH100160MWK**

STAINLESS MG LOGO TREAD PLATE
All models **EAP100790MMM**

HANDBRAKE GRIP All models

Black Leather
Ash Grey Leather (F Heritage)
Wood Look (80th Anniversary)
Bright (80th Anniversary)
Real Wood

SNE100080PMA
SNE100070LNF
SNE000120ANV
SNE000110MDC
VUB105580

CHROME HANDBRAKE BUTTON
All models from XD511059

SNJ100090MMM

GEAR KNOB All models

Black / Red Leather Sports A
Bright Alloy Finish
Alloy 2000 Style
MG Logo 'Touring'

UKJ100370RAK
UKJ100710MDC
UKJ100960MDC
RP1100

STEERING WHEEL All models

White Silver
Wooden Rim - MG badged

QTB001340MBG
VTH100060

COMPETITION PEDAL SET All models **RP1095**

MG TAX DISC HOLDER (available in silver or black) **RP1097**

PERFORMANCE EXHAUST TWIN ROUND EXITS
All models **XPT000039ACBP**

ELBOW JOINT required to fit exhaust
MG F up to YD522572 **XPT000039ACA**

GASKET required to fit exhaust
MG F up to YD522572 **WCM100480**

STEBEL AIR HORN All models
Red **XPT000005ACA**
Black **XPT002100AC**

LEXUS STYLE REAR LIGHT ASSEMBLIES
Black **XPT000152ACBP**

CLEAR INDICATOR AND REPEATER CONVERSION KIT
With Bulbs MG F **VUB105950**

CLEAR SIDE REPEATER LENS CONVERSION **RP1042**

REAR SPOILER 4 holes MG F **DFD101570LML**

FRONT SPOILER Trophy **DFB000010LML**

BRIGHT GRILLES KIT (front and side) MG F **VUB105300**

FRONT GRILLES - Stainless Steel
Woven Pattern MG F **RP1119WOVEN**

SIDE INTAKE GRILLES - Pair - Stainless Steel
Diamond Pattern MG F **RP1122DIAMOND**
Woven Pattern MG F **RP1122WOVEN**

GRILLE KIT - Front & Side intakes
Woven Pattern MG F **RP1125**

SIDE AIR DUCTS AND DIAMOND PATTERN GRILLE
Various Colours Available MG F **RP1120**

SIDE AIR DUCTS AND WOVEN PATTERN GRILLE
Green Only MG F **RP1121HFF**

ENAMEL UNION JACK BADGES, Pair, Self Adhesive,
50x30 mm **RX1299 STICK ON**

WAVED UNION JACK FLAG, Self Adhesive
(as fitted to late Rover vehicles) **DAG000080MMM**

GB LETTERS (self adhesive) **DAM100690MMM**



ALLOY GEAR KNOB -
UKJ100960MDC



MOULDED CARPET
SET IN BLUE
- RP1107



PRICES
SEE PAGES 124-151
OR VISIT OUR
WEBSITE

MG F (SEP 95 TO FEB 02) & MG TF (FEB 02 ON)



AUDIO/NAVIGATION

MG F (SEP 95 TO FEB 02) & MG TF (FEB 02 ON)

- 6 CD STORAGE BOX** For Glovebox or Boot Mounting
All models **VUB105600**
- 6 DISC AUTO CD CHANGER** All models **VUV100060**
- AUDIO INSTALLATION KIT** All models **VUD100380**
- SLIMLINE SUB WOOFER** All models **XPT000125ACA**
- ANTI THEFT AERIAL** (various colours available)
All models **RP1096**

MILLE MIGLIA STAINLESS STEEL
BOOT RACK - RP1123

SAFETY

MG F (SEP 95 TO FEB 02) & MG TF (FEB 02 ON)

- EXTERIOR TEMPERATURE WARNING KIT** **VUB100230**
- HEATED WASHER JET CONVERSION KIT**
All models **VUB100220**
- FIRE EXTINGUISHER**
600 gm Red **S3SSFE1**
Red, Powder, 1Kg **GAC9904X**
- PARKING AID UNIVERSAL KIT**
including 4 sensors and all fittings All models **RX1559**
- PARKING AID OE KIT** MG F **VUB104430**
- BASIC BULB KIT** All models **XPT000116ACA**
- HIGH MOUNTED STOP LAMP KIT** All models **XFN100180**
- ROADSIDE LAMP** All models **VUT100010**
- WARNING TRIANGLE** Universal All Models **RX1344**
- SAFETY VEST** (luminous) All Models **GAC2999**
- TOW ROPE** All Models **VUZ100010**
- FOGLAMPS**
MG F, RH **XBJ100260**
MG F, LH **XBJ100270**
MG TF, RH **XBJ100500**
MG TF, LH **XBJ100510**
- FOG LAMP SWITCH**
MG F to XD511058 **YUG101470PMA**
MG F & TF from XD511059 on **YUG102590PMP**
- FOG LAMP BRACKET**
MG TF, RH, from 4D622376 **DPL000180**
MG TF, LH, from 4D622376 **DPL000190**



16" 11 SPOKE
ALLOY WHEEL -
RRC002630MNH



16" SQUARE SPOKE
ALLOY WHEEL -
RRC113740MNH

MG F & MG TF

TOURING

MG F (SEP 95 TO FEB 02) & MG TF (FEB 02 ON)

- 7 BAR STAINLESS STEEL BOOT RACK** "Mille Miglia"
All models **RP1123**
- BLACK MG BADGED CASE** To Fit To Luggage Carriers
200 x 400 x 600mm All models **VTM100000**
- ELASTICATED STORAGE NET** For Boot Space **ESK100260**
- 7 BAR STAINLESS STEEL BOOT RACK** "Mille Miglia"
All models **RP1123**
- BOOT STOWAGE NET** All models **ESK100260**
- HEADLAMP CONVERTERS** MG Badged
MGF **XBV100580**
MG TF **XBV000160**
- PHONE MOUNTING KIT**
Magnetic All models **XPT000019ACB**
Mechanical All models **XPT000019ACA**
- TOURING XTRA KIT** All models **XPT000141ACA**
- ESSENTIALS XTRA KIT** All models **XPT000138ACA**
- INTERIOR CARE XTRA KIT** All models **XPT000139ACA**
(includes XPT000138ACA & XPT000139ACA) **RP1017**
- POWER SOURCE INVERTER** - converts 12V DC into 240V AC
150 watt model **RX1551-150**
300 watt model **RX1551-300**
500 watt model **RX1551-500**



MG TF WORKSHOP
MANUAL DVD - RP1077DVD

LITERATURE & MISC

MG F (SEP 95 TO FEB 02) & MG TF (FEB 02 ON)

- OWNERS HANDBOOKS**
MG F 1998 Vin 32146 to 504939 **VDH101280ENG**
MG F and early TF 1995 -
2002 up to 2D600289 **RCL0332ENG**
MG TF 2002 from 2D600290 u
p to 2D620548 **VDC000320EN**
MG TF 2003 onwards from 2D620549 **VDC000321EN**
- WORKSHOP MANUAL REPRINT**
512 pages MGF **RP1028**
516 pages MG TF **RP1077**
- MG TF WORKSHOP MANUAL DVD** **RP1077DVD**
- MG F AND MG TF PERFORMANCE PORTFOLIO**
1995 - 2005 All models **RP1029**
- HAYNES MODERN SPORTS CARS**
MGF All models **RP1030**
- MG F AND MG TF ULTIMATE BUYERS GUIDE**
All models **RP1032**
- MG X POWER SV** All models **RP1033**
- HAYNES "MAN" MANUAL** - 128 pages, Health Guide
in style of Workshop Manual **RX1534**
- HAYNES MANUAL PLASTIC PROTECTOR**
All Models **RX1569**
- MG F ADVERTISING POSTER** reprint
Red **RP1040**
Green **RP1039**
- MG F FRIDGE MAGNET** Red **RP1040FM**

WHEELS & FITTINGS

MG F (SEP 95 TO FEB 02) & MG TF (FEB 02 ON)

- WIRE WHEEL** Stainless Steel 7Jx16" Tubeless Bolt On
with Nuts and Centre Cap All models **RP1106**
- MINILITE WHEEL** 8 Spoke 6Jx15" Silver Sparkle
All models from XD511059 **RRC112882MNH**
- SQUARE 6 SPOKE WHEEL**
6Jx15" Silver Sparkle **RRC112832MNH**
All models from XD511059
7Jx15" Silver Sparkle **RRC113740MNH**
All models from XD511059
- ALULITE 6 SPOKE WHEEL**
7Jx16" Silver Sparkle MG TF **RRC110261MNH**
- MULTISPOKE WHEEL**
7Jx16" Charcoal MGTF **RRC110460LEH**
- 11 SPOKE WHEEL**
7Jx16" Silver Sparkle MG TF **RRC002630MNH**
7Jx16" Shadow Chrome MG TF **RRC002630MBM**
- TROPHY WHEEL** 7x16 Silver Sparkle **RRC001630MNH**
- WHEEL CENTRE CAP**
Silver Sparkle for wheels suffixed "MNH"
All models except Trophy **DTC100630MNH**
Optimum Silver for wheels RRC002630MBM
MG TF **DTC100630MNVY**
Anthracite for wheels RRC002040LEH
Trophy and MG TF **DTC000080LEH**
Silver Sparkle Trophy **DTC000050MBA**
- ALLOY LOCKING WHEEL NUT** Set of 4 **XPT000175ACC**
- ALLOY WHEEL NUT** non locking **NAM9077**
- MG BADGED VALVE CAPS** **RRF100060**
- MG BADGED ANTI THEFT VALVE CAPS** **RRF100060PAT**
- BUMP STOP KIT** For 16" Wheels **RNV100050**
- WHEEL CLEANING BRUSH** (Fir Tree Shape) **KACB101**
- MWS WHEEL CLEANING KIT** **RX1405**
- AUTOGLYM CLEAN WHEELS** Alloy Wheel Cleaner
500ml **RX1322**
- AUTOGLYM ALLOY WHEEL SEAL** 450ml **RX1443**
- RIMWAX** Professional Wheel Polish and Sealer **RX1262**
- AUTOGLYM INSTANT TYRE DRESSING** **RX1368**
- TYRE WELD PUNCTURE REPAIR**
400ml **GAC9903X-400ML**
- DIGITAL TYRE PRESSURE GAUGE** **XPT000006ACA**
- TYRE TREAD DEPTH GAUGE** **27298**



WOOD/LEATHER
STEERING WHEEL - VTH100060



SILVER SPARKLE
WHEEL CENTRE CAP
- DTC100630MNH



MG ZR / ROVER 25 / STREETWISE (JULY 1999 ON)

PRICES
SEE PAGES 124-151
OR VISIT OUR
WEBSITE



SERVICE PARTS

MG ZR / ROVER 25 / STREETWISE (JULY 1999 ON)

SERVICE KIT

inc Air & Oil filters, Sump Plug Washer and 4 Sparkplugs

Petrol, All models - exc: MG ZR 160 **RP1009**
Diesel, All models **RP1118**

AIR FILTERS

Petrol, All models - exc: MG ZR 160 **PHE000121**
Diesel, All models - inc: MG ZR 160 **PHE100331**

PIPERCROSS INDUCTION KIT

1.4/1.6/1.8 Models **XPT000178PXI**

PIPERCROSS VIPER INDUCTION KIT

1.4/1.6/1.8 Models **XPT000182PXV**

PIPERCROSS REPLACEMENT PANEL FILTER

Fits in standard air box

1.4/1.6/1.8 Models **XPT000184XP**
MG ZR 2.0 Turbo Diesel **XPT000185XP**

K&N "571" INDUCTION KIT

Incs. Intake Duct, Filter & Cold Air Hose

Petrol 1.4 & 1.8 **RP1062**
Rover 25/MG ZR 2.0 TD Models **RP1086**

K&N "GEN.2" INDUCTION KIT

Incs. Freeflow Intake Duct, Filter, Heat Shield & Cold Air Hose

MG ZR 1.4i **RP1063**
Rover 25 1.4i **RP1091**
MG ZR VVC 180BHP **RP1085**

FUEL FILTERS

Petrol, All models **WJN101191**
Diesel, All models **WJN000130**
LPG Gas Conversion **WJN000100**

OIL FILTERS

Petrol, All models **LPW100181**
Diesel, All models **ERR5542**

CRANKSHAFT FRONT OIL SEAL 2.0 Diesel

AHU2198

POLLEN FILTERS All models

JKR100020

GLOW PLUGS Diesel, All models

NCC100050L

SPARK PLUGS

Petrol, All models - exc: LPG conversion **NLP100290**
LPG conversion **NLP000090**

WIPER BLADES

Blade-windscreen wiper, driver, RHD vehicles **DKG101060**
driver, LHD vehicles **DKC101070**
passenger **DKC101090**
Blade-backlight wiper Pre-facelift **DKK100730**
Facelift models (from 5D778997) **DKC000099PMA**

FUEL DELIVERY In Tank Fuel Pump & Sender Unit

Petrol, All models **WFX101010**
Diesel, All models **WFX101380**

TIMING BELTS

1.1/1.4/1.6/1.8 Petrol, 26mm wide - exc: VVC **LHN100560**
1.4/1.6/1.8 Petrol, 23mm wide - exc: VVC **CDU2749**
1.8 VVC, front **LHN100390**
1.8 VVC, rear **LHN100400**
Diesel, All models **LHN100760**

TIMING BELT KIT (includes belt & tensioner)

1.4/1.6/1.8 Petrol, 23mm wide, non auto tensioning - exc: VVC **RP1071**
1.1/1.4/1.6/1.8 Petrol, 26mm wide, auto tensioning - exc: VVC **RP1078**
1.8VVC **RP1079**

ALTERNATOR BELTS

Petrol - exc: air-con **PQS100840**
Petrol, air-con only **PQS101590**
Diesel - exc: air-con **PQS101030**
Diesel, air-con only **PQS100851**

DISTRIBUTOR CAPS All models

NJD10010

ROTOR ARMS All models

NJE100070SLP

BRAKING

MG ZR / ROVER 25 / STREETWISE (JULY 1999 ON)

BRAKE DISC,

front each
Solid **SDB100500**
Vented -exc: 160PS MG ZR X-Power **SDB000990**
Vented, 160PS MG ZR X-Power **SDB000440**
rear each
Solid - exc: 160PS MG ZR **EGP1254**
Solid, 160PS MG ZR **SDB000290**

BRAKE PADS

front (1 Set)
Solid - exc: 160PS MG ZR
Vented - exc: 160PS MG ZR
160PS MG ZR
rear (1 Set)
Solid - exc: 160PS MG ZR
Solid, 160PS MG ZR

SEB000290SLP
SFP000390
SFP000370

EJP1437
SFP000080
SFS100090

BRAKE SHOES, rear (1 Set) All models

BRAKE WHEEL CYLINDERS, rear All models,

RH, up to YD610099
RH, from YD610100
LH, up to YD610099
LH, from YD610100

SML100080
SML000020
SML100090
SML000030

HANDBRAKE CABLES

Disc brakes - rear, RH
Disc brakes - rear, LH
Drum brakes - rear, RH
Drum brakes - rear, LH

SPB000370
SPB000360
SPB000340
SPB000350

ENGINE

MG ZR / ROVER 25 / STREETWISE (JULY 1999 ON)

CYLINDER LINER

K Series Engine Models

LCJ000050SLP

SEALANT For Use when Fitting Cylinder Liner

K series Engine Models

GGC102

CYLINDER HEAD BOLT 1.1/1.4/1.6/1.8 Petrol

WAM2293

EXHAUST VALVE

1.1 & 1.4 Petrol, 8 Valve Models

LGH101180

SEAL - camshaft oil -

Black, front 1.1-1.4-1.6-1.8 Petrol
Red, rear 1.1-1.4-1.6-1.8 Petrol
Front & Rear 2.0 Diesel

LUC100290SLP
LUC100220SLP
LZB100271

CAM COVER GASKET 1.8VVC

LVP100630

HEAD GASKET SET

1.1-1.4-1.6-1.8 Petrol (Exc. VVC)

1.8 VVC

2.0 Diesel

Head Gasket not included due to variable Thickness

LVQ000091SLP
LVQ000101SLP
LVQ101010

HEAD GASKET ONLY

2.0 Diesel (1.05mm Thickness - 1 HOLE)

2.0 Diesel (1.20mm Thickness - 2 HOLE)

2.0 Diesel (1.35mm Thickness - 3 HOLE)

LVB100910
LVB100920
LVB100930

SUMP GASKET 1.1 - 1.4 Petrol

LVF100290

CLUTCH

MG ZR / ROVER 25 / STREETWISE (JULY 1999 ON)

CLUTCH CABLES,

RHD vehicles

1.1/1.4/1.6 Petrol, up to 3D720772

1.1/1.4/1.6 Petrol, from 3D720773

1.8 Petrol

Diesel, All models

LHD vehicles

1.1/1.4/1.6 Petrol, up to 3D720772

1.1/1.4/1.6 Petrol, from 3D720773

1.8 Petrol

Diesel, All models

UUC101240
UUC000040
UUC101260
UUC101260

UUC101250
UUC000050
UUC101270
UUC101270

CLUTCH KITS

1.1/1.4/1.6 Petrol, manual, R65 Gearbox,

up to 3D720772 - exc: VVC

from 3D720773 - exc: VVC

1.6 - VVC/1.8 Petrol

1.1/1.4/1.6 Petrol, manual, IBS Gearbox

2.0 Diesel, Tcic

2.0 Diesel, TcicM

URF000170
URF000170
URF000121
URF000150

URF000131
URF000060

CLUTCH COVER

1.1/1.4/1.6 Petrol, manual - exc: VVC

1.6 - VVC/1.8 Petrol

2.0 Diesel, Tcic

2.0 Diesel, TcicM

URB10034
URB10009
URB10035
URB100440

CLUTCH PLATES

1.1/1.4/1.6 Petrol, manual,

up to 3D720772 - exc: VVC

from 3D720773 - exc: VVC

1.6 - VVC/1.8 Petrol

1.6 Petrol, auto.

2.0 Diesel, Tcic

2.0 Diesel, TcicM

URF000170
UQB000200
UQB000221
UQB000060
UQB100692
UQB10017

CLUTCH RELEASE BEARINGS

1.1/1.4/1.6 Petrol, manual,

up to 3D720772 - exc: VVC

from 3D720773 - exc: VVC

1.6 - VVC/1.8 Petrol

Diesel, All models

UTJ100100
UTJ000020
UTJ100170
UTJ100170

COOLING

MG ZR / ROVER 25 / STREETWISE (JULY 1999 ON)

RADIATORS

Petrol, All models, up to 2D471564
Petrol, All models, from 2D471565
Diesel, All models, up to 4D778997
Diesel, All models, from 5D778998

PCG104671
PCC001660SLP
PCC013541SLP
PCC113541SLP

THERMOSTATS Petrol, All models

PEL100116

WATER PUMPS

Petrol, All models
Diesel, All models

PEB102510SLP
PEB102420

RIDGED COOLANT PIPE - Thermostat to Bottom Hose

1.4/1.6/1.8 Petrol **PEP102160**

ELECTRICAL

MG ZR / ROVER 25 / STREETWISE (JULY 1999 ON)

BATTERIES

1.1/1.4/1.6 Petrol manual, up to YD613890

1.1/1.4/1.6 Petrol manual, from YD613891

1.4/1.6/1.8 Petrol auto., up to YD614986

1.4/1.6/1.8 Petrol auto., from YD614987

1.8 MG ZR Petrol

Diesel, All models

YGD101030

ZUA000063E

ZUA000027E

ZUA000027E

ZUA000096E

ENGINE SENSORS

Oxygen multi point injection Sensor

1.1/1.4/1.6/1.8 Petrol,

up To YD471564 & All 1.8 VVC

Pre Catalyst 1.1/1.4/1.6/1.8 Petrol

from YD471565

1.1/1.4/1.6 Petrol from YD471565

1.8 Petrol from YD471565

Air Flow Meter Sensor 2.0 Diesel,

Up To YD471584

From YD471585

Crank Sensor

1.1/1.4/1.6/1.8 Petrol, All models

MHK10006

MHK100840

MHK101086

MHK101201

MHK100360

MHK101070

NSC100760

EXHAUST SYSTEM

MG ZR / ROVER 25 / STREETWISE (JULY 1999 ON)

CATALYTIC CONVERTER - Downpipe

1.1/1.4/1.6 Petrol, manual,

up to 2D610560

from 2D610561 to 3D720772

1.1 Petrol, manual, from 3D720773*

1.4/1.6 Petrol, manual, from 3D720773

1.6 Petrol, auto.

1.8 MG ZR Petrol

up to 3D683540 - exc: VVC

manual, from 3D683541 up to

4D745247 - exc: VVC

manual, VVC, up to YD600075

1.8 MG ZR 160 PS Petrol, manual, VVC,

from 3D715897

Diesel, All models

WCD001890

WCD001901

WCD001860

WCD001851

WCD001880

WCD001881

WCD



PRICES
SEE PAGES 124-151
OR VISIT OUR
WEBSITE

MG ZR / ROVER 25 / STREETWISE (JULY 1999 ON)



LIGHTING

MG ZR / ROVER 25 / STREETWISE (JULY 1999 ON)

HEADLAMPS

RHD vehicles - headlamp levelling *All models*

RH, up to 3D690894 - exc: MG ZR **XBC104980**
LH, up to 3D690894 - exc: MG ZR **XBC104990**
RH, MG ZR up to 3D690894 **XBC000560**
LH, MG ZR up to 3D690894 **XBC000570**
RH, from 3D690895 up to 4D778996 **XBC000560**
LH, from 3D690895 up to 4D778996 **XBC000570**

RHD vehicles *All models* - exc: Streetwise/MG ZR

RH, from 5D778997 up to 5D798500 **XBC002880**
LH, from 5D778997 up to 5D798500 **XBC002890**
RH, from 5D798501 **XBC002970**
LH, from 5D798501 **XBC002980**

RHD vehicles MG ZR,

RH, from 5D778997 up to 5D798500 **XBC002990**
LH, from 5D778997 up to 5D798500 **XBC002910**
RH, from 5D798501 **XBC002990**
LH, from 5D798501 **XBC003000**

RHD vehicles Streetwise,

RH, from 5D778997 **XBC000560**
LH, from 5D778997 **XBC000570**

LHD vehicles - headlamp levelling *All models*,

RH, up to 3D689954 - exc: MG ZR **XBC104960**
LH, up to 3D689954 - exc: MG ZR **XBC104970**
RH, up to 3D689954 **XBC000580**
LH, MG ZR up to 3D689954 **XBC000590**
RH, from 3D689955 up to 4D778996 **XBC000580**
LH, from 3D689955 up to 4D778996 **XBC000590**

LHD vehicles *All models* - exc: Streetwise/MG ZR,

RH, from 5D778997 **XBC003010**
LH, from 5D778997 **XBC003020**

LHD vehicles MG ZR,

RH, from 5D778997 **XBC003030**
LH, from 5D778997 **XBC003040**

LHD vehicles Streetwise,

RH, from 5D778997 **XBC000580**
LH, from 5D778997 **XBC000590**

INDICATOR LAMPS *All models*,

RH, up to 4D732813 **XBD000060**
RH, from 4D732814 up to 4D778996 - exc: Streetwise **XBD000120**
LH, up to 4D732813 **XBD000070**
LH, from 4D732814 up to 4D778996 - exc: Streetwise **XBD000130**
RH, from 5D778997 - exc: Streetwise **XBD000160**
LH, from 5D778997 - exc: Streetwise **XBD000170**
Streetwise, from 4D733154 up to 5D778997 **XBD000090**
Streetwise, from 5D778997 **XBD000180**

CLEAR SIDE REPEATER LAMP CONVERSION KIT

Includes 2 Clear Side repeater lamps & 2 Amber Bulbs

All models **RP1042**

REAR LAMPS *All models*,

RH, - exc: MG ZR **XFB10088**
LH, - exc: MG ZR **XFB10089**
RH, MG ZR **XFB000340**
LH, MG ZR **XFB000350**

TECHNO DESIGN LED REAR LAMPS (Pair)

Chrome *All models* **XPT000094ACAPTECCHRM**
Black *All models* **XPT000094ACAPTECHBLK**

HEADLAMP BULBS

Main beam, h1-55 Watt, headlamp levelling **GLB448**
H7, headlamp levelling **XZQ000210**
Capless, clear - Bulb-501, w10/5-5 Watt **GLB501**

INDICATOR LAMP BULBS

Yellow, direction indicator **XZQ100190L**
Bulb-344, 21 Watt
Orange, side repeater **XZQ100210L**
Bulb-382, p25/1-21 Watt

REAR LAMP BULBS

Bulb-245, r19/10-10 Watt **GLB245**
Clear - Bulb-382, p25/1-21 Watt **GLB382**
Yellow, direction indicator **XZQ100190L**
Bulb-344, 21 Watt



STEERING & SUSPENSION

MG ZR / ROVER 25 / STREETWISE (JULY 1999 ON)

TRACK CONTROL ARM

All models,

RH - exc: MG ZR X-Power **RBJ100781**
LH - exc: MG ZR X-Power **RBJ100791**
MG ZR X-Power (Note: fit in pairs up to 4D770230)
RH, **RBJ100781**
LH **RBJ100791**

BUSH *All models*, RH & LH

EGP1673

ANTI ROLL BAR LINK *All models*, RH & LH

EGP1662

DRIVE SHAFT GAITER KIT

inner 1.1/1.4/1.6 Petrol, manual,

up to 3D720772 **EJP1509**

from 3D720773 **TDR000280SLP**

inner 1.6 auto./1.8 Petrol **TDR000200**

inner Diesel, *All models* **TDR000230**

outer Petrol, *All models* **TDR000140**

outer Diesel, *All models* **BAU5441**

OUTER CV JOINT *All Petrol Models With ABS*

TFB000090E

SHOCK ABSORBERS

front

1.1/1.4/1.6 Petrol, manual - exc: MG/sports suspension **RND105860**

1.4/1.6 Petrol, manual, sports suspension **RND106030**

1.6 Petrol, auto., sports suspension **RND106050**

1.8 Petrol, manual, sports suspension **RND106050**

2.0 Diesel - exc: MG ZR 2.0 Turbo Diesel **RND105870**

MG ZR, *All models* **RNB000340**

Streetwise, Petrol **RNB001090**

Streetwise, Diesel **RNB001180**

rear

1.1/1.4/1.6 Petrol **RPD102970**

1.8 Petrol - exc: sports suspension **RPD102970**

1.8 Petrol, sports suspension - exc: MG ZR **RPD102740**

2.0 Diesel - exc: MG ZR 2.0 Turbo Diesel **RPD102970**

MG ZR, *All models* **RPD000290**

COIL OVER SUSPENSION KIT - Gaz (Front & Rear)

MG ZR, *All models* **RP1101**

STEERING RACK GAITER KIT *All models*

QEY000050

TRACK ROD ENDS *All models*

QJB100240

WHEEL BEARING KIT

front *All models*

rear *All models* - exc: A.B.S. **RFM000060**

rear A.B.S., with disc rear brakes **RLB000050**

rear A.B.S., with drum rear brakes **RLB000060**

RLB000070

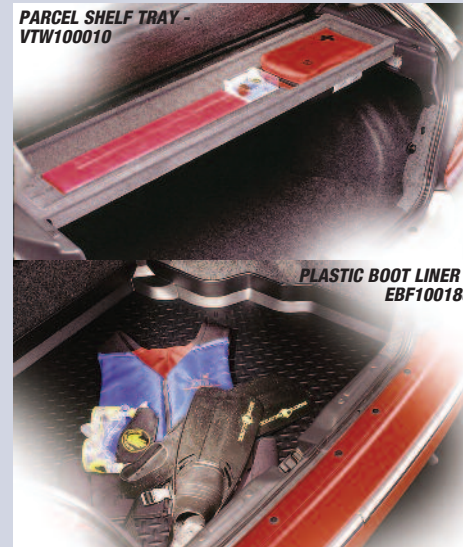

PARCEL SHELF TRAY - VTW100010

PLASTIC BOOT LINER - EBF100180

COLLISION PARTS - FRONT

MG ZR / ROVER 25 / STREETWISE (JULY 1999 ON)

BONNET *All models*

BKA450080

BUMPERS

All models, up to 3D694166 **DPC000360LML**

All models, from 3D694166 up to 4D779020 **DPC000360LML**

- exc: MG ZR/Streetwise **DPC000360LML**

All models, from 5D779021 **DPB002600LML**

- exc: MG ZR/Streetwise **DPB002600LML**

MG ZR, **DPC000680LML**

from 3D694166 up to 4D779020 **DPB002610LML**

from 5D779021 **DPC001120LZY**

Streetwise, *All models*

FRONT PANEL

Front panel assembly, 3 door & 5 door **ABB470010**

Headlamp mounting **ABH470080**

RH **ABH470090**

LH **ABG470010**

Bonnet slam panel **ABU470170**

Bracket - centre stay **ABC450050**

Cross member - lower* **ASB470040**

FRONT WING *All models*

RH **ASB470050**

LH **ASB470050**

GRILLE

Bright - exc: MG ZR **DHB102550MMM**

Chrome/Black Sport - exc: MG ZR **DHB107720RHT**

Bright MG ZR **DHB000060LZW**

Streetwise, upper, RH **DQY000300PMD**

Streetwise, upper, LH **DQY000310PMD**

Streetwise, lower **DQY000290PMD**

COLLISION PARTS - REAR

MG ZR / ROVER 25 / STREETWISE (JULY 1999 ON)

REAR BUMPER

All models,

up to 4D779020 - exc: MG ZR **DQC000190LML**

from 5D779021 - exc: MG ZR **DQC001540LML**

MG ZR **DQC000190LML**

up to 3D691652 **DQC000530LML-R1**

from 3D691653 up to 5D779020 **DQC001540LML**

from 5D779021 **AQA470010**

REAR PANEL ASSEMBLY *All models*

PROTECTION & STOWAGE

MG ZR / ROVER 25 / STREETWISE (JULY 1999 ON)

PLASTIC BOOT LINER *All models*

EBF100180

DOOR WIND DEFLECTORS

3 Door models **VUB104660**

5 Door models **VUB104670**

SUNROOF WIND DEFLECTOR *All models*

EFJ100180

HEADLAMP PROTECTOR KIT

All models up to 4D779020 **XBV100780**

All models from 5D779021 **XPT000113ACA**

MUD GUARDS

Front Pair **CAS100270PMA**

All models **CAS000290LNF**

exc. where side sills are fitted & Streetwise

Streetwise **CAT101190PMA**

Rear Pair **CAT000380LNF**

All models to August 2004 **CAT101190PMA**

exc. Streetwise. **CAT000380LNF**

Streetwise

MG LOGO FABRIC MAT SET

black MG models RHD **EAH000760PPA**

ROVER LOGO FABRIC MAT SET

Sandstone Beige **EAH105300SCD**

All models RHD, From YD471565

'STREET GEAR' RUBBER MATS Front Pair

Streetwise RHD **XPT000034ACA**

Streetwise LH **XPT000038ACA**

PARCEL SHELF TRAY *All models*

VTW100010

STOWAGE KIT fits over back of seat,

Ash Grey *All models* **VUB106010LNF**

Sandstone Beige *All models* **VUB106010SCD**

NOTES



MG ZR / ROVER 25 / STREETWISE (JULY 1999 ON)

PRICES
SEE PAGES 124-151
OR VISIT OUR
WEBSITE



CHROME DOOR MIRROR COVERS - CRC100960MMM



STYLING

MG ZR / ROVER 25 / STREETWISE (JULY 1999 ON)

CHROME DOOR MIRROR COVERS (pair)
All models **CRC100960MMM**

M3 STYLE MIRRORS Black, Pair,
Electric All models **XPT000035ACA**
Manual All models **XPT000035ACB**

M3 STYLE MIRROR MOUNTING BRACKETS
All models **XPT000036ACA**

SIDE SILL FINISHERS Full Length, pair, primed
will not fit with front Mud Guards
All models (exc. MG) **VUB105980LML**

SPORTS SILL FINISHERS Short, pair, primed
Will not fit with front Mud Guards
RH All models (exc. MG) **VUB002990LML**
LH All models (exc. MG) **VUB003020LML**

SIDE SKIRT Can be Retro fitted to Rover 25 models.
RH MG models up to August 2004 **DDJ101081LML**
LH MG models up to August 2004 **DDJ101091LML**
RH MG models August 2004 on **DDJ000720LML**
LH MG models August 2004 on **DDJ000730LML**

CLIPS (10 required) Can be Retro fitted to Rover 25 models.
MG models up to August 2004 **DDQ000050**
MG models August 2004 on **EKM100270**

END CAP Can be Retro fitted to Rover 25 models.
RH MG models up to August 2004 **DDJ000380**
LH MG models up to August 2004 **DDJ000390**
RH MG models August 2004 on **DQM000160**
LH MG models August 2004 on **DQM000170**

TAPE For use when fitting side skirts - All models **DYN000040L**

WHEEL ARCH FLAIR KIT, paintable
3 door models **VUB002660PMA**

REAR SPOILER ASSEMBLY - Tailgate - primed
MG ZR from 5D791225 **ZUA000510ML**

TAILGATE SPOILER (Sienna Gold)
YD471565 To 3D719340 **DFD101650GUF**

SPORTS DESIGN REAR LAMPS
All models **XPT000132ACA**

STEBEL AIR HORN All models
Red **XPT000005ACA**
Black **XPT002100AC**

8 PIECE DASH TRIM KIT All models August 2004 on
Alloy Effect **RP1105ALLOY**
Carbon Effect **RP1105CARBON**
Walnut Effect **RP1105WALNUT**

GEAR SHIFT SURROUND All models **RP1094**

MG LOGO 'TOURING' GEAR KNOB MG models **RP1100**

COMPETITION PEDAL SET All models **RP1095**

MG TAX DISC HOLDER (available in silver or black)
MG models **RP1097**

ANTI THEFT AERIAL (various colours available)
All models **RP1096**

TOURING

MG ZR / ROVER 25 / STREETWISE (JULY 1999 ON)

TOWING MIRROR All models **CRB108270**

FIXED TOWBAR All models **KNB100470**

DETACHABLE TOWBAR All models **KNB105710**

CYCLE CARRIER for use with towbar with
13 pin electrics All models **VUB111910**
12N/12S electrics All models **VUB111900**

ROOF CROSS BARS
3 Door models - exc: Streetwise **CAB000060PMA**
5 Door models **CAB000070PMA**



SKI CLIPS - CAN10005

SKI CLIPS (pair) for use with Roof Bars
All models - exc: Streetwise **CAN10005**
Streetwise **CAN100140**

CYCLE CARRIER for use with Roof Bars
All models **XPT000096ACA**

CYCLE LIFT SYSTEM for use with Roof Bars
All models **CAN100170**

CONVERSION KIT FOR CYCLE LIFT SYSTEM
All models **CAP105290**

LOAD CARRYING ROOF RACK All models **CAN100130**

HEATED SEAT CONVERSION KIT All models **VUB106050**

LINK LEAD FOR HEATED SEAT KIT
All models from 3D704142 **VUB003280**

CONTINENTAL HEADLAMP CONVERTERS
All models up to 4D779020 **XBQ100940**
All models from 5D779021 **XPT000113ACB**

ACCESSORY POWER SOCKET **YXW000130PMA**

PHONE MOUNTING KIT
Magnetic **XPT000019ACB**
Mechanical **XPT000019ACA**

6 CD AUTO CHANGER
Rover Models YD599025 to 2D641740 **XQE000110PMP**

ESSENTIALS XTRA KIT **XPT000138ACA**

INTERIOR CARE XTRA KIT **XPT000139ACA**

ESSENTIALS & INTERIOR CARE KIT **RP1017**
Includes XPT000138ACA & XPT000139ACA

POWER SOURCE INVERTER
Converts 12V DC into 240V AC
150 watt model **RX1551-150**
300 watt model **RX1551-300**
500 watt model **RX1551-500**

TRAILER / REAR LIGHTING BOARD
4ft inc cable **RX1513**

TOWING ELECTRICS (13 pin European) **VUB104560**

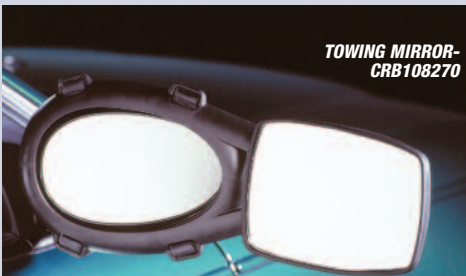

TOWING MIRROR - CRB108270

SAFETY

MG ZR / ROVER 25 / STREETWISE (JULY 1999 ON)

EXTERIOR TEMPERATURE WARNING KIT **VUB100230**

HEATED WASHER JET CONVERSION KIT **VUB100220**

FIRE EXTINGUISHER
600gm Red Alloy **S3SSFE1**
Red, Powder, 1Kg **GAC9904X**

PARKING AID OE KIT
All models up to 4D778996 **VUB104430**

PARKING AID UNIVERSAL KIT
including 4 sensors and all fittings All models **RX1559**

ROADSIDE LAMP **VUT100010**

WARNING TRIANGLE Universal All models **RX1344**

SAFETY VEST (luminous) **GAC2999**

FOG LAMP FITTING KIT - paintable
All models up to YD563813 **XBQ100960**
All models from YD563814 up to 4D778996 **XBQ000130**

FOG LAMP
LH All models **XBQ100960**
RH All models **XBQ000130**

FOG LAMP SWITCH
All models up to 4D778996 **YUG101680PMP**

FOG LAMP RELAY All models from 5D778997 **YWB000440**

LITERATURE

MG ZR / ROVER 25 / STREETWISE (JULY 1999 ON)

OWNERS HANDBOOKS

Rover models vin 599005 to vin 672953 **VDC000140EN**

Rover models vin 683541 to vin 704355 **VDC000400EN**

Rover models vin 704356 to vin 732813 **VDC000460EN**

Rover models vin 732814 to vin 778996 **VDC000461EN**

Rover models vin 778997 on **VDC000580EN**

Streetwise vin 732814 to vin 778996 **VDC000520EN**

Streetwise vin 778997 on **VDC000620EN**

MG models vin 599005 to vin 672953 **VDC000150EN**

MG models vin 672954 to vin 683540 **VDC000370EN**

MG models vin 683541 to vin 704355 **VDC000430EN**

MG models vin 704356 to vin 732813 **VDC000470EN**

MG models vin 732814 to vin 778996 **VDC000471EN**

MG models vin 778997 on **VDC000590EN**

WORKSHOP MANUAL All models **RP1004**

HAYNES "MAN" MANUAL - 128 pages,
Health Guide in style of Workshop Manual **RX1534**

HAYNES MANUAL PLASTIC PROTECTOR **RX1569**

WHEELS & FITTINGS

MG ZR / ROVER 25 / STREETWISE (JULY 1999 ON)

HAIRPIN WHEEL 6.5J x 16
MG ZR X Power **RRC114710MNH**

STRAIGHTS WHEEL 7J x 17
MG ZR - exc X Power **RRC001500MNH**

MIRAGE WHEEL 6J x 15
All models from 4D623380 **RRC005330MNH**

ALLOY WHEEL NUT non locking **RRD100500**

ALLOY LOCKING WHEEL NUT Set of 4 **RRB100140**

MG BADGED VALVE CAPS MG models **RRF100060**

MG BADGED ANTI THEFT VALVE CAPS
MG models **RRF100060PAT**

SNOW CHAINS pair For 175/65 x 14 and 185/60 x 14 tyres
14" wheel models **VUJ10002**

WHEEL CLEANING BRUSH (Fir Tree Shape) **KACB101**

MWS WHEEL CLEANING KIT **RX1405**

RIMWAX Professional Wheel Polish and Sealer **RX1262**

AUTOGLYM CLEAN WHEELS Alloy Wheel Cleaner
500ml **RX1322**

AUTOGLYM ALLOY WHEEL SEAL 450ml **RX1443**

AUTOGLYM INSTANT TYRE DRESSING **RX1368**

TYRE WELD Puncture Repair (Holts Brand)

300ml **GAC9903X-300ML**

400ml **GAC9903X-400ML**

DIGITAL TYRE PRESSURE GAUGE **XPT000006ACA**

TYRE TREAD DEPTH GAUGE **27298**

NOTES



16" HAIRPIN ALLOY WHEEL - RRC114710MNH



PRICES
SEE PAGES 124-151
OR VISIT OUR
WEBSITE

MG ZS / ROVER 45 (JUNE 1999 ON)



MG ZS / ROVER 45

SERVICE PARTS

MG ZS / ROVER 45 (JUNE 1999 ON)

SERVICE KIT

- inc Air & Oil filters, Sump Plug Washer and 4 Sparkplugs
1.4/1.6/1.8 Petrol Models **RP1010**
inc Air & Oil filters, Sump Plug Washer and 6 Sparkplugs
2.0/2.5 V6 Models **RP1059**
inc Air, Oil & Fuel filters and Sump Plug Washer
2.0 Diesel **RP1118**

AIR FILTERS

- 1.4/1.6/1.8 Petrol, 2.0 Diesel **PHE100331**
2.0 Petrol **PHE105590**
MG ZS 2.5 Petrol **PHE105590**

PIPERCROSS INDUCTION KIT

- 1.4/1.6/1.8 Petrol Models **XPT000178PXI**
2.5 Petrol V6 Models (MG ZS 180) **XPT000179PXI**

PIPERCROSS VIPER INDUCTION KIT

- 1.4/1.6/1.8 Petrol Models **XPT000182PXV**
2.5 Petrol V6 Models (MG ZS 180) **XPT000183PXV**

PIPERCROSS REPLACEMENT PANEL FILTER

- Fits in standard air box.
1.4/1.6/1.8 Petrol Models **XPT000184PXP**

K&N "571" INDUCTION KIT

- Incs. Intake Duct, Filter & Cold Air Hose.
MG ZS 1.8 120 BHP Models **RP1087**

K&N "GEN.2" INDUCTION KIT

- Incs. Freeflow Intake Duct, Filter, Heat Shield & Cold Air Hose.
MG ZS 2.5 V6 Models **RP1088**

FUEL FILTERS

- Petrol, all models **WJN101191**
2.0 Diesel **WJN000130**

OIL FILTERS

- 1.4/1.6/1.8 Petrol **LPW100181**
2.0 Petrol **LPW100161**
2.0 Diesel **ERR5542**
MG ZS 2.5 Petrol **LPW100161**

CRANKSHAFT FRONT OIL SEAL 2.0 Diesel

AHU2198

POLLEN FILTERS

- All models, up to WD354434 - exc: air-con **JKX100010**
All models, from XD354435 - exc: air-con **JKR100220**
All models, air-con only **JKR100020**

GLOW PLUGS Diesel, all models

NCC100050L

SPARK PLUGS

- All models - exc: LPG conversion **NLP100290**
LPG conversion **NLP000090**

WIPER BLADES

- Blade-windscreen wiper, driver **DKC100690**
Blade-windscreen wiper, passenger **DKC100700**
Blade-backlight wiper, 5 door **DKC100730**

FUEL DELIVERY

- In Tank Fuel Pump & Sender Unit -
Petrol, All models **WFX100631**
Electric Pump Only Petrol, all models **RP1103**
Fuel Injection Pump - Diesel, TcIe **MSR100310E**
Fuel Injection Pump - Diesel, TcIeM **ERR6380E**

TIMING BELTS

- 1.4 Petrol,
23mm wide, up to eng. 646036/655216 **CDU2749**
26mm wide, from eng. 646037/655217 **LHN100560**
1.6 Petrol,
23mm wide, up to eng. 654922/655076 **CDU2749**
26mm wide, from eng. 654923/655077 **LHN100560**
1.8 Petrol, 26mm wide **LHN100560**
2.0 Petrol, front **LHN100410**
2.0 Petrol, rear **LHN100420**
2.0 Diesel
Front (112 teeth) **LHN100760**
Rear (Injection pump) **MVF100040**
MG ZS 2.5 Petrol, front **LHN100410**
MG ZS 2.5 Petrol, rear **LHN100420**

TIMING BELT KIT

- 1.4/1.6 Petrol, (includes belt & tensioner)
23mm wide, non auto tensioning **RP1071**
1.4/1.6/1.8 Petrol, 26mm wide, auto tensioning **RP1078**
2.0/2.5 V6 **RP1081**

ALTERNATOR BELTS

- 1.4/1.6/1.8 Petrol - exc: air-con **PQS100840**
1.4/1.6/1.8 Petrol, air-con only **PQS101590**
2.0 Petrol - exc: air-con **PQS101261**
2.0 Petrol, air-con only **PQS101272**
2.0 Diesel - exc: air-con **PQS101030**
2.0 Diesel, air-con only **PQS100851**
MG ZS 2.5 Petrol - exc: air-con **PQS101261**
MG ZS 2.5 Petrol, air-con only **PQS101272**

BRAKING

MG ZS / ROVER 45 (JUNE 1999 ON)

BRAKE DISC

- front each
Solid **SDB100500**
Vented - exc: MG ZS **SDB000990**
MG ZS 110PS **SDB000990**
MG ZS, vented - exc: 110 PS (282mm) **SDB000440**
rear each
All models - exc: MG ZS **EGP1254**
MG ZS **SDB000290**

BRAKE PADS

- front (1 Set)
Solid - exc: MG ZS **SFP000410**
Vented - exc: MG ZS **SFP000390**
MG ZS 2.5 Petrol **SFP000370**
rear (1 Set)
All models - exc: MG ZS **EJP1437**
MG ZS **SFP000080**

BRAKE WHEEL CYLINDERS, rear All models,

- RH, up to YD558484 **SML100080**
LH, up to YD558484 **SML100090**
RH, from YD558485 **SML000020**
LH, from YD558485 **SML000030**
RH, from YD558485 **SFS100090**

BRAKE SHOES, rear All models

HANDBRAKE CABLES

- Disc brakes-rear,
RH, from WD322149 up to 4D632463 **SPB000580**
RH, from 4D632464 **SPB000580**
LH, from WD250029 up to 4D632463 **SPB000590**
LH, from 4D632464 **SPB000590**
Drum brakes-rear,
RH, up to 4D633173 **SPB100700**
RH, from 4D633174 **SPB000560**
LH, up to 4D633173 **SPB000570**
LH, from 4D633174 **SPB000570**

ENGINE

MG ZS / ROVER 45 (JUNE 1999 ON)

CYLINDER LINER

- K Series & KV6 Engine Models **LCJ000050SLP**

SEALANT For Use when Fitting Cylinder Liner

- K series Engine Models **GGC102**

CYLINDER HEAD BOLT

- 2.0 - 2.5 V6 Petrol **LDN10027**
1.4/1.6/1.8 Petrol **WAM2293**

HYDRAULIC VALVE TAPPET

- 2.0 - 2.5 V6 Petrol **LGR000050**

EXHAUST VALVE 1.4 Petrol, 8 Valve Models

- LGH101180SLP**

SEAL - camshaft oil

- 1.4-1.6 & 1.8 K Series & 2.0-2.5 KV6
Black, front **LUC100290SLP**
Red, rear **LUC100220SLP**
Front & Rear 2.0 Diesel **LZB100271**

CYLINDER HEAD GASKET 2.0 & 2.5 V6 Petrol

- LVB101630**

HEAD GASKET SET

- 1.4-1.6-1.8 Petrol **LVQ000091SLP**
2.0 Diesel **LVO101010**
Head Gasket not included due to variable Thickness.

HEAD GASKET ONLY

- 2.0 Diesel (1.05MM.Thickness - 1 HOLE) **LVB100910**
2.0 Diesel (1.20MM.Thickness - 2 HOLE) **LVB100920**
2.0 Diesel (1.35MM.Thickness - 3 HOLE) **LVB100930**

PUMP ASSEMBLY 2.0 & 2.5 V6 Petrol

- LPF101290SLP**

SUMP GASKET 1.4-1.6 Petrol

- LVF100290**



CLUTCH

MG ZS / ROVER 45 (JUNE 1999 ON)

CLUTCH KITS

- 1.4/1.6 Petrol, R65 Gearbox, up to 3D618245 **URF000170**
1.4/1.6 Petrol, I85 Gearbox, from 3D618246 **URF000150**
1.8/2.0 Petrol, manual **URF000121**
2.0 Diesel, TcIe **URF000131**
2.0 Diesel, TcIeM **URF000060**
MG ZS 2.5 Petrol,
up to 3D608299 **URF000180**
from 3D608300 up to 3D615940 **URF000140**
from 3D615941 **URF000141**

CLUTCH COVER

- 1.4/1.6 Petrol **URB10034**
1.8/2.0 Petrol, manual **URB10009**
2.0 Diesel, TcIe **URB10035**
2.0 Diesel, TcIeM **URB100440**
MG ZS 2.5 Petrol **URB000190**

CLUTCH PLATES

- 1.4/1.6 Petrol,
up to eng. 133467/103723 **UQB100720**
from eng. 133468/103724 up to 3D618245 **URF000170**
1.4/1.6 Petrol, from 3D618246 **UQB000200**
1.8/2.0 Petrol, manual **UQB000221**
1.8 Petrol, auto. **UQB000060**
2.0 Petrol, auto. **TPB100210**
2.0 Diesel, TcIe **UQB100692**
2.0 Diesel, TcIeM **UQB10017**
MG ZS 2.5 Petrol **UQB100772**

CLUTCH RELEASE BEARINGS

- 1.4/1.6 Petrol, up to 3D618245 **UTJ100100**
1.4/1.6 Petrol, from 3D618246 **UTJ000020**
1.8/2.0 Petrol **UTJ100170**
MG ZS 2.5 Petrol **UTJ100170**
Diesel, all models **UTJ100170**

COOLING

MG ZS / ROVER 45 (JUNE 1999 ON)

RADIATORS

- 1.4/1.6/1.8 Petrol, manual,
large radiator - exc: air-con **PCC001610SLP**
large radiator **PCC001610SLP**
1.8 Petrol, auto. **PCC108352**
2.0 Petrol **PCC107800**
2.0 Diesel, TcIe **PCC105500SLP**
2.0 Diesel, TcIeM **PCC105520**
MG ZS 2.5 Petrol **PCC000820**

THERMOSTATS

- 1.4/1.6/1.8 Petrol **PEL10016**
2.0 Petrol (with housing) **PEM101050**
2.0 Diesel **PBM100040**
MG ZS 2.5 Petrol (with housing) **PEM101050**

WATER PUMPS

- 1.4/1.6/1.8 Petrol,
with evaporation chamber **PEB102510SLP**
2.0 Petrol **PEB102240**
2.0 Diesel **PEB102420**
MG ZS 2.5 Petrol **PEB102240**

RIGID COOLANT PIPE - Thermostat to Bottom Hose

- 1.1/1.4/1.6/1.8 Petrol **PEP102160**

ELECTRICAL

MG ZS / ROVER 45 (JUNE 1999 ON)

BATTERIES

- 1.4/1.6/1.8 Petrol, up to YD560543 **ZUA000063E**
1.4/1.6/1.8 Petrol, from YD560544 **ZUA000063E**
2.0 Petrol, up to YD561146 **ZUA000027E**
2.0 Petrol, from YD561147 **ZUA000027E**
2.0 Diesel **ZUA000096E**
MG ZS 2.5 Petrol, up to YD561146 **ZUA000027E**
MG ZS 2.5 Petrol, from YD561147 **ZUA000027E**

SENSOR - oxygen multi point injection

- 1.4 & 1.6 Petrol up to YD471063 **MHK10006**
Pre Catalyst 1.4/1.6/1.8 From YD471064 **MHK100840**
Post Catalyst 1.4/1.6/1.8 From YD471064 **MHK101086**

AIR FLOW METER

- 2.0 Diesel, Up To YD471063 **MHK100360**
2.0 Diesel From YD471064 **MHK101070**

HT LEAD SET 2.0 & 2.5 V6 Petrol

- NGC000020**

CRANK SENSOR 1.4/1.6/1.8 Petrol, All Models

- NSC100760**



MG ZS / ROVER 45 (JUNE 1999 ON)

PRICES
SEE PAGES 124-151
OR VISIT OUR
WEBSITE



EXHAUST SYSTEMS

MG ZS / ROVER 45 (JUNE 1999 ON)

CATALYTIC CONVERTERS

1.4/1.6 Petrol, up to 2D558670*	WCD001930
1.4/1.6 Petrol, from 2D558671 to 3D618245*	WCD001921
1.4/1.6/1.8 Petrol, from 3D618246*	WCD001840
1.8 Petrol, up to 3D618245*	WCD001940
2.0 Petrol	WAG104530
MG ZS 2.5 Petrol	WAG104530
2.0 Diesel	WAG104790

Replace rubber exhaust mounting along with downpipe.

DOWNPIPES 2.0 Diesel

For all other models Downpipes and Catalytic Converters are complete.

INTERMEDIATES

1.4/1.6 manual Petrol	WCE105260
1.8 manual Petrol	WCE105270SLP
1.8/2.0 Petrol, auto.	WCE104880
2.0 Diesel, up to YD545434	WCE110540
2.0 Diesel, from YD545435	WCE000460
MG ZS 2.5 Petrol, manual	WCE105270SLP

REAR ASSEMBLIES

1.4/1.6 Petrol, 4 door	WCG103441
1.4/1.6 Petrol, 5 door	WCG103431SLP
1.8 Petrol man./auto., 4 door -exc: 1.8 MG ZS 5 door -exc: 1.8 MG ZS	WCG103461 WCG103451
2.0 Petrol, 4 door	WCG103490
2.0 Petrol, 5 door	WCG103500
2.0 Diesel, 4 door	WCG103471
2.0 Diesel, 5 door	WCG103481SLP
MG ZS 110PS 1.6 Petrol, 4 door	WCG103441
MG ZS 110PS 1.6 Petrol, 5 door	WCG103431SLP
MG ZS 1.6 Petrol, 4 door - exc: 110PS	WCG000141
MG ZS 1.8 Petrol, 4 door, up to 5D637208	WCG000161
MG ZS 1.8 Petrol, 5 door, up to 5D637208	WCG000161P
MG ZS 2.5 Petrol, 4 door, up to 5D637208	WCG000190
MG ZS 2.5 Petrol, 4 door, from 5D637209	WCG000560PIPER
MG ZS 2.5 Petrol, 5 door, up to 5D637208	WCG000200
MG ZS 2.5 Petrol, 5 door, from 5D637209	WCG000570
MG ZS 2.0 Diesel, 4 door, from 5D637209	WCG000600
MG ZS 2.0 Diesel, 5 door, up to 5D637208	WCG000181
MG ZS 2.0 Diesel, 5 door, from 5D637209	WCG000610



LIGHTING

MG ZS / ROVER 45 (JUNE 1999 ON)

HEADLAMPS

RHD vehicles All models,	
RH, up to 5D637208 - exc: MG ZS/Japan	XBC104500
RH, from 5D637209 - exc: MG ZS	XBC002680
RH, up to 5D637208, Japan only	XBC104540
LH, up to 5D637208 - exc: MG ZS/Japan	XBC104510
LH, from 5D637209 - exc: MG ZS	XBC002690
LH, up to 5D637208, Japan only	XBC104550
Japan, RH	XBC104540
Japan, LH	XBC104550
RHD vehicles MG ZS,	
RH, up to 5D637208 - exc: Japan	XBC000640
RH, from 5D637209 - exc: Japan	XBC002720
LH, up to 5D637208 - exc: Japan	XBC000650
LH, from 5D637209 - exc: Japan	XBC002730
LHD vehicles All models,	
RH, up to 5D637208 - exc: MG ZS	XBC104520
RH, from 5D637209 - exc: MG ZS	XBC002700
LH, up to 5D637208 - exc: MG ZS	XBC104530
LH, from 5D637209 - exc: MG ZS	XBC002710
LHD vehicles MG ZS,	
RH, up to 5D637208	XBC000660
RH, from 5D637209	XBC002740
LH, up to 5D637208	XBC000670
LH, from 5D637209	XBC002750

REAR LAMPS

4 door, RH - exc. MG ZS
4 door, LH - exc. MG ZS
5 door, RH - exc. MG ZS
5 door, LH - exc. MG ZS
MG ZS, 4 door, RH
MG ZS, 4 door, LH
MG ZS, 5 door, RH
MG ZS, 5 door, LH

HEADLAMP BULBS

H7, all models
Clear, capless side lamp -
Bulb-501, w10/5-5 Watt
Yellow, direction indicator -
Bulb-344, 21 Watt

INDICATOR LAMP BULBS

Orange, side repeater -
Bulb-382, p25/1-21 Watt

REAR LAMP BULBS

Clear - Bulb-382, p25/1-21 Watt
Yellow, direction indicator -
Bulb-344, 21 Watt
4 door, Bulb-245, r19/10-10 Watt
5 door, Bulb-207, r19/55 Watt

STEERING & SUSPENSION

MG ZS / ROVER 45 (JUNE 1999 ON)

BALL JOINTS

1.4/1.6 Petrol
1.8/2.0/2.5 Petrol

DRIVE SHAFT GAITER KIT

Inner
1.4/1.6 Petrol, up to 3D618245
1.4/1.6 Petrol, from 3D618246
1.8 Petrol
2.0 Diesel
2.0 Petrol
MG ZS 2.5 Petrol
Outer
1.4/1.6/1.8 Petrol
2.0 Diesel
2.0 Petrol
MG ZS 2.5 Petrol

OUTER CV JOINT

1.4/1.6 Manual/1.8 Exc. ABS
1.4/1.6 Manual/1.8 ABS

SHOCK ABSORBERS

Front
All models, RH - exc: MG ZS
All models, LH - exc: MG ZS
MG ZS 1.6/1.8 Petrol, RH
MG ZS 1.6/1.8 Petrol, LH
MG ZS 2.0 Turbo Diesel, RH
MG ZS 2.0 Turbo Diesel, LH
MG ZS 2.5 Petrol, RH
MG ZS 2.5 Petrol, LH
Rear
All models - exc: MG ZS
MG ZS, all models

COIL OVER SUSPENSION KIT -

Gaz (Front & Rear) MG ZS, all models
Spax 'RSX' (Front & Rear) MG ZS (exc. V6)

STEERING RACK GAITER KIT All models

TRACK ROD ENDS All models,

RH
LH
Trailing Arm Assembly, rear
Drum Brakes,
RH, up to 3D603410
RH, from 3D603411
LH, up to 3D603410
LH, from 3D603411
Disc,
RH, up to 3D603410
RH, from 3D603411
LH, up to 3D603410
LH, from 3D603411

All Models, RH & LH

BUSH - Trailing Arm Assembly, rear

Disc, LH, from 3D603411

WHEEL BEARING KIT,

front All models
rear All models - exc: A.B.S.
rear A.B.S., with disc rear brakes
rear A.B.S., with drum rear brakes

XFB101000
XFB101010
XFB101420
XFB101430
XFB000360
XFB000370
XFB000380
XFB000390

XZQ000210

AFU4481

XZQ100190L

XZQ100210L

GLB382

XZQ100190L

GLB245

GLB207

RBK100350

RBK100380

TDR000180

TDR000280SLP

TDR000200

TDR100770

TDR100930

TDR100930

TDR000190

TDR100760

BAU5441

BAU5441

TFB000100E

TFB000110E

RNB104600

RNB104610

RNB000320

RNB000360

RNB000330

RNB000370

RNB000330

RNB000370

RPD102670

RPD000280

RP1102

RP1130

QEY000040

QGX100060

QGX100050

RGG104040

RGG104042

RGG104050

RGG104051

RGG104060

RGG104062

RGG104070

RGX100980

RUD100070

RLB000050

RLB000060

RLB000070

COLLISION PARTS - FRONT

MG ZS / ROVER 45 (JUNE 1999 ON)

BONNET All models

BKA140100

BUMPER

All models, up to 5D637208	DPC000250LML
All models, from 5D637209 -	
exc: headlamp powerwash/ZS	DPC001200LML
All models, headlamp powerwash,	
from 5D637209 - exc: MG ZS	DPC001200LML
MG ZS, from 5D637209	DPC001220LML

FRONT PANEL

Front panel assembly	ABB160010
Headlamp mounting, RH	ABH140180
Headlamp mounting, LH	ABH140190
Bonnet slam panel	ABG160020
Bracket, centre stay - exc: 2.0 V6	ABU106060
Bracket, centre stay - 2.0 V6	ABU140640
Cross member, front, all models	ABC140110

FRONT WING

All models, RH, up to 5D637208	ASB140080
All models, LH, up to 5D637208	ASB140090
All models, RH, from 5D637209 -	
exc: MG ZS body kit option	ASB140080
All models, LH, from 5D637209 -	
exc: MG ZS body kit option	ASB140090
MG ZS, RH, body kit option, from 5D637208	ASB160020
MG ZS, LH, body kit option, from 5D637208	ASB160030

GRILLE

Bright, up to 5D637208 -	
exc: MG ZS	DHB102690MMM
MG ZS, Primer/Chrome,	
up to 5D637208	DHB000050LZW
MG ZS, Le Mans/Bright,	
up to 5D637208	DHB000050WRB
MG ZS, Tahiti Blue/Bright,	
up to 5D637208	DHB000050JAO
MG ZS, Pearl Black/Chrome,	
up to 5D637208	DHB000050PBY
All models, from 5D637209 -	
exc: MG ZS	DHB000450LML
MG ZS, from 5D637209	DHB000440LML

COLLISION PARTS - REAR

MG ZS / ROVER 45 (JUNE 1999 ON)

BUMPER

All models, 4 door, up to 5D637208	DQB102480LML-R1
All models, 5 door, up to 5D637208	DQB102490LML-R1
All models, 4 door, primed, from 5D637209 -	
exc: exhaust finisher, parking aid	DQB001720LML
All models, 4 door, primed, with parking aid, from 5D637209 -	
exc: exhaust finisher	DQB001720LML
MG ZS, 4 door, primed, exhaust finisher, from 5D637209 -	
exc: parking aid	DQB001720LML
MG ZS180, 4 door, primed, exhaust finisher, from 5D637209 -	
exc: parking aid	DQB001720LML
MG ZS, 4 door, primed, exhaust finisher, parking aid,	
from 5D637209	DQB001720LML
All models, 5 door, primed, from 5D637209 -	
exc: exhaust finisher, parking aid	DQB001780LML
All models, 5 door, primed, parking aid, from 5D637209 -	
exc: exhaust finisher	DQB001781LML
MG ZS, 5 door, exhaust finisher, from 5D637209 -	
exc: parking aid	DQB001781LML
MG ZS180, 5 door, exhaust finisher, from 5D637209 -	
exc: parking aid	DQB001810LML
MG ZS180, primed, exhaust finisher, parking aid,	
from 5D637209	DQB001830LML

REAR PANEL

Rear panel assembly,	
4 door	AQA160010
5 door	AQA140010
Cross member, rear bumper mounting,	
4 door	AQC160020
5 door	AQC140010



PRICES
SEE PAGES 124-151
OR VISIT OUR
WEBSITE

MG ZS / ROVER 45 (JUNE 1999 ON)



MG ZS / ROVER 45



BRIGHT LEATHER GEAR KNOB -
UKJ100570LNF

STYLING

MG ZS / ROVER 45 (JUNE 1999 ON)

CHROME DOOR MIRROR COVERS (pair) <i>All models</i>	CRC100960MMM
REAR DOOR SILL COVERS <i>All models</i>	EBN100020MMM
BOOT SPOILER (Anthracite) 4 Door From YD471064 To 4D627495	DFD101690LML
GEAR LEVER GAITER/FINISHER , Rosewood Foil, Auto Rover Models from 3D603411 To 5D637209 Tecnik 1/Black, Auto Rover Models From 3D603411 Technical Grey, Auto MG Models From 5D637209	FJV107000AFM FJV107000MVT FJL000810LFD

BRIGHT LEATHER GEAR KNOB <i>MG models</i>	UKJ100570LNF
MG LOGO 'TOURING' GEAR KNOB <i>MG models</i>	RP1100
COMPETITION PEDAL SET <i>All models</i>	RP1095
MG TAX DISC HOLDER (available in silver or black) <i>MG models</i>	RP1097
ANTI THEFT AERIAL (various colours available) <i>All models</i>	RP1096

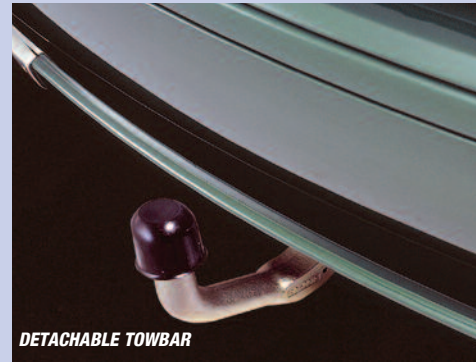

DETACHABLE TOWBAR

TOURING

MG ZS / ROVER 45 (JUNE 1999 ON)

TOWING MIRROR <i>All models</i>	CRB108270
DETACHABLE TOWBAR 4 Door up to 5D632708 5 Door up to 5D632708 4 Door from 5D632709 5 Door from 5D632709	KNB100690 KNB100670 XPT000117ACA XPT000117ACB
CYCLE CARRIER for use with towbar with 13 pin electrics <i>All models</i> 9 pin electrics <i>All models</i>	VUB111910 VUB111900
ROOF CROSS BARS <i>All models</i>	CAB000100PMA
SKI CLIPS (pair) for use with Roof Bars	CAN10005
TRAILER / REAR LIGHTING BOARD 4 ft Inc cable	RX1513
6 CD AUTO CHANGER New Rover Models Reconditioned Rover Models	XQE100270 XQE100250R
ESSENTIALS XTRA KIT	XPT000138ACA
INTERIOR CARE XTRA KIT	XPT000139ACA
ESSENTIALS & INTERIOR CARE KIT Includes XPT000138ACA & XPT000139ACA.	RP1017
POWER SOURCE INVERTER - converts 12V DC into 240V AC 150 watt model 300 watt model 500 watt model	RX1551-150 RX1551-300 RX1551-500

NOTES

SAFETY

MG ZS / ROVER 45 (JUNE 1999 ON)

EXTERIOR TEMPERATURE WARNING KIT	VUB100230
HEATED WASHER JET CONVERSION KIT	VUB100220
FIRE EXTINGUISHER 600gm Red Alloy Red, Powder, 1Kg	S3SSFE1 GAC9904X
PARKING AID OE KIT 4 Door up to 5D637208	VUB104430
PARKING AID UNIVERSAL KIT Including 4 sensors and all fittings.	RX1559
WARNING TRIANGLE Universal	RX1344
SAFETY VEST (luminous)	GAC2999

LITERATURE

MG ZS / ROVER 45 (JUNE 1999 ON)

OWNERS HANDBOOKS <i>Rover models</i> vin 552307 to vin 597440 vin 597441 to vin 602127 vin 602128 to vin 612917 vin 612918 to vin 637208 vin 637209 on	VDC000160EN VDC000380EN VDC000410EN VDC000500EN VDC000600EN
<i>MG models</i> vin 552307 to vin 597440 vin 602128 to vin 612917 vin 612918 to vin 637208 vin 637209 on	VDC000170EN VDC000440EN VDC000510EN VDC000610EN
HAYNES WORKSHOP MANUAL 45 & MGZS 1999-2005	RP1053
HAYNES "MAN" MANUAL - 128 pages, Health Guide in style of Workshop Manual	RX1534
HAYNES MANUAL PLASTIC PROTECTOR	RX1569

WHEELS & FITTING

MG ZS / ROVER 45 (JUNE 1999 ON)

MG BADGED VALVE CAPS <i>MG models</i>	RRF100060
MG BADGED ANTI THEFT VALVE CAPS <i>MG models</i>	RRF100060PAT
WHEEL CLEANING BRUSH (Fir Tree Shape)	KACB101
CONCOURS ALLOY WHEEL CLEANING KIT	RX1405
AUTOGLYM CLEAN WHEELS Alloy Wheel Cleaner 500ml	RX1322
AUTOGLYM ALLOY WHEEL SEAL 450ml	RX1443
AUTOGLYM INSTANT TYRE DRESSING	RX1368
RIMWAX Professional Wheel Polish and Sealer	RX1262
TYRE WELD Puncture Repair (Holts Brand) 300ml 400ml	GAC9903X-300ML GAC9903X-400ML
DIGITAL TYRE PRESSURE GAUGE	XPT000006ACA
TYRE TREAD DEPTH GAUGE	27298



CYCLE CARRIER - VUB111910



DOOR WIND DEFLECTORS -
VUB104650



MG LOGO FABRIC MAT SET -
EAH000820PPA



MGB

PRICES
SEE PAGES 124-151
OR VISIT OUR
WEBSITE



SERVICE PARTS

MGB

AIR FILTER All Models	PHE001003EVA
K & N PERFORMANCE AIR FILTER - Ribbed Aluminium Top (1 Required) All Models	RP1140
FUEL FILTER All Models	GFE7004
OIL FILTER Paper Element Type	GFE102
Spin On Canister Type	12H3274EVA
DISTRIBUTOR CAP 25D Distributors (Side Entry)	GDC102P
25D Distributors (Top Entry)	NJD000110EVA
45D Distributors	NJD000143EVA
ROTOR ARM 25D Distributors	GRA101
45D Distributors	59321324EVA
CONTACT SET 25D Distributors	GCS101
45D Distributors	RTC364EVA
CONDENSER 25D Distributors	GSC111
45D Distributors	GSC109
COIL 1962-1974 (Non Ballasted)	13H8213EVA
1975-1980 (Ballasted)	ADU8116EVA
HT LEAD SET 25D Distributors (Side Entry)	GHT102
25D Distributors (Top Entry)	NGC000106EVA
45D Distributors	GHT184P
SPARK PLUG All Models	GSP4462
FAN BELT Mechanical Fan	GCB10900
Electric Fan	GCB10950
FUEL PUMP Roadster 1962 To 1964	AZX1331
Roadster From 1964 & All GT's	AZX1311

ENGINE PARTS

MGB

ALLOY ROCKER COVER (Polished) All Models	RP1134 POLISHED
ALLOY ROCKER COVER FITTING KIT ALL MODELS	RP1134FK
ROCKER COVER GASKET All Models	12H3700EVA
HEAD GASKET SET All Models	AJM1163EVA
ENGINE MOUNTING RH From 1962 To 1974 (Chrome Bumper Models)	BHH1351P
LH From 1962 To 1974 (Chrome Bumper Models)	BHH1352P
RH & LH From 1974 (Rubber Bumper Models)	BHH1621P
ACCELERATOR CABLE From 1962 To 1974	AHH8462P
From 1975	BHH1648P

BRAKING

MGB

BRAKE DISC (Front) All Models - exc: V8 Models	BTB387
V8 Models	BTB1319
BRAKE PADS (Front) All Models - exc: V8 Models	SFC000202EVA
V8 Models	GBP242
'GREENSTUFF' KEVLAR BRAKE PADS (Front) All Models	SFC000202GS
BRAKE SHOES (Rear) All Models	SMN000740EVA
WHEEL CYLINDER (Rear) GT up to 1967 & All Roadsters	17H8735EVA
GT from 1968	SML001122EVA
WHEEL CYLINDER REPAIR KIT (Rear) GT up to 1967 & All Roadsters	519059
GT from 1968	8G8741
BRAKE HOSE Front up to 1978	GBH158P
Chrome Bumper (Single Line Hydraulic System)	GBH172
Front up to 1978	GBH172
Rubber Bumper (Single Line Hydraulic System)	GBH172
Front from 1978 (Dual Line Hydraulic System)	SHB000159EVA
Rear All Models	
BRAIDED STAINLESS STEEL BRAKE HOSE SET All Models	RP1144
BRAKE MASTER CYLINDER Single Line Hydraulic System	SJC000150EVA
Dual Line Hydraulic System	SJC000164EVA

CLUTCH

MGB

CLUTCH KIT (Cover, Plate & Bearing) All Models - exc: V8 Models	GCK109
V8 Models	GCK3308
CLUTCH MASTER CYLINDER Up To 1967	AHH6553P
From 1968	STC001007EVA
CLUTCH SLAVE CYLINDER All Models	BMK192EVA

COOLING & HEATING

MGB

THERMOSTAT 74C	GTS102
82C	GTS104
88C	GTS106
THERMOSTAT GASKET All Models	12G330EVA
WATER PUMP 1962-1965	PEB000115EVA
1965-1971	GWP114P
From 1971	GWP130P
V8 Models	GWP310
RADIATOR From 1962 To 1967	ARH260
From 1967 To 1976	NRP1142P
High Flow From 1967 To 1976	NRP1142UR
From 1976	NRP1154P
High Flow From 1976	NRP1154UR
V8 Models	NRP1059
TOP HOSE From 1962 To 1976	PCH000305EVA
From 1976	GRH592
BOTTOM HOSE From 1962 To 1971 Pump to Elbow	FMK8859
From 1962 To 1971 Elbow to Radiator	PCH000305EVA
From 1971 To 1976	PCH000498EVA
From 1976	PCH000641EVA
RADIATOR CAP 7 PSI	GRC102
13 PSI	PCD001111EVA
OIL COOLER 13 Row	ARA221
HEATER VALVE All Models	BHA5298
KENLOWE ELECTRIC FAN V8 Models	RP1184

ELECTRICAL

MGB

DYNAMO 1962-1967	GXE3101
ALTERNATOR From 1968 Separate Regulator Box (Fitted to some vehicles in 1968 Only)	37H2245R
From 1968 ACR Alternator	589715E
ALTERNATOR REGULATOR BOX For 37H2245R	BHA4789
WIPER MOTOR 1962 to 1967	GXE7714
From 1967	216148E
TEMPERATURE TRANSMITTER All Models	YCB000101EVA
BRAKE LIGHT SWITCH 1962 to 1975 (Chrome Bumper Models)	C16062A
1975-1980 (Rubber Bumper Models)	BHA4675P
REVERSE LIGHT SWITCH All Models	BAU1074A
FLASHER UNIT Indicators All Models	13H4393EVA
Hazard Warning All Models	GFU2221

LIGHTING

MGB

HEADLAMP Sealed Beam	GLU132
RHD Up To 1969 (No Pilot Hole)	13H3471A
RHD From 1969 To 1976 (With Pilot Hole)	XAP109
Halogen RHD From 1976	
HALOGEN CONVERSION KIT (Includes 2 Headlamps & Bulbs)	RB7129
RHD (No Pilot Hole)	RB7129PILOT
RHD (With Pilot Hole)	BHM7058
HEADLAMP ADJUSTER KIT All Models	
HEADLAMP BOWL ASSEMBLY Plastic including Adjusters	\$5400
All Models With Sealed Beam Headlamps	
FRONT SIDE & INDICATOR ASSEMBLY 1962 to 1974 (Chrome Bumper Models)	UKC5992
FRONT INDICATOR ASSEMBLY From 1974	BHA5322P
REAR LAMP ASSEMBLY Up To 1969	BHA4175P
From 1969	BHA4973P
REVERSE LAMP ASSEMBLY All Models fitted with Reverse Lamps	AAU5510
NUMBER PLATE LAMP From 1962 to 1973 (Fitted On Over Rider)	BHA4283P
1974 (Fitted On Bumper)	BHA5301
From 1975 to 1976 Chrome	127916
2 Mounted Vertically Either Side of Number Plate	
From 1976 Black	83H335
2 Mounted Vertically Either Side of Number Plate	

SUSPENSION & STEERING

MGB

FRONT WHEEL BEARING KIT All Models	RFC001005EVA
SPAX TELESCOPIC SHOCK ABSORBER CONVERSION Front All Models	CK12
Rear All Models	CK22
FRONT LEVER ARM SHOCK ABSORBER All Models RH & LH New	GSA119
RH & LH Reconditioned	GSA119E
REAR LEVER ARM SHOCK ABSORBER All Models RH New	GSA168
LH New	GSA169
RH Reconditioned	GSA168E
LH Reconditioned	GSA169E
FRONT COIL SPRING Roadster	
From 1962 To 1974 (Chrome Bumper)	AHH6451P
From 1974 To 1975 (Rubber Bumper Models)	BHH1225P
GT	
1962 To 1974 (Chrome Bumper Models)	BHH1077P
From 1974 (Rubber Bumper Models)	BHH1225P
REAR LEAF SPRING Roadster	
1962 To 1974 (Chrome Bumper Models)	GSV1006P
From 1975 (Rubber Bumper Models)	BHH1779P
GT	
1965 To 1974 (Chrome Bumper Models)	AHC31P
From 1974 (Rubber Bumper Models)	BHH1767P
WISHBONE BUSH Inner (4 Required Per Side) All Models Exc. V8	AHH7933
WISHBONE BUSH SET (8) All Models Exc. V8	AHH7933K
POLYURETHANE BUSH Car Set Chrome Bumper Models	RP1138
Rubber Bumper Models	RP1139
KING PIN KIT Axle Set All Models	RBK000301EVA
ANTI ROLL BAR LINK RH Front All Models	AHH6543A
LH Front All Models	AHH6544A
STEERING RACK Reconditioned From 1962 To 1974 (Chrome Bumper Models)	GSR3359E
From 1974 (Rubber Bumper Models)	BHH1848E
STEERING RACK GAITER KIT All Models	TDR001155EVA
TRACK ROD END All Models	RBK000168EVA
TIE ROD All Models	17H8713
WIRE WHEEL - Chrome Standard 14 x 4.5 60 Spoke	XW515C
HUB CONVERSION KIT For Wire Wheels With 2 Eared Spinners	
All Models Up To 1966 (Banjo Axle)	RP1145
All Models From 1966 (Tube Axle)	RP1136
With Octagonal Spinners	
All Models Up To 1966 (Banjo Axle)	RP1146
All Models From 1966 (Tube Axle)	RP1137



PRICES
SEE PAGES 124-151
OR VISIT OUR
WEBSITE

MGB



MGB



BODY REPAIR PANELS

MGB

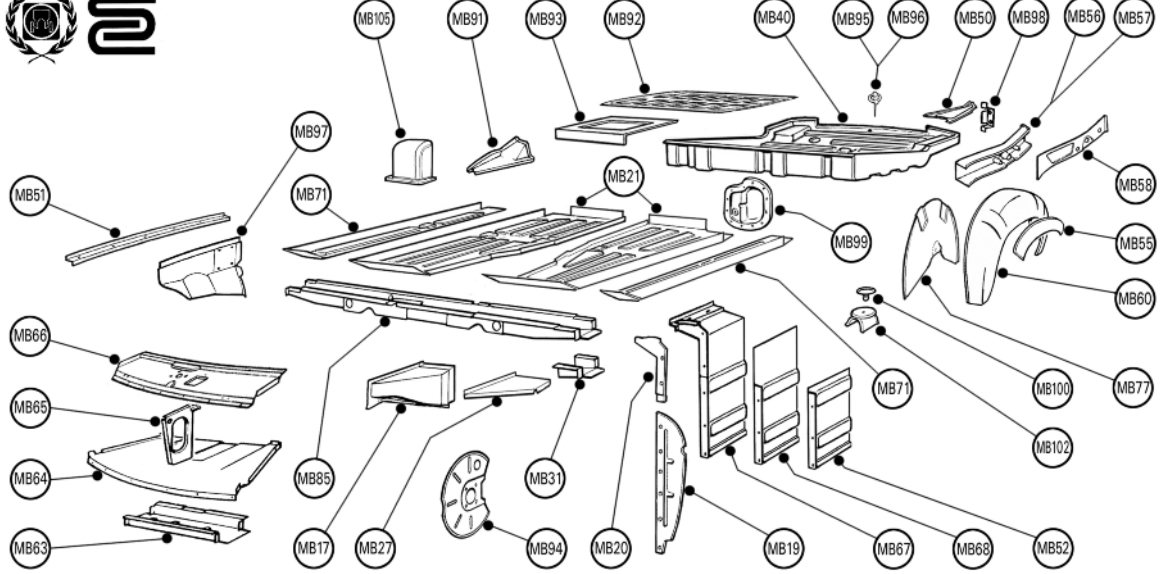

MB10	MB10	Frt Valance No Vents To 1972	MB32	MB32	Jacking Point	MB59	MB59L	B Post Lower Repair LH
MB101	MB101	Rr Wing End Below Lamp (Ch)	MB33	MB33L	Door Skin LH	MB59R	MB59R	B Post Lower Repair RH
MB104	MB104L	Finisher Door Face GT LH	NI	HZA567	Door Skin RH	MB61	MB61	Body Rr Lower Rubber Tourer
	MB104R	Finisher Door Face GT RH	NI	HZA566	Door Skin LH - Genuine	MB62	MB62	Body Rr Lower Rubber GT
MB11	MB11	Frt Valance With Vent Holes	MB36	MB36L	Door Skin RH - Genuine	MB70	MB70L	Mtg Brkt Window Channel LH
MB12	MB12	Front Valance Rubber	MB37	MB37L	Rr Wing Repair Frt Lwr LH	MB72	MB72	Mtg Brkt Window Channel RH
MB15	MB15L	Frt Wing Lower LH		MB37R	Rr Wing Repair Frt Lwr RH	MB73	MB73	Frt No Plate Backing UK
	MB15R	Frt Wing Lower RH	MB41	MB41	Rear Wing Repair Lwr Half LH	MB73	MB72S	Frt S/S No Plate Backing UK
MB16	MB16L	Frt Wing Lwr Repair LH	MB45	MB45	Rear Wing Repair Lwr Half RH	MB74	MB73S	Number Plates
	MB16R	Frt Wing Lwr Repair RH	MB46	MB46L	Rr Valance Lwr Half Chrome	MB75	MB74	Rr S/S No Plate Backing Chrome
MB22	MB22L	Step Sill Repair (4ft) LH	MB47	MB46R	Rr Valance Lwr Half Rubber	MB76	MB75	Number Plate
	MB22R	Step Sill Repair (4ft) RH	MB48	MB47	Door Bottom Repair LH	MB76	MB75S	Rr S/S No Plate Backing GT R/B
MB23	MB23L	Sill Closing Panel LH	MB49	MB48R	Door Bottom Repair RH	MB86	MB76	Body Rr Lower Chrome GT
	MB23R	Sill Closing Panel RH	MB49	MB47	Door Bottom Centre Repair	MB88	MB86SL	Rr Bumper Infill S/Steel LH
MB24	MB24L	Castle Rail LH	MB53	MB48L	Outer Sill LH	MB88	MB86SR	Rr Bumper Infill S/Steel RH
	MB24R	Castle Rail RH		MB48R	Outer Sill RH	MB89	MB88L	Window Channel LH
MB25	MB25	Castle Rail Repair 2ft Section		MB49/C	MGC S/Steel Tread Plate	MB90	MB88R	Window Channel RH
MB26	MB26L	Sill End Filler LH		MB49/GT	MGBGT S/Steel Tread Plate	NI	MB88R	S/S Retainer For Door Seal
	MB26R	Sill End Filler RH		MB49/MG	MG Logo S/Steel Tread Plate		MB89	B Post Assy LH
MB28	MB28L	S/Steel Over Sill LH		MB49/MGB	MGB S/Steel Tread Plate		MB90L	B Post Assy RH
	MB28R	S/Steel Over Sill RH		MB49/V8	V8 S/Steel Tread Plate		MB90R	Bonnet - Genuine
MB29	MB29	S/Steel Finisher Strip		MB53	Body Rr Lower Chrome Tourer		HZA4014	
MB30	MB30	Reinf Jacking S/Member						



MGB

PRICES
SEE PAGES 124-151
OR VISIT OUR
WEBSITE



BODY REPAIR PANELS
MGB

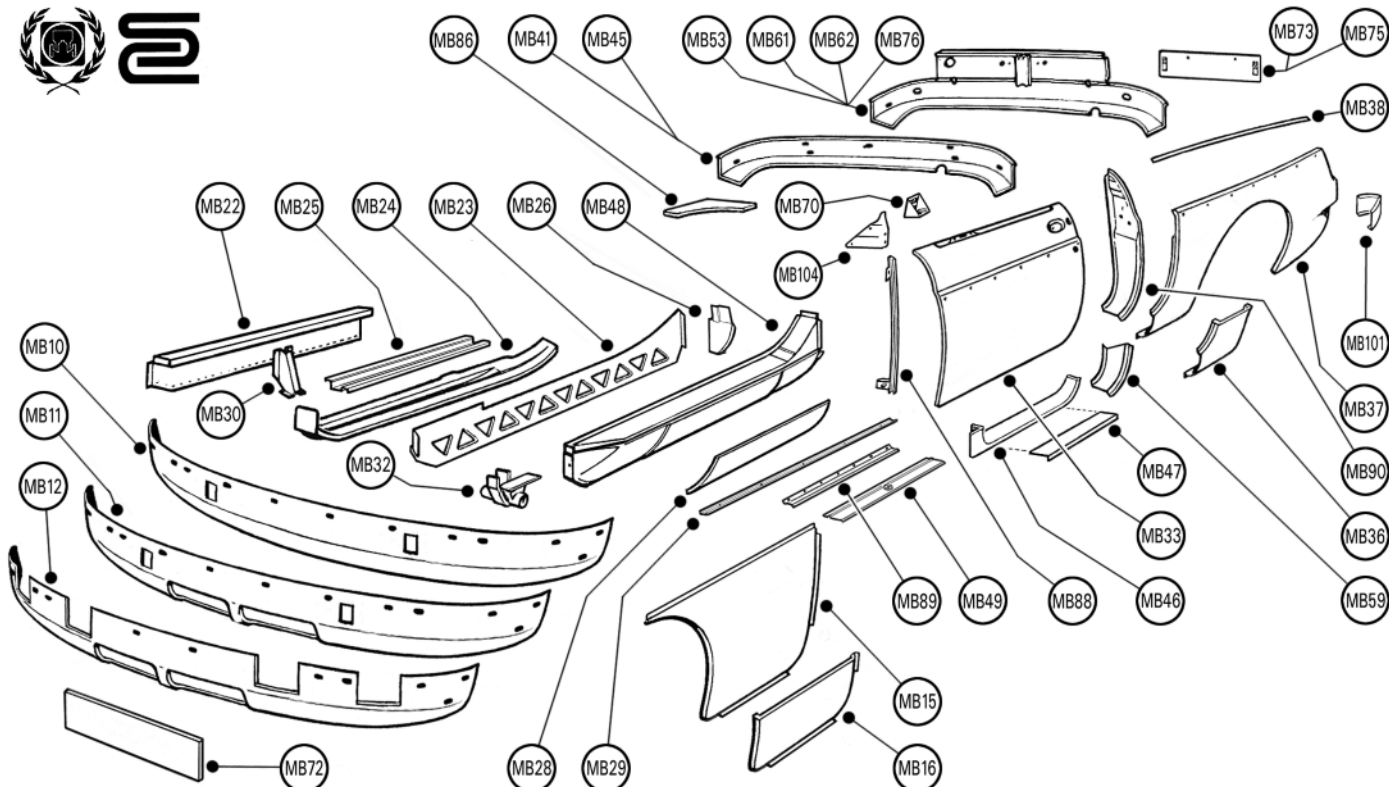

- MB100 **MB100** S/Member Bump Stop Mtg
- MB102 **MB102** Rear Axle Pedestal.
- MB105 **MB105** Pedal Box Cover Chrome
- MB17 **MB17L** Reinf W/Arch To Pedal Box LH
- MB17R** Reinf W/Arch To Pedal Box RH
- MB19 **MB19L** Splash Plate Painted LH
- MB19R** Splash Plate Painted RH
- MB19SL** Splash Plate S/Steel LH
- MB19SR** Splash Plate S/Steel RH
- MB20 **MB20L** Splash Shield Flange LH
- MB20R** Splash Shield Flange RH
- MB21 **MB21AL** Floor Panel 4 Sync LH 67-on
- MB21AR** Floor Panel 4 Sync RH 67-on
- MB21CL** Floor Assy 4 Synchro LH
- MB21CR** Floor Assy 4 Synchro RH
- MB21L** Floor Panel 3 Sync LH 62-67
- MB21R** Floor Panel 3 Sync RH 62-67
- MB27 **MB27L** Top Repair Plate For MB17 LH
- MB27R** Top Repair Plate For MB17 RH
- MB31 **MB31** X Member End Repair
- MB40 **MB40** Boot Floor
- MB50 **MB50L** Boot Floor Outer LH
- MB50R** Boot Floor Outer RH

- MB51 **MB51** Front Wing Top Repair
- MB52 **MB52L** Dash Side Lwr Repair LH
- MB55 **MB52R** Dash Side Lwr Repair RH
- MB55L** Rr W/Arch Outer Repair LH
- MB55R** Rr W/Arch Outer Repair RH
- MB56 **MB56L** Rr Chassis Rr Rep. Chrome LH
- MB56R** Rr Chassis Rr Rep. Chrome RH
- MB57 **MB57L** Rr Chassis Rr Rep. Rubber LH
- MB57R** Rr Chassis Rr Rep. Rubber RH
- MB58 **MB58AL** Clsg Rr S/Member Rubber LH
- MB58AR** Clsg Rr S/Member Rubber RH
- MB58L** Clsg Rr S/Member Chrome LH
- MB58R** Clsg Rr S/Member Chrome RH
- MB60 **MB60L** Rr W/Arch Outer LH
- MB60R** Rr W/Arch Outer RH
- MB63 **MB63** Support Radiator Duct
- MB64 **MB64** Radiator Duct
- MB65 **MB65** Reinf Bonnet Lock P/Form
- MB66 **MB66** Bonnet Lock Platform
- MB67 **MB67L** Dash Side 14inch LH
- MB67R** Dash Side 14inch RH
- MB68 **MB68L** Dash Side Side Repair LH
- MB68R** Dash Side Side Repair RH

- MB71 **MB71L** Floor Outer Repair LH
- MB71R** Floor Outer Repair RH
- MB77 **MB77** Rr Inner W/Arch Repair
- MB85 **MB85** Cross Member Centre
- MB91 **MB91L** Heelboard Ext LH
- MB91R** Heelboard Ext RH
- MB92 **MB92** Battery Cover Twin 6 Volt
- MB93 **MB93** Battery Cover One 12 Volt
- MB94 **MB94L** Painted Cover Disc Brake LH
- MB94R** Painted Cover Disc Brake RH
- MB94SL** S/Steel Cover Disc Brake LH
- MB94SR** S/Steel Cover Disc Brake RH
- MB95 **MB95** Spare Wheel Clamp Rostyle
- MB96 **MB96** Spare Wheel Clamp Wire Wheel
- MB97 **MB97L** Frt Inner Wing Repair LH
- MB97R** Frt Inner Wing Repair RH
- MB98 **MB98** Rr Exh Mtg Brkt
- MB99 **MB99** Axle Differential Cover (Tube)



BUMPERS

MGB

BUMPER Chrome Bumper Models

- Front **AHH6208**
- Rear **AHH6261**

BUMPER BOLT KIT Chrome Bumper Models

- Front **AHH6208BK**
- Rear **AHH6261BK**

BUMPER COVER Rubber Bumper Models

- Front **BHM536**
- Rear **BHM537**

NOTES

LITERATURE & MISC

MGB

TREAD PLATE TRIMS 'MGB Laurel' All Models **RP1135**

HAYNES WORKSHOP Manual All Models **RP1142**

HAYNES MANUAL PLASTIC PROTECTOR ALL MODELS **RX1569**

BRITISH MOTOR HERITAGE SPECIAL

TUNING DATA DVD All Models **HMCC2006DVD**

BRITISH MOTOR HERITAGE DVD

Includes Parts & Workshop Manuals & Owners Handbook.

MGB From 1962 To 1969 **HMCC3005DVD**

MGB From 1970 To 1974 **HMCC3006DVD**

MGB From 1974 To 1980 **HMCC3007DVD**

MGB GT V8 & MG RV8 **HMCC3008DVD**



PRICES
SEE PAGES 124-151
OR VISIT OUR
WEBSITE

MG MIDGET / AUSTIN HEALEY SPRITE



MG MIDGET / AUSTIN HEALEY SPRITE

SERVICE PARTS

MG MIDGET / AUSTIN HEALEY SPRITE

AIR FILTER 1098/1275CC 1500CC	PHE001004EVA GFE1063
K&N PERFORMANCE AIR FILTER (2 Required) 1098/1275CC 1500CC	RL1397 RL1377
OIL FILTER 1098CC Paper Element Type 1098CC Spin On Canister Type 1275CC 1500CC	LPZ000103EVA 12G2400SLP 12G2400SLP GFE119
DISTRIBUTOR CAP 1098/1275CC (Side Entry Type) 1098/1275CC (Top Entry Type) 1500CC (Top Entry Type)	GDC102P NJD000110EVA NJD000143EVA
ROTOR ARM 1098/1275CC 1500CC	GRA101 59321324EVA
CONTACT SET 1098/1275CC 1500CC	37H4414EVA RTC364EVA
CONDENSER 1098/1275CC 1500CC	GSC111 GSC118
COIL 1098/1275CC (Non Ballasted) 1500CC (Ballasted)	13H8213EVA ADU8116EVA
HT LEAD SET 1098CC 1275CC - Up To 1967 1275CC - From 1967 1500CC	NGC10011EVA NGC10011EVA GHT102 ERC3256P
SPARK PLUG 1098/1275CC 1500CC	GSP4362 GSP4382
FAN BELT 1098CC 1275CC Up To 1972 (Vehicles fitted with Dynamo) From 1972 to 1973 (Vehicles fitted with Alternator) From 1973 (Vehicles Fitted With Alternator) 1500CC	2D10A0865C 2D10A0865C ADU4237EVA GCB10813 GCB11088
FUEL PUMP Mechanical Up To 1963 Electric From 1964 To 1975 (Positive Earth) Electric From 1964 To 1975 (Negative Earth) Mechanical From 1975	17H98 AUF214EP AUF214 RKC1624

ENGINE CONTROLS

MG MIDGET / AUSTIN HEALEY SPRITE

ACCELERATOR CABLE 1098/1275CC 1500CC	AHA5746P CHA405P
---	-----------------------------------

BRAKING

MG MIDGET / AUSTIN HEALEY SPRITE

BRAKE DISC - Front Models Fitted With Steel Wheels Models Fitted With Wire Wheels	BTA383 BTA469
TURBO GROOVE' GROOVED & DIMPLED BRAKE DISC - Front Models Fitted With Steel Wheels	BTA383UR
ROSSINI' GROOVED & CROSS DRILLED DISCS - Front Models Fitted With Steel Wheels	BTA383 ROS
BRAKE PADS - Front All Models Fitted With Disc Brakes	GBP281
'GREENSTUFF' KEVLAR BRAKE PADS - Front All Models Fitted With Disc Brakes	GBP281 GS
BRAKE SHOES - Rear 1098CC (Single acting Piston Type) Wheel Cylinder 1098CC (Double acting Piston Type) Wheel Cylinder 1275CC/1500CC	SMN000819EVA 8G8814EVA 8G8814EVA
BRAKE DRUM - Rear All Models	2A7168P
BRAKE HOSE Front All Models fitted with Disc Brakes Rear All Models	SHB000157EVA GBH158P

WHEEL CYLINDER - Rear Single acting Piston Type Up To Chassis No.s HAN6 20544 (Sprite)/GAN1 13554 (Midget) Double acting Piston Type Vehicles Fitted With Front Drum Brakes Vehicles Fitted With Front Disc Brakes All Models From 1974	GWC1114 GWC1115P 17H8152EVA SML001129EVA
BRAKE MASTER CYLINDER 948 Drum Brake 1098 Disc Brake 1967 To 1977 1977 To 1978 From 1978	GMC109 GMC112E GMC151 GMC166 GMC170 GRK1020
BRAKE MASTER CYLINDER REBUILD KIT	GRK1020

CLUTCH

MG MIDGET / AUSTIN HEALEY SPRITE

CLUTCH KIT (Cover, Plate & Bearing) 1098CC 1275CC 1500CC	GCK260P GCK261P GCK160
CLUTCH MASTER CYLINDER 1275CC/1500CC	AAU2298P
CLUTCH MASTER CYLINDER REBUILD KIT	BAU1252
CLUTCH SLAVE CYLINDER 1098CC - 1275CC 1500CC	GSY113 GSY107

COOLING

MG MIDGET / AUSTIN HEALEY SPRITE

THERMOSTAT 74C 82C 88C	GTS102 GTS104 GTS106
THERMOSTAT GASKET All Models	12G330EVA
RADIATOR CAP 1098CC 1275CC Fitted With Vertical Flow Radiator 1275CC Fitted With Cross Flow Radiator (Cap Is On Seperate Expansion Tank) 1500CC (Cap Is On Separate Expansion Tank)	GRC101 GRC101 565540EVA 565540EVA
FILLER PLUG Models With Separate Expansion Tank	ARA2634
WATER PUMP 1098CC/1275CC up to 1968 1098CC/1275CC from 1968 1500CC	PEB000132SLP CAM4255SLP GWP128
BY PASS HOSE All Models	12A2178EVA
THERMAL TRANSMITTER 1500CC From 1978	GTR108
OIL COOLER 1500CC	ARA221
KENLOWE ELECTRIC FAN KIT 1098CC/1275CC	RP1185

ELECTRICAL

MG MIDGET / AUSTIN HEALEY SPRITE

DYNAMO Up To 1972	GXE3101
ALTERNATOR From 1972	589715E
WIPER MOTOR Up To 1969 From 1969	GXE7714 216148E
BRAKE LIGHT SWITCH 1098/1275CC 1500CC	XKB100090 BHA4675
REVERSE LIGHT SWITCH 1275CC 1500CC	13H4216 GAE191
FLASHER UNIT 3 Pin Type 2 Pin Type Hazard Warning 3 Pin Type 2 Pin Type	GFU103 GFU2124
OIL PRESSURE SWITCH 1500CC From 1978	C28520 154577EVA 88G563EVA
VOLTAGE REGULATOR Up To 1969 From 1969 To 1972	GEU6603 GEU6605
VOLTAGE STABILISER Up To 1978 From 1978	BHA4602 148876A

LIGHTING

MG MIDGET / AUSTIN HEALEY SPRITE

HEADLAMP - Sealed Beam RHD (No Pilot Hole) RHD (With Pilot Hole)	GLU132 13H3471A
HALOGEN CONVERSION KIT (Includes 2 Headlamps & Bulbs) RHD (No Pilot Hole) RHD (With Pilot Hole)	RB7129 RB7129PILOT BHM7058
HEADLAMP ADJUSTER KIT All Models	BHM7058
HEADLAMP BOWL ASSEMBLY Plastic Including Adjusters All Models	S5400
FRONT INDICATOR ASSEMBLY Sprite MK1 (Frog Eye) RH & LH Midget 1500 (UK Models)	121355 BHA5318
FRONT SIDE & INDICATOR ASSEMBLY RH (Exc. Germany/Italy) Sprite MK2/3/4, Midget MK1/2/3 LH (Exc. Germany/Italy) Sprite MK2/3/4, Midget MK1/2/3	216416 216417
REAR LAMP ASSEMBLY Sprite MK1 (Frog Eye) Sprite/Midget Up To 1969 (Exc.USA) Sprite/Midget From 1969 (Exc.USA)	13H23 BHA4175 BHA4973
REVERSE LAMP ASSEMBLY All Models Fitted With Reverse Lamps	AAU5510
NUMBER PLATE LAMP 1 Lamp fitted horizontally above number plate Up To 1969 From 1969 To 1975 2 Lamps Fitted Vertically Either Side Of Number Plate From 1975 (Chrome) From 1975 (Black)	127916 2A9119 127916 83H335



SUSPENSION & STEERING

MG MIDGET / AUSTIN HEALEY SPRITE

FRONT LEVER ARM SHOCK ABSORBER All Models RH New LH New RH Reconditioned LH Reconditioned	GSA102 GSA103 GSA102E GSA103E
'FRONTLINE' TELESCOPIC SHOCK ABSORBER CONVERSION - Front All Models	TMK30908
REAR LEVER ARM SHOCK ABSORBER All Models RH New LH New RH Reconditioned LH Reconditioned	GSA149 GSA150 GSA149E GSA150E
SPAX TELESCOPIC SHOCK ABSORBER CONVERSION Rear Up To 1964 Rear From 1964 To 1975 Rear From 1975	CK5 CK6 CK7
FRONT COIL SPRING From 1964 To 1975 From 1975	CHA129 CHA570
REAR LEAF SPRING From 1964 To 1975 (Semi Elliptic) From 1975	AHA8093 CHA493
STUB AXLE - Reconditioned Vehicles With Factory Fitted Disc Brakes (From 1963) RH LH	BTA744BE BTA745BE AHA7029
WISHBONE PAN	AHA7029
STEERING RACK Up to 1972 Reconditioned - up to 1972 Reconditioned - from 1972	BTA1096 ACG6010E AHA9956E



MG MIDGET / AUSTIN HEALEY SPRITE

PRICES
SEE PAGES 124-151
OR VISIT OUR
WEBSITE



BODY REPAIR PANELS MG MIDGET / AUSTIN HEALEY SPRITE

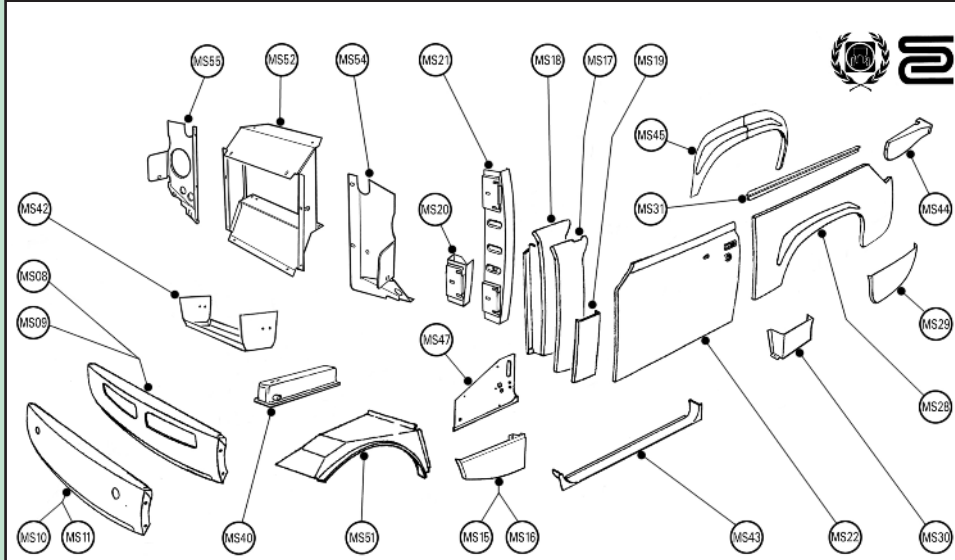

- | | | | | | |
|------|---------------|--------------------------------|------|--------------|------------------------------|
| MS08 | MS08 | Frt Valance Skin Rubber | MS29 | MS29L | Rr Lower Rear Wing Repair LH |
| MS09 | MS09 | Frt Valance Assy+ Stiff Rubber | MS29 | MS29R | Rr Lower Rear Wing Repair RH |
| MS10 | MS10 | Frt Valance Skin Chrome | MS30 | MS30L | Rr Wing Frt Lwr Repair LH |
| MS11 | MS11 | Frt Valance Assy+ Stiff Chrome | MS30 | MS30R | Rr Wing Frt Lwr Repair RH |
| MS15 | MS15L | Frt Wing Repair - 1962 - 71 LH | MS31 | MS31 | Rear Wing Beading 5.5 Ft |
| MS15 | MS15R | Frt Wing Repair - 1962 - 71 RH | MS40 | MS40L | Chassis Leg Frt Repair LH |
| MS16 | MS16L | Frt Wing Repair Rubber LH | MS40 | MS40R | Chassis Leg Frt Repair RH |
| MS16 | MS16R | Frt Wing Repair Rubber RH | MS42 | MS42 | Radiator Tray |
| MS17 | MS17L | Door Pillar Full Skin LH | MS43 | MS43L | Door Bottom Repair LH |
| MS17 | MS17R | Door Pillar Full Skin RH | MS43 | MS43R | Door Bottom Repair RH |
| MS18 | MS18L | Door Pillar + A Post Inner LH | MS44 | MS44L | Boot Floor To Wing LH |
| MS18 | MS18R | Door Pillar + A Post Inner RH | MS44 | MS44R | Boot Floor To Wing RH |
| MS19 | MS19 | Door Pillar Repair Lwr Half | MS45 | MS45L | Outer Wheel Arch Repair LH |
| MS20 | MS20L | Lower Hinge Repair LH | MS45 | MS45R | Outer Wheel Arch Repair RH |
| MS20 | MS20R | Lower Hinge Repair RH | MS47 | MS47L | Outer Footwell LH |
| MS21 | MS21AR | Inner A Post No Box RH | MS47 | MS47R | Outer Footwell RH |
| MS21 | MS21L | Inner A Post LH | MS51 | MS51L | Front W/Arch Outer LH |
| MS21 | MS21R | Inner A Post With Box RH | MS51 | MS51R | Front W/Arch Outer RH |
| MS22 | MS22L | Door Skin 1961 On LH | MS52 | MS52 | Radiator Cowling |
| MS22 | MS22R | Door Skin 1961 On RH | MS54 | MS54 | Rad Splash Shield LH |
| MS28 | MS28L | Lower Rear Wing LH | MS55 | MS55 | Rad Splash Shield RH |
| MS28 | MS28R | Lower Rear Wing RH | | | |

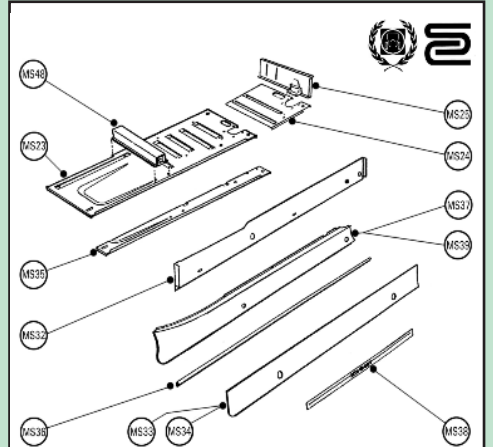

- | | | |
|------|-----------------|-----------------------------------|
| MS23 | MS23AL | 1/2 Floor Assy 1958 - 64 LH |
| | MS23AR | 1/2 Floor Assy 1958 - 64 RH |
| | MS23L | 1/2 Floor Assy 1964 On LH |
| | MS23R | 1/2 Floor Assy 1964 On RH |
| MS24 | MS24L | Rear Floor Repair 1964 On LH |
| | MS24R | Rear Floor Repair 1964 On RH |
| MS25 | MS25L | Bulkhead Repair LH |
| | MS25R | Bulkhead Repair RH |
| MS26 | MS26FR | Sill Closing Plate Pair RH |
| | MS26R | Sill Closing Plate Pair RH |
| | MS26RR | Sill Closing Plate Rear RH |
| MS27 | MS27FL | Sill Closing Plate Front LH |
| | MS27L | Sill Closing Plate Pair LH |
| | MS27RL | Sill Closing Plate Rear LH |
| MS32 | MS32L | Inner Sill Assy LH |
| | MS32R | Inner Sill Assy RH |
| MS33 | MS33L | S/S Oversill 2 JP LH |
| | MS33R | S/S Oversill 2 JP RH |
| MS34 | MS34L | S/S Oversill 1 Jacking Point LH |
| | MS34R | S/S Oversill 1 Jacking Point RH |
| MS35 | MS35L | Floor Repair O/S 6 LH |
| | MS35R | Floor Repair O/S 6 RH |
| MS36 | MS36 | S/S Strip for MS33/34 |
| MS37 | MS37L | Outer Sill 1 Jacking Point LH |
| | MS37R | Outer Sill 1 Jacking Point RH |
| MS38 | MS38/MID | S/S Plate Midget Logo |
| | MS38/SPR | S/S Plate Sprite Logo |
| MS39 | MS39L | Outer Sill 2 Jacking Point LH |
| | MS39R | Outer Sill 2 Jacking Point RH |
| MS48 | MS48 | X Member Repair inc Jacking Point |



WIRE WHEELS MG MIDGET / AUSTIN HEALEY SPRITE

- | | |
|---|-----------------|
| WIRE WHEELS | |
| Painted 4 x 13" 60 spoke | XW458S |
| Chrome 4 x 13" 60 spoke | XW458C-2 |
| HUB CONVERSION KIT - for Wire Wheels | |
| with 2 Eared Spinners | GAC7017 |
| with 2 Octagonal Spinners | GAC7027 |

LITERATURE & MISC MG MIDGET / AUSTIN HEALEY SPRITE

- | | |
|--|--------------------|
| HAYNES WORKSHOP MANUAL All Models | RP1141 |
| HAYNES MANUAL PLASTIC PROTECTOR | RX1569 |
| BRITISH MOTOR HERITAGE SPECIAL TUNING DATA DVD All Models | HMCC2006DVD |
| BRITISH MOTOR HERITAGE DVD | |
| Includes Parts & Workshop Manuals & Owners Handbook | |
| From 1957 To 1964 | HMCC1003DVD |
| From 1964 To 1974 | HMCC3009DVD |
| From 1974 to 1979 | HMCC3010DVD |

NOTES



PRICES
SEE PAGES 124-151
OR VISIT OUR
WEBSITE

ROVER 75 V8 / ZT260 (OCT 2003 ON)



SERVICE PARTS

ROVER 75 V8 / ZT260 (OCT 2003 ON)

AIR FILTERS All models standard K&N	PHE000100 PHE000100K&N
FUEL FILTERS All models	WFL000090
OIL FILTERS All models	LPW000070
POLLEN FILTERS All models	JKR000030
SPARK PLUGS Petrol, all models	NLP000120
WIPER BLADES windscreen wiper blade, driver windscreen wiper blade, passenger backlight wiper blade, Tourer	DKC100940 DKC100950 DKC000120
FUEL PUMPS All models	XNB000030
TIMING CHAINS All models	LHN000070
ALTERNATOR BELTS All models	PQS000300

BRAKING

ROVER 75 V8 / ZT260 (OCT 2003 ON)

BRAKE DISC , each All models front - standard front - uprated rear	SDB000420 SDB000420UR SDB000980
BRAKE PADS , (1 Set) All models front - standard front - uprated rear	SFP000040 SFP000040UR SFP000380 SFS000070
HANDBRAKE SHOES , rear (1Set) All models	SPB000520 SPB000530
HANDBRAKE CABLES All models, RH LH	

ENGINE

ROVER 75 V8 / ZT260 (OCT 2003 ON)

CAM SHAFT All Models, RH Head LH Head	LGC000560 LGC000570
--	--------------------------------------

CLUTCH

ROVER 75 V8 / ZT260 (OCT 2003 ON)

CLUTCH COVER All models	URB000470
CLUTCH PLATES All models	UQB000280

COOLING

ROVER 75 V8 / ZT260 (OCT 2003 ON)

RADIATORS All models	PCC000960SLP
THERMOSTATS All models	PEL000240
WATER PUMPS All models	PEB000130

ELECTRICAL

ROVER 75 V8 / ZT260 (OCT 2003 ON)

BATTERIES All models	YGD000120
-----------------------------	------------------

EXHAUST SYSTEM

ROVER 75 V8 / ZT260 (OCT 2003 ON)

CATALYTIC CONVERTERS - DOWNPIPES All models, RH LH	WCD001791 WCD001811
---	--------------------------------------

INTERMEDIATE ASSEMBLY*

Front All models	WCE000721P
Rear (over axle) Manual	WCE000711
Rear (over axle) Automatic	WCE000850

*Originally the Front & Rear (Over Axle) intermediate sections were in one piece therefore a clamp and sleeve may be required when fitting replacement sections.

CLAMP AND SLEEVE for Joining Intermediate Sections All Models	WCL000020
---	------------------

REAR ASSEMBLIES

Manual, saloon, RH	WDE000601
Manual, saloon, LH	WDE000591
Manual, tourer, RH	WDE000621
Manual, tourer, LH	WDE000611
Auto., saloon, RH	WDE000700
Auto., saloon, LH	WDE000690
Auto., tourer, RH	WDE000720
Auto., tourer, LH	WDE000710

LIGHTING

ROVER 75 V8 / ZT260 (OCT 2003 ON)

HEADLAMPS All models, RH LH Xenon Lamp, RH Xenon Lamp, LH Front fog lamp	XBC002630 XBC002640 XBC104000 XBC104010 XBJ000010
INDICATOR LAMPS All models, Bumper indicator Side repeater	XBD000010 XGB100310
REAR LAMPS Saloon, RH Saloon, LH Tourer, RH Tourer, LH	XFB000500 XFB000510 XFB000520 XFB000530
HEADLAMP BULBS Dip beam, H7, all models Dip beam, H7, blue vision H11-55W, Halogen, fog (Xenon lamps) Main beam, h1-55 Watt, all models Main beam, h9-55 Watt, all models Capless side lamp - Bulb-501, w10/5-5 Watt Side-light, blue vision - Bulb-501, w10/5-5 Watt, from 3D261240	XZQ000210 AZQ000020 XLQ000110 GLB448 XZQ000100 AFU4481
INDICATOR LAMP BULBS Yellow, direction indicator - Bulb-344, 21 Watt Orange, side repeater - Bulb-501, wy5 Watt	AZQ000030 XZQ100190L
REAR LAMP BULBS Clear, all models - Bulb-382, p25/1-21 Watt Yellow, direction indicator - Bulb-344, 21 Watt Rear fog, Saloon - Bulb-207, r19/55 Watt Capless clear, Tourer - Bulb-501, w10/5-5 Watt	XZQ100210L GLB382 XZQ100190L GLB207 AFU4481

STEERING & SUSPENSION

ROVER 75 V8 / ZT260 (OCT 2003 ON)

BALL JOINTS All models, RH LH	RBJ000761 RBJ000771
SHOCK ABSORBERS , front All models rear All models	RNB001080 RPD000580
TRACK ROD END RH All Models LH All Models	QJB100180 QJB100190
TRAILING ARM ASSEMBLY , rear All models, with bushes, RH LH	RGD000463 RGD000473
WHEEL BEARING KIT , front All models rear All models	RUD100120 RUD100120

COLLISION PARTS - FRONT

ROVER 75 V8 / ZT260 (OCT 2003 ON)

BONNET All models	BKA500130
BUMPERS All models, up to 4D321637 All models, from 4D321638	DPC000270LML DPB003000LML ACA500021
FRONT PANEL All models	ASB500020 ASB500030

COLLISION PARTS - REAR

ROVER 75 V8 / ZT260 (OCT 2003 ON)

REAR BUMPER Saloon, up to 4D321637 Saloon, from 4D321638 Tourer, up to 4D321637 Tourer, from 4D321638	DQC000041LML DQC001010LML DQC101531LML DQC001030LML
REAR PANEL Saloon Tourer	AQA500010 AQA500030

PROTECTION & STOWAGE

ROVER 75 V8 / ZT260 (OCT 2003 ON)

MUD GUARDS BLACK Front Pair All Models (exc. Where side sills are fitted)	CAS100730PMA
Rear Pair Saloon to August 2004 Tourer to August 2004	CAT100860PMA CAT101310PMA
MG LOGO FABRIC MAT SET RHD MG models LHD MG models	XPT000130ACA XPT000130ACB

STYLING

ROVER 75 V8 / ZT260 (OCT 2003 ON)

CHROME DOOR MIRROR COVERS (pair) All models	GRC100960MMM
COMPETITION PEDAL SET All models	RP1095
MG TAX DISC HOLDER (available in silver or black) MG models	RP1097
MG LOGO 'TOURING' GEAR KNOB MG models	RP1100
ANTI THEFT AERIAL (various colours available) All Models	RP1096

TOURING

ROVER 75 V8 / ZT260 (OCT 2003 ON)

TOWING MIRROR All models	CRB108270
SKI CLIPS (pair) for use with Roof Bars	CAN100140
ROOF RAIL (Runs along the length of the roof) RH Tourer All models LH Tourer All models	CAC000020PMA CAC000030PMA
BRACKETS (6 required) Tourer All models	CAX100170
BOLT (6 required) Tourer All models	FT106257MA
BOLT (12 required) Tourer All models	CYG100410
TRAFFICMASTER ECU All Models	XVS000030
TRAFFICMASTER CONNECTORS (3 Required) All Models	YPC116330
ESSENTIALS XTRA KIT	XPT000138ACA
INTERIOR CARE XTRA KIT	XPT000139ACA
ESSENTIALS & INTERIOR CARE KIT (includes XPT000138ACA & XPT000139ACA)	RP1017
POWER SOURCE INVERTER - converts 12V DC into 240V AC 150 watt model 300 watt model 500 watt model	RX1551-150 RX1551-300 RX1551-500
TRAILER / REAR LIGHTING BOARD 4ft Inc cable	RX1513





ROVER 75 V8 / ZT260 (OCT 2003 ON)

PRICES
SEE PAGES 124-151
OR VISIT OUR
WEBSITE



SAFETY

ROVER 75 V8 / ZT260 (OCT 2003 ON)

FIRE EXTINGUISHER

600 gm Red Alloy
Red, Powder, 1Kg

S3SSFE1
GAC9904X

PARKING AID UNIVERSAL KIT

including 4 sensors and all fittings All models

RX1559

HEATED WASHER JET CONVERSION KIT

All models

VUB102110

WARNING TRIANGLE Universal All Models

RX1344

SAFETY VEST (luminous)

GAC2999

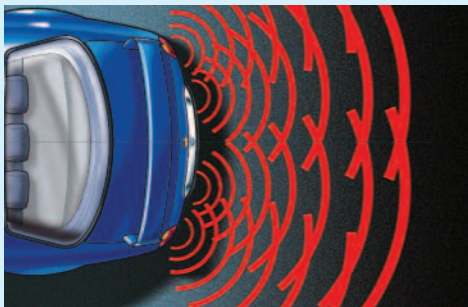

WHEELS & FITTINGS

ROVER 75 V8 / ZT260 (OCT 2003 ON)

MG BADGED VALVE CAPS MG models RRF100060

MG BADGED ANTI THEFT VALVE CAPS
MG models RRF100060PAT

WHEEL CLEANING BRUSH (Fir Tree Shape) KACB101

MWS WHEEL CLEANING KIT RX1405

AUTOGLYM ALLOY WHEEL SEAL 450ml RX1443

RIMWAX Professional Wheel Polish and Sealer RX1262

AUTOGLYM INSTANT TYRE DRESSING RX1368

TYRE WELD Puncture Repair (Holts Brand)

300ml GAC9903X-300ML

400ml GAC9903X-400ML

DIGITAL TYRE PRESSURE GAUGE XPT000006ACA

TYRE TREAD DEPTH GAUGE 27298

NOTES

LITERATURE

ROVER 75 V8 / ZT260 (OCT 2003 ON)

OWNERS HANDBOOKS MG To vin 00214 VDC000540EN

HAYNES "MAN" MANUAL - 128 pages,
Health Guide in style of Workshop Manual RX1534

HAYNES MANUAL PLASTIC PROTECTOR RP1016



ROVER 75 / ZT / ZT-T (JAN 1999 ON)

PRICES
SEE PAGES 124-151
OR VISIT OUR
WEBSITE



SERVICE PARTS

ROVER 75 / ZT / ZT-T (JAN 1999 ON)

SERVICE KIT

inc Air & Oil filters, Sump Plug Washer and 4 Sparkplugs
1.8 Petrol models RP1011

inc Air & Oil filters, Sump Plug Washer and 6 Sparkplugs
2.0/2.5 Petrol V6 models RP1060

inc Air/Oil/fuel/pollen filters and Sump Plug Washer
2.0 Diesel RP1064

inc Air/Oil/fuel filters and Sump Plug Washer
2.0 Diesel RP1065

AIR FILTERS

Petrol, all models PHE100461
2.0 Diesel PHE100500

PIPERCROSS INDUCTION KIT

2.5 Petrol V6 models XPT000180PXI

PIPERCROSS REPLACEMENT PANEL FILTER

(Fits in standard air box) 2.0 Diesel XPT000186PXP

K&N "GEN.2" INDUCTION KIT

Incs. Freeflow Intake Duct, Filter, Heat Shield & Cold Air Hose.
Rover 75/MGZT 2.5 V6 models RP1089

FUEL FILTERS

Petrol, all models WFL000090
2.0 Diesel WJI100000

OIL FILTERS

1.8 Petrol, all models LPW100181
2.0/2.5 Petrol V6 LPW100161
2.0 Diesel LRF100150

POLLEN FILTERS

All models JKRO00030
Odour Filter (Optional Extra) JKRO00040

GLOW PLUGS Diesel, all models

NCC100120

SPARK PLUGS

Petrol, all models - exc: LPG conversion NLP100290
Petrol, LPG conversion NLPO00090

WIPER BLADES

Blade - windscreen wiper, driver DKC100940
passenger DKC100950
Tourer, Blade - backlight wiper DKC000120

FUEL DELIVERY

Petrol, (in tank fuel pump)
up to 2D225075 WFX101160
from 2D225076 XNB000030

Diesel, dual pump system
up to 5D332300, (in tank fuel pump) WFX100933
up to 5D332300, (under bonnet fuel pump) WQB100482

Diesel, single pump system
from 5D332301, (in tank fuel pump) WFX000350

TIMING BELTS

1.8 Petrol, all models LHN100560
2.0/2.5 Petrol V6, front LHN100410
2.0/2.5 Petrol V6, rear LHN100420

TIMING BELT KIT

1.8 Petrol - all models (includes belt & tensioner) RP1078
2.0/2.5 Petrol V6 (includes belts & tensioner) RP1081

TIMING CHAIN

2.0 Diesel, lower MVF100070
2.0 Diesel, upper LHN100840

ALTERNATOR BELTS

1.8 Petrol, all models - exc: air-con PQS100840
1.8 Petrol, all models, air-con only PQS101180
2.0/2.5 Petrol V6 - exc: air-con PQS101262
2.0/2.5 Petrol V6, air-con only PQS101272
2.0 Diesel PQS101300

BRAKING

ROVER 75 / ZT / ZT-T (JAN 1999 ON)

BRAKE DISC

front each
All models - exc: 190 PS MG ZT/ZT-T SDB000880
MG ZT 190 PS / ZT-T 190 PS SDB000420

rear solid each
All Rover 75 models - exc 2.5 Tourer SDB000870
MG ZT & ZT-T models from 2D252352
exc: 180 & 190 PS SDB000870

rear vented each
Rover 75 2.5 Tourer SDB000010
MG ZT & ZT-T models from 2D252351 SDB000010

exc: 180 & 190 PS SDB000010
MG ZT & ZT-T 180 & 190 SDB000010

BRAKE PADS

front (1 Set)
All models - exc: 190 PS MG ZT/ZT-T SFP100511SLP
MG ZT 190 PS/ZT-T 190 PS SFP000040

rear All models SFP100520

WEAR INDICATOR LEAD

front SOM100030
rear SOE100010

HANDBRAKE SHOES, rear (1Set) All models

SFS100190SLP

HANDBRAKE CABLES

front, all models SPB101410
rear, up to VIN 280037 SPB101550
rear, from VIN 280038 SPB000230



ENGINE

ROVER 75 / ZT / ZT-T (JAN 1999 ON)

See "Electrical" for Diesel Power Box upgrades.

CYLINDER LINER

K Series & KV6 Engine Petrol Models LCJ000050SLP

SEALANT For Use when Fitting Cylinder Liner

K series Engine Models GGC102

CYLINDER HEAD BOLT

2.0 - 2.5 V6 Petrol LDN10027
1.8 Petrol WAM2293

HYDRAULIC VALVE TAPPET

2.0 - 2.5 V6 Petrol LGR000050

SEAL - camshaft oil

Black, front 1.8-2.0-2.5 Petrol LUC100290SLP
Red, rear 1.8-2.0-2.5 Petrol LUC100220SLP

CYLINDER HEAD GASKET

2.0 & 2.5 V6 Petrol LVB101630

TURBO CHARGER 2.0 Diesel

PMF100520

OIL PUMP ASSEMBLY

1.8 Petrol - Inc. Turbo LPF000030
2.0 & 2.5 V6 Petrol LPF101290SLP

CLUTCH

ROVER 75 / ZT / ZT-T (JAN 1999 ON)

CLUTCH COVER

1.8/2.0 Petrol V6 - exc: 1.8 Turbo URB100702
1.8 Turbo Petrol URB100851
2.0 Diesel URB100652
2.5 Petrol V6 URB100851

CLUTCH PLATES

1.8 Petrol - exc: 1.8 Turbo UQB100973
1.8 Turbo Petrol UQB000380
2.0/2.5 Petrol V6 UQB000380
2.0 Diesel UQB000380

CLUTCH RELEASE BEARINGS (Includes Slave Cylinder)

All models - exc: 2.0 Diesel UUB100193
2.0 Diesel UUB105301

CLUTCH KIT (Includes Plate & Cover)

1.8 Petrol - exc: 1.8 Turbo RP1066
2.0 Petrol V6 RP1067
2.5 Petrol V6 RP1068
2.0 Diesel RP1069

FLYWHEEL 2.5 Petrol V6

PSD103252

CLUTCH MASTER CYLINDER

Petrol RHD STC100146
2.0 Diesel RHD STC105480



PRICES
SEE PAGES 124-151
OR VISIT OUR
WEBSITE

ROVER 75 / ZT / ZT-T (JAN 1999 ON)



COOLING

ROVER 75 / ZT / ZT-T (JAN 1999 ON)

RADIATORS All models **PCC000960SLP**

COOLING FAN MOTOR

V6 & All 4 Cyl. Petrol
2.0 Diesel

PGJ000100
PGJ000110

KENLOWE FAN KIT

14" Fan Usual Fitment -

1.8 non Air Con. Non Turbo

Dependant on Vehicle use and Ambient Conditions

(please confirm at time of ordering)

RP1117-14

17" Fan Usual Fitment - 2.0/2.5 V6 & Diesel

Dependant on Vehicle use and Ambient Conditions

(please confirm at time of ordering)

RP1117-17

THERMOSTATS

1.8 Petrol -exc: 1.8 Turbo

1.8 Turbo Petrol

2.0 Diesel

2.0/2.5 Petrol V6 (with housing)

PEL10016

PEL000170

PEL100570

PEM101050

WATER PUMPS

1.8 Petrol, all models

2.0 Diesel

2.0/2.5 Petrol V6

PEB102510SLP

PEB102470

PEB102240

RIGID COOLANT PIPE - Thermostat to Bottom Hose

1.8 Petrol

PEP102650

ELECTRICAL

ROVER 75 / ZT / ZT-T (JAN 1999 ON)

BATTERIES

1.8 Petrol, manual

1.8 auto./2.0/2.5 Petrol

2.0 Diesel

ZUA000027E

ZUA000096E

ZUA000096E

AIR FLOW METER 2.0 Diesel

MHK101130

HT LEAD SET 2.0 & 2.5 V6 Petrol

NGC000020

POWER BOX DIESEL UPGRADE

Simply plug in, improves power & torque.

Potential for improved economy also.

2.0 CDTi (130BHP) From VIN prefix 'YA'

2.0 Diesel (116 BHP) From VIN Prefix 'YA'

RP1114

RP1115

FUEL SYSTEM

ROVER 75 / ZT / ZT-T (JAN 1999 ON)

FUEL INJECTOR

1.8 Petrol

2.0 Diesel

MJY100550

MKG100270

TURBO CHARGER 2.0 Diesel

PMF100520

EXHAUST SYSTEM

ROVER 75 / ZT / ZT-T (JAN 1999 ON)

CATALYTIC CONVERTERS

1.8 Petrol - exc: 1.8 Turbo

1.8 Turbo Petrol

2.0 Diesel

2.0/2.5 Petrol V6 - exc: MG ZT/ZT-T

MG ZT/ZT-T, 2.5 Petrol V6

WCGJ000521SLP

WAG000662SLP

WCGJ101001SLP

WCGJ000391SLP

WCGD001070SLP

DOWNPIPE

1.8 Turbo Petrol

For all other models Downpipes and Catalytic Converters are complete.

WCGD001650SLP

INTERMEDIATES

1.8 Petrol -exc: 1.8 Turbo

1.8 Turbo Petrol

2.0/2.5 Petrol V6 - exc: MG ZT/ZT-T

MG ZT/ZT-T, 2.5 Petrol V6

WCE104330SLP

WCE000530

WCE104350SLP

WCE000530

MANIFOLD TO CONVERTER 2.0 Diesel

WGD000220

REAR ASSEMBLIES

Saloon, 1.8 Petrol -

exc: 1.8 Turbo / MG ZT

Tourer, 1.8 Petrol -

exc: 1.8 Turbo / MG ZT-T

Saloon, 1.8 Turbo Petrol - exc: MG ZT

Saloon, 2.0/2.5 Petrol - exc: MG ZT

Saloon 2.0 Diesel

Tourer, 2.0 Diesel

MG ZT Saloon, 1.8 Turbo Petrol

MG ZT-T Tourer, 1.8 Turbo Petrol

MG ZT Saloon, 2.0 Diesel

MG ZT-T Tourer, 2.0 Diesel

MG ZT Saloon, 2.5 Petrol, 160PS

MG ZT Saloon, 2.5 Petrol, 190PS

MG ZT-T Tourer, 2.5 Petrol, 160PS

MG ZT-T Tourer, 2.5 Petrol, 190PS

WCG102840SLP

WCG000270SLP

WDE000550

WCG102850SLP

WCG102831SLP

WCG000291SLP

WCG000301

WCG000311

WCG000530

WCG000540

WCG000340

WCG000350

WCG000301

WCG000311

Originally Rover 75/MGZT exhausts were in one piece therefore a sleeve and clamps may be required when fitting replacement sections.

SLEEVE AND CLAMP for Joining Exhaust Sections

1800 Petrol models (4 required)

1800 Petrol Turbo models (2 required)

2000/2500 Petrol V6 models

Down Pipe to Intermediate section

Intermediate to Rear section

2000 Diesel models (2 required)

FS108257MA

WYE100360

WYE100360

WYE100350

FS108257MA

REAR EXHAUST MOUNTING A II Models

Lower

Upper

WCU000311

WCU101021



LIGHTING

ROVER 75 / ZT / ZT-T (JAN 1999 ON)

HEADLAMPS, RHD VEHICLES

All models, RH, up to 4D297145

All models, LH, up to 4D297145

Black Bezel,

RH, from 4D297146 up to 4D321637

LH, from 4D297146 up to 4D321637

Headlamps, xenon, all models,

RH, up to 4D321637

LH, up to 4D321637

RH, from 4D321638

LH, from 4D321638

Headlamp Projector,

RH, from 3D261240 up to 4D321637

LH, from 3D261240 up to 4D321637

RH, from 4D321638 - exc: MG ZT

LH, from 4D321638 - exc: MG ZT

MG ZT/ZT-T, headlamp projector,

RH, from 4D321638

LH, from 4D321638

XBC002540

XBC002550

XBC002630

XBC002640

XBC104000

XBC104010

XBC002800

XBC002810

XBC002160

XBC002170

XBC002760

XBC002770

XBC002780

XBC002790

HEADLAMPS, LHD VEHICLES

All models, RH, up to 4D297145

All models, LH, up to 4D297145

Black Bezel,

RH, from 4D297146 to 4D321637

LH, from 4D297146 to 4D321637

Headlamps, xenon, all models,

RH, up to 4D321637

LH, up to 4D321637

Headlamps, xenon, all models,

RH, from 4D321638

LH, from 4D321638

Headlamp projector,

RH, from 3D261240 up to 4D321637

LH, from 3D261240 up to 4D321637

RH, from 4D321638 - exc: MG ZT

LH, from 4D321638 - exc: MG ZT

MG ZT/ZT-T, headlamp projector,

RH, from 4D321638

XBC002560

XBC002570

XBC002650

XBC002660

XBC103980

XBC103990

XBC002860

XBC002870

XBC002180

XBC002190

XBC002820

XBC002830

XBC002840

INDICATOR LAMPS

All models, RH, up to 4D321637 - exc: MG ZT

All models, RH, from 4D321638 - exc: MG ZT

All models, LH, up to 4D321637 - exc: MG ZT

All models, LH, from 4D321638 - exc: MG ZT

MG ZT/ZT-T, all models, up to 4D321637

MG ZT/ZT-T, all models, from 4D321638

XBD000100

XBD000140

XBD000110

XBD000150

XBD000010

XBD000180

REAR LAMPS

Saloon, RH - exc: MG ZT

Saloon, LH - exc: MG ZT

Tourer, RH - exc: MG ZT-T

Tourer, LH - exc: MG ZT-T

MG ZT Saloon, RH

MG ZT Saloon, LH

MG ZT-T Tourer, RH

MG ZT-T Tourer, LH

XFB101300

XFB101310

XFB101660

XFB101670

XFB000500

XFB000510

XFB000520

XFB000530

HEADLAMP BULBS

Dip beam, H7, all models

Dip beam, H7, blue vision, from 3D261240

Xenon burner, headlamp

H1-55 Watt, Halogen,

standard, main beam, up to 4D321637



ROVER 75 / ZT / ZT-T (JAN 1999 ON)

PRICES
SEE PAGES 124-151
OR VISIT OUR
WEBSITE



COLLISION PARTS - FRONT

ROVER 75 / ZT / ZT-T (JAN 1999 ON)

BONNET All models	BKA500130
BUMPERS	
All models,	
up to 4D321637 - exc: MG ZT/ZT-T	DPC000061LML
from 4D321638 - exc: MG ZT/ZT-T	DPB003040LML
MG ZT/ZT-T,	
all models, up to 4D321637	DPC000270LML
all models, from 4D321638	DPB003000LML
Premium	DPC001280LML
FRONT PANEL	
Petrol, all models - exc: 1.8 Turbo	ACA500021
Petrol, 1.8 Turbo	ACA500021
Diesel, all models	ACA500031
FRONT WING All models,	
RH	ASB500020
LH	ASB500030
GRILLE All models,	
up to 3D278136	
(use with catch FPC000050)	DHB102542MCJ
from 3D278137 up to 4D321637	DHB102542MCJ
from 4D321638	DHB000390MMM
LOWER GRILLE	
All Models, up to 4D321637 - exc. MG	DQY100250

COLLISION PARTS - REAR

ROVER 75 / ZT / ZT-T (JAN 1999 ON)

REAR BUMPER	
Saloon, up to 4D321637	DQC000041LML
Saloon, from 4D321638	DQC001010LML
Tourer,	
up to 4D321637 - exc: parking aid	DQC101531LML
from 4D321638 - exc: parking aid	DQC001030LML
REAR PANEL	
Saloon	AQA500010
Tourer	AQA500030
BACKLIGHT ASSEMBLY GLASS Tourer	QQB000520

PROTECTION & STOWAGE

ROVER 75 / ZT / ZT-T (JAN 1999 ON)

ANTI SLIP BOOT LINER Saloon	VUB112420
PLASTIC BOOT LINER Tourer	EBF000010
RUBBER BOOT LINER Tourer	EBF000020
REAR SUN BLIND Saloon	EPU100190
HEADLAMP PROTECTOR KIT	
All models to 4D321637	XBV100600
All models from 4D321638	XBV100601
MUD GUARDS Black	
Front Pair All Models	
(exc. Where side sills are fitted)	CAS100730PMA
Rear Pair	
Saloon to August 2004	CAT100860PMA
Tourer to August 2004	CAT101310PMA
MG LOGO RUBBER MATS	
Front MG models	
RHD	EAH000230PMA
Rear MG models	EAH000520PMA
ROVER LOGO RUBBER MATS	
Front Rover models	
RHD	EAH104070PMA
LHD	EAH104120PMA
Rear Rover models	EAH104410PMA
MG LOGO FABRIC MAT SET , ash grey	
MG models, RHD	EAH000180LNF
MG models, LHD	EAH000190LNF

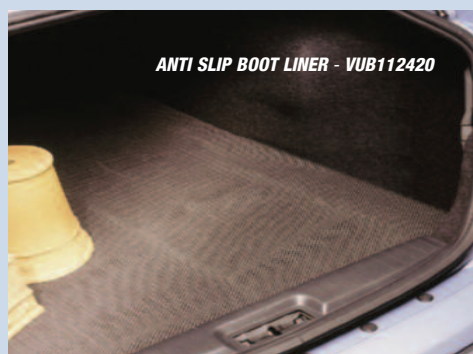

ANTI SLIP BOOT LINER - VUB112420

STYLING

ROVER 75 / ZT / ZT-T (JAN 1999 ON)

CHROME DOOR MIRROR COVERS	
Bullet Shaped (pair)	
All models to 2D255986	CRC100190MMM
Domed (pair)	
All models from 2D255987	CRC100960MMM
SPORTS SIDES SILL COVER Full Length, primed	
Will not fit with front Mud Guards	
All models RH	DDJ000400LML
All models LH	DDJ000410LML
SPORTS REAR BUMPER SPOILER KIT	
All models	VUB002690LML
COMPETITION PEDAL SET All models	RP1095
MG TAX DISC HOLDER (available in silver or black)	
MG models	RP1097
MG LOGO 'TOURING' GEAR KNOB	
MG models	RP1100
ANTI THEFT AERIAL (various colours available)	
All models	RP1096

TOURING

ROVER 75 / ZT / ZT-T (JAN 1999 ON)

TOWING MIRROR All models	CRB108270
CYCLE CARRIER for use with towbar with	
13 pin electrics All models	VUB111910
12N electrics All models	VUB111900
ROOF CROSS BARS Tourer	CAB105580ALT
SKI CLIPS (pair) for use with Roof Bars	CAN100140
SKI ACCESSORY BAG All models	VUP100090
ROOF RAIL (Runs along the length of the roof)	
RH Tourer All models	CAC000020PMA
LH Tourer All models	CAC000030PMA
BRACKETS (6 required) Tourer All models	CAX100170
BOLT (6 required) Tourer All models	FT106257MA
BOLT (12 required) Tourer All models	CYG100410
TRAFFICMASTER ECU	XVS000030
TRAFFICMASTER CONNECTORS (3 req)	YPC116330
ESSENTIALS XTRA KIT	XPT000138ACA
INTERIOR CARE XTRA KIT	XPT000139ACA
ESSENTIALS & INTERIOR CARE KIT	RP1017
Includes XPT000138ACA & XPT000139ACA	
POWER SOURCE INVERTER - converts 12V DC into 240V AC	
150 watt model	RX1551-150
300 watt model	RX1551-300
500 watt model	RX1551-500
TRAILER / REAR LIGHTING BOARD	
4ft Inc cable	RX1513

SAFETY

ROVER 75 / ZT / ZT-T (JAN 1999 ON)

FIRE EXTINGUISHER	
600gm Red Alloy	S3SSFE1
Red, Powder, 1Kg	GAC9904X
PARKING AID UNIVERSAL KIT All models	RX1559
including 4 sensors and all fittings.	
HEATED WASHER JET CONVERSION KIT	VUB102110
WARNING TRIANGLE Universal	RX1344
SAFETY VEST (luminous)	GAC2999

LITERATURE & MISC

ROVER 75 / ZT / ZT-T (JAN 1999 ON)

OWNERS HANDBOOKS	
Rover models	
vin 100750 to vin 216157	RCL0306ENG
vin 216158 to vin 264830	VDC000180EN
vin 264831 to vin 270360	VDC000350EN
vin 270361 to vin 279843	VDC000420EN
vin 279844 to vin 321637	VDC000480EN
vin 321638 on	VDC000560EN
MG models	
vin 216158 to vin 264830	VDC000190EN
vin 264831 to vin 270360	VDC000340EN
vin 270361 to vin 279843	VDC000450EN
vin 279844 to vin 321637	VDC000490EN
vin 321637 on	VDC000570EN
WORKSHOP MANUAL All models	RP1012
HAYNES "MAN" MANUAL - 128 pages,	
Health Guide in style of Workshop Manual	RX1534
HAYNES MANUAL PLASTIC PROTECTOR	RX1569
CORGI 1/43 DIECAST MODEL	RP1022
Various types & colours available.	
WHEELS & FITTINGS	
ROVER 75 / ZT / ZT-T (JAN 1999 ON)	
MG BADGED VALVE CAPS MG models	RRF100060
MG BADGED ANTI THEFT VALVE CAPS	
MG models	RRF100060PAT
SET 4 ALLOY WHEEL CENTRES	
"Silver Sparkle" Rover Models "Cross Spoke"	
& "Meteor" Alloy Wheels	RRB100460
WHEEL CENTRES - Bolts - Locking Bolts, Car Set	
Rover Models "Crown", "Contour"	
& "Union" Alloy Wheels	RRB100530MNH
WHEEL CLEANING BRUSH (Fir Tree Shape)	KACB101
MWS WHEEL CLEANING KIT	RX1405
AUTOGLYM CLEAN WHEELS Alloy Wheel Cleaner	
500ml	RX1322
AUTOGLYM ALLOY WHEEL SEAL 450ml	RX1443
RIMWAX Professional Wheel Polish and Sealer	RX1262
AUTOGLYM INSTANT TYRE DRESSING	RX1368
TYRE WELD Puncture Repair (Holts Brand)	
300ml	GAC9903X-300ML
400ml	GAC9903X-400ML
SNOW CHAINS pair for 7J x 17 wheels	
MG 17" wheel models only	VUJ000040
DIGITAL TYRE PRESSURE GAUGE	XPT000006ACA
TYRE TREAD DEPTH GAUGE	27298

NOTES



PRICES
SEE PAGES 124-151
OR VISIT OUR
WEBSITE

CITY ROVER (NOVEMBER 2003 ON)



SERVICE PARTS CITY ROVER (NOV 2003 ON)

AIR FILTERS All models	G279009130131
FUEL FILTERS All models	279109110102
OIL FILTERS All models	279018130103
SPARK PLUGS All models	279215189901
WIPER BLADES	
Blade-windscreen wiper - RH	282082409917
Blade-windscreen wiper - LH	282082409918
Blade-backlight wiper	270282409939
FUEL PUMPS All models	279115200123
TIMING BELTS All models	279105116303
ALTERNATOR BELTS	
5PK - 1075279123116302	279023126306
4 Grooves - 730	

BRAKING CITY ROVER (NOV 2003 ON)

BRAKE DISC , front each All models	277942103704
BRAKE PADS , front (1 Set) All models	277942100134
BRAKE SHOES , rear (1 Set) All models	284242300108
BRAKE WHEEL CYLINDERS All models,	
RH	277942300126
LH	277942300125
HANDBRAKE CABLES All models	284242700103

CLUTCH CITY ROVER (NOV 2003 ON)

CLUTCH COVERS All models	270225400103
CLUTCH PLATES All models	270225200119
CLUTCH RELEASE BEARINGS	
All Models	270225600105
CLUTCH KIT (cover,plate,bearing) All models	RP1127

COOLING CITY ROVER (NOV 2003 ON)

RADIATORS All models	279150100121
THERMOSTATS All models	279020120124
WATER PUMPS All models	G279020100108

ELECTRICAL CITY ROVER (NOV 2003 ON)

BATTERIES All models	ZUA000077E
-----------------------------	-------------------

EXHAUST SYSTEMS CITY ROVER (NOV 2003 ON)

DOWNPIPES All models	284249200101
CATALYTIC CONVERTERS All models	279149100125
RESONATOR All models	279149100128
REAR ASSEMBLIES All models	279149100138

LIGHTING CITY ROVER (NOV 2003 ON)

HEADLAMPS , RHD vehicles All models,	
RH	277954409932
LH	277954409933
INDICATOR LAMPS All models	284254409909
REAR LAMPS All models,	
RH	284254409919
LH	284254409915
HEADLAMP BULBS	
Main beam, h4-60/65 Watt	62120601011
Clear - Bulb-501, 5 Watt	62120601615
INDICATOR LAMP BULBS	
Amber - Bulb-381, 21 Watt	62120601712
REAR LAMP BULBS	
Bulb-380, 21/5 Watt62120601402	
Clear - Bulb-382, 21 Watt	62120601216
Amber, direction indicator - Bulb-381, 21 Watt	62120601712



STEERING & SUSPENSION CITY ROVER (NOV 2003 ON)

BALL JOINTS All models	G277532100138
TRAILING ARM ASSEMBLY , rear	
All Models, with bush -	
RH exc: anti-lock brakes	284232420133
LH exc: anti-lock brakes	284232420132
Anti-lock brakes,	
RH, semi-trailing, with bushes	284232420129
LH, semi-trailing, with bushes	284232420128
RH semi-trailing	270232430146
LH semi-trailing	270232430145
All Models, semi-trailing -	
RH exc: anti-lock brakes	282032420113
LH exc: anti-lock brakes	282032420112
TRACK ROD ENDS All models	885546010001
SHOCK ABSORBERS	
front All models, RH	284232100121
front All models, LH	284232100122
rear Complete assembly, RH	284232400107
rear Complete assembly, LH	284232400106
STEERING RACK GAITERS	
Mechanical steering	
RH	270246607731
LH	270246607730
Power steering RH or LH	270246600164
Kit including Gaiter, strap & clip	
DRIVE SHAFT GAITER KIT	
inner All models	269026300154
outer All models - exc: anti-lock brakes	269026300155
outer All models, anti-lock brakes only	269026300156
WHEEL BEARING KIT , front All models	G273135603102
WHEEL BEARING ASSEMBLY , rear	
Ring	284232428201
Roller bearing, outer	G265433403107
Bearing, outer	269533403103
Castle nut	12102296026
Rear hub seal - exc: anti-lock brakes	270235607805
Rear hub seal, anti-lock brakes only	270235608304
Shim, 0.1" thick	270235608305
Shim, 0.05" thick	270235608306
Shim, 0.04" thick	270235608308
Shim, 0.03" thick	270235608309
Shim, 0.025" thick	270235608310
Shim, 0.02" thick	270235608311
Shim, 0.015" thick	270235608312
Shim, 0.01" thick	270235108202
Spacer between rear hub bearings	13150609326
Split pin	270235609205
Thrust washer	

COLLISION PARTS CITY ROVER (NOV 2003 ON)

BONNET All models	26788870210220
BUMPER All models	284488506301
FRONT PANEL ASSEMBLY	
Front Panel	26786220210120
Reinforcement, bonnet striker	267862202121
Cross member, lower	26786220214720
FRONT WING All models,	
RH	28288810210120
LH	28288810210220
GRILLE All models	DHB000360LES
REAR BUMPER All models	284488606301

PROTECTION & STOWAGE CITY ROVER (NOV 2003 ON)

MUD GUARDS	
Front Pair All models	XPT000075ACA
exc. where side sills are fitted.	
Rear Pair All models	XPT000065ACA
OVERMAT SET - Front & Rear - Graphite All models	
RHD	XPT000068ACA
LHD	XPT000068ACB

TOURING CITY ROVER (NOV 2003 ON)

ESSENTIALS XTRA KIT	XPT000138ACA
INTERIOR CARE XTRA KIT	XPT000139ACA
ESSENTIALS & INTERIOR CARE KIT	RP1017
Includes XPT000138ACA & XPT000139ACA.	
POWER SOURCE INVERTER converts 12V DC into 240V AC	
150 watt model	RX1551-150
300 watt model	RX1551-300
500 watt model	RX1551-500

SAFETY CITY ROVER (NOV 2003 ON)

FIRE EXTINGUISHER	
600gm Red Alloy	S3SSFE1
Red, Powder, 1Kg	GAC9904X
PARKING AID UNIVERSAL KIT All models	RX1559
including 4 sensors and all fittings.	
WARNING TRIANGLE	
Universal	RX1344
Pair (in MG/Rover Badged Holder)	SAC880662
SAFETY VEST (luminous) All models	GAC2999

LITERATURE CITY ROVER (NOV 2003 ON)

OWNERS HANDBOOKS	VDC000530EN
HAYNES "MAN" MANUAL	RX1534
128 pages, Health Guide in style of Workshop Manual	
HAYNES MANUAL PLASTIC PROTECTOR	RX1569

WHEELS & FITTINGS CITY ROVER (NOV 2003 ON)

WHEEL CLEANING BRUSH (Fir Tree Shape)	KACB101
MWS WHEEL CLEANING KIT	RX1405
AUTOGLYM CLEAN WHEELS Alloy Wheel Cleaner	
500ml	RX1322
AUTOGLYM ALLOY WHEEL SEAL 450ml	RX1443
AUTOGLYM INSTANT TYRE DRESSING	RX1368
RIMWAX Professional Wheel Polish and Sealer	RX1262
TYRE WELD Puncture Repair (Holts Brand)	
300ml	GAC9903X-300ML
400ml	GAC9903X-400ML
DIGITAL TYRE PRESSURE GAUGE	XPT000006ACA
TYRE TREAD DEPTH GAUGE	27298

NOTES



ROVER Mini (1958 TO 2000)

PRICES
SEE PAGES 124-151
OR VISIT OUR
WEBSITE



SERVICE PARTS

ROVER MINI (1959 TO 2000)

AIR FILTERS

848 and 998CC
1300 Single Carb
1300 Spi and Mpi

12G806EVA
12G3699EVA
PHE10015EVA

FUEL FILTERS

Spi and Mpi to WD169573
Spi and Mpi from WD169574

WJN101520EVA
WJN101191

OIL FILTERS

Vehicles with Manual Gearbox
Paper Element Type (early models)
Spin On Canister Type up to BD134454
Spin On Canister Type from BD134455
Vehicles with Automatic Gearbox
Paper Element Type

LPZ000130EVA
12G2400SLP
LPW100181

GFE104

LUMENITION ELECTRONIC IGNITION KIT

Early Lucas 25D Distributors
Lucas 45D and 59D Distributors
(Points Distributors)
45DE4 (Electronic Distributors)
Ducellier Distributors

RR1113
RL1262
RP1133
LL1316

DISTRIBUTOR CAPS

Early Lucas 25D Distributors
(Side Entry Type)
Lucas 45D and 59D Distributors
(Top Entry Type)
Ducellier Distributors
All 1300 Models from 1990-1997

NJD000110EVA
NJD000143EVA
ADU8532EVA
ADU8814EVA

ROTOR ARMS

Early Lucas 25D Distributors
Lucas 45D and 59D Distributors
Ducellier Distributors
All 1300 Models from 1985

246005EVA
59321324EVA
NJE002123EVA
RTC3990EVA

CONTACT SET

Early Lucas 25D Distributors
Lucas 45D Distributors
Lucas 59D Distributors
Ducellier Distributors

37H4414EVA
RTC364EVA
EDP109EVA
NJL000119EVA

CONDENSER

Early Lucas 25D Distributors
Lucas 45D and 59D Distributors
Ducellier Distributors

RTC002111EVA
RTC0365EVA
RTC3526EVA

COIL

Up To Approx. 1982 (Non Ballasted)
From Approx. 1982 to 1990 (Ballasted)
From 1990 To 1997 (Electronic Ignition)

13H8213EVA
ADU8116EVA
ADU6717EVA

LUMENITION MEGA SPARK

Recommended for use with Lumenition Electronic Ignition Kits

GCL132MS

COIL PACK From 1997 (Mpi)

NEC100710

HT LEAD SET

1968 To 1997 (Top Entry Type)
From 1997 (Mpi)

NGC10011EVA
NGC103060EVA

SPARK PLUGS

To 1986
1986 To 1990
From 1990

GSP4362
GSP4382
NLP100260EVA

WIPER BLADES

(Up To 1990) Silver
(Up To 1990) Black
(From 1990) All Models

GWB219
DKC000029SLP
DKC000029SLP

FUEL PUMPS

Carb except Cooper - Up To VIN 504653
Carb except Cooper - From VIN 504654
Carb Cooper
Spi
Mpi

AZX1818
WND10005
AZX1817
WFX10045
WFX100810

ALTERNATOR BELTS

All models to 1981
All models 1981-1985
All models 1985 to 1996 (BD134454)
All models from BD134455

GCB10813
ADU4237EVA
12H3165EVA
PQS050925EVA

ENGINE

ROVER MINI (1959 TO 2000)

CYLINDER HEAD STUD All Models

Long
Short

CAM150P
CAM151

OIL PUMP ASSEMBLY

998CC Pre A +
998CC A +
1300 A+

GLP142
GLP139
GLP138

ENGINE MOUNTINGS

ROVER MINI (1959 TO 2000)

BUSH - ENGINE MOUNT

Manual Transmission Models
Automatic Transmission Models - RH
Automatic Transmission Models - LH

21A1902SLP
22A917
22A1018

BUSH - ENGINE STABILISER BAR

All Models

KKF100390

POLYURETHANE BUSH - Engine Stabiliser Bar

All Models

KKF100390POLY

ENGINE CONTROLS

ROVER MINI (1959 TO 2000)

ACCELERATOR CABLE

Carb Models Up To 1990 RHD & LHD
Carb Models From 1990 - RHD
Carb Models From 1990 - LHD
Spi - LHD To BD60473
Spi - LHD From BD60473
Mpi - RHD
Mpi - LHD

NAM7914
SBB10099
SBB10126
SBB10186
SBB102500
SBB103400
SBB103720

CHOKE CABLE

MK1/2 (To 1969)
From 1969 To VIN278182
From VIN 278183 To 1990
From 1990 (1300 Carb Models)

21A1202P
21A2329
SBF10027
SBF10031

BRAKING

ROVER MINI (1959 TO 2000)

FRONT BRAKES

Vehicles Fitted With Disc Brakes
Brake Disc Each - 7" Disc 10" Wheel
Brake Disc Each - 7.5" Disc 10" Wheel
Brake Disc Each - 8.4" Disc 12" Wheel
Brake Pad Set - 7" Disc 10" Wheel
Brake Pad Set - 7.5" Disc 10" Wheel
Brake Pad Set - 8.4" Disc 12" Wheel
Upated Brake Pad Set - Greenstuff Kevlar
8.4" Disc 12" Wheel

BTA193P
SDB000101EVA
21A2612SLP
18G8336SLP
18G8535EVA
CDU3030EVA
CDU3030GS

Vehicles Fitted With Drum Brakes

Brake Shoe Set - All Models
Wheel Cylinder RH - 1964-1967 MK1
(Twin Leading Shoe Type)
Wheel Cylinder LH - 1964-1967 MK1
(Twin Leading Shoe Type)
Wheel Cylinder RH - 1967 - 1984 MK2
Wheel Cylinder LH - 1967 - 1984 MK2

8G8814EVA
SML000102EVA
SML000103EVA
37H2015EVA
SML000127EVA

REAR BRAKES

Brake Shoe Set - All Models
Wheel Cylinder Each All models

SFS10003EVA
17H8152EVA

REMOTE MOUNTED SERVO KIT

All models With Single Line Brake Hydraulics

RH5272

HANDBRAKE CABLES

Twin Cable System Dry Suspension
Up To 1976 (Twin Cable System)
Twin Cable System Hydroelastic Suspension
Up To 1976 (Twin Cable System)
From 1976 - front (Lever to compensator)
From 1976 - rear (Between the rear wheels)

GVC2022
GVC1021P
FAM6240EVA
FAM2903EVA

CLUTCH

ROVER MINI (1959 TO 2000)

CLUTCH KITS

Diaphragm Clutch Up To Approx. 1982
Verto Clutch From Approx. 1982 - 1985
(Vehicles Fitted With Inertia Starter)
Verto Clutch From 1985 - 1990 (Vehicles Fitted
With Pre-Engaged Starter)
From 1991 - Carb
From 1991 -
Spi inc flywheel to BD134454
From BD134455 - Mpi inc flywheel

URF008855EVA
URF008652EVA
URD090115EVA
URF006604EVA
URD10011EVA
URD100210EVA

CLUTCH PLATES Not available separately see clutch kits.

CLUTCH RELEASE BEARINGS

Not available separately see clutch kits

COOLING & HEATING

ROVER MINI (1959 TO 2000)

RADIATORS

All Models Up To 1990 - Side mounted
From 1990 To BD134454 - Side mounted
From BD134455 - Front Mounted

ARP2000EVA
PCC103980SLP
PCC106340SLP

THERMOSTATS

74 C - Hot Climates/Summer
82 C - Standard Up To 1985
88 C - Standard From 1985

13H6284EVA
13H4070EVA
13H7604

THERMOSTAT GASKETS All Models

12G330EVA

WATER PUMPS

All Models up To 1990 (With Bypass Outlet)
From 1990 To BD134454
(Carb & Spi - No Bypass Outlet)
From BD134455 (Mpi - No Bypass Outlet)

CAM4255SLP
PEB10036SLP
PEB10037SLP

TOP HOSE

848CC, 998CC & 1098CC up to 1967
848CC, 998CC & 1098CC from 1967
Cooper & Cooper S
1275GT
From 1991 - 1300 Carb
From 1991 - 1300 Spi
(VIN BD31530 To BD134454)
(From VIN BD134455)
From 1996 - 1300 Mpi
(Front mounted Radiator)

PCH000244EVA
12G1163EVA
GRH247P
GRH469P
PCH10566EVA
PCH10566EVA
PCH113500EVA
PCH113560EVA

BOTTOM HOSE

848CC, 998CC & 1098CC (Not Clubman)
998CC, 1098CC & 1300 (Clubman)
From 1991 - 1300 Carb
From 1991 - 1300 Spi
From 1996 - 1300 Mpi
(Front mounted Radiator)

12A1550EVA
GRH468P
PCH10476EVA
PCH10735EVA
PCH113480EVA

WATER PUMP BYPASS HOSE Up To 1992

12A2178EVA

HEATER VALVE

To VIN 396448 (Fitted on Cylinder Head)
From VIN 396449 To BD134454
(Remote mounted in Engine Bay)
From BD134455 (Remote mounted in Interior)

ADU9102
JJB10011
JJB100260

HEATER WATER OUTLET on Cylinder Head

For Use With Remote Mounted Heater Valves
From VIN 396449

12G2534

GASKET For Heater Valve/Water Outlet - All models

88G221

HEATER CABLE

MK1 Up To Approx. 1964
1964 To 1989 (VIN 396448)
998 CC VIN 396449 To VIN 463230
998 CC From VIN 463231
1300 CC 1990 To BD134454
1300 CC From BD134455

14A9988P
24A2738P
JFF10003
JFF10048P
JFF10051P
JFF100910





PRICES
SEE PAGES 124-151
OR VISIT OUR
WEBSITE

ROVER Mini (1958 TO 2000)



ELECTRICAL & INSTRUMENTS ROVER MINI (1959 TO 2000)

BATTERIES All models	ZUA000038E
STARTER MOTOR	
Inertia Up To 1985	13H5799E
Pre-Engaged From 1985	ADU9800E
STARTER SOLENOID	
Vehicles Fitted With Inertia Starter	NAF000010
DYNAMO 1964 To 1972	GXE3101
ALTERNATOR	
Up To 1981	589715E
1981 To 1985	BAU2225E
Mpi	YLE101790EP
WIPER MOTOR All Models	216148E
OIL PRESSURE SWITCH All Models	88G563EVA
TEMPERATURE TRANSMITTER	
All Models	YCB000101EVA
SPEEDO CABLE	
Vehicles with Centre Binnacle Instruments	
Mk1/2 RHD	YBD000101EVA
Mk1/2 LHD	GSD152P
Lucas Instruments	
From 1980 RHD To VIN 122248	GSD102P
From VIN 122249 RHD	YBD000415EVA
From 1980 LHD	ADU5919EVA
Nippon Seiki Instruments	
From 1980 RHD To BD395999	YBD000417EVA
From BD396000 RHD	YBD10101EVA
From 1980 LHD To BD395999	YBD000418EVA
From BD396000 LHD	YBD10075EVA

BRAKE LIGHT SWITCH	
Mechanical Type	134529
Hydraulic Type	XKB100090
REVERSE LIGHT SWITCH All Models	GAE191A
FLASHER UNIT All Models	13H4393EVA
HAZARD WARNING RELAY All Models	154577EVA
TRANSMITTER BATTERIES	
All models to BD103112	YWK10004
All models from BD103113	YWK10003 PAIR
TRANSMITTER	
All models from BD58745 to BD103112	YWX000320
All models from BD103113	YWX101220A

EXHAUST SYSTEM ROVER MINI (1959 TO 2000)

FULL SYSTEM (1 Piece System)	
Single Box System (Up To Approx. 1974)	WCD000106EVA
Twin Box System - (Approx. '74 To '92)	WCD000177EVA
FRONT PIPE Repairs Front Section of Single Box 1 Piece Systems	GEX1285
REAR BOX Repairs Rear Section of Single Box 1 Piece Systems	GEX3674
DOWNPIPES	
Twin Carb with catalytic converter	WCD10111EVA
Single Carb, open loop catalytic converter	
Manual	WCD10150EVA
Auto	WCD10149EVA
Injection	
Manual	WCD10195EVA
Automatic	WCD10194EVA
CATALYTIC CONVERTERS All models	WAG103910SLP
REAR ASSEMBLIES	
Carb with catalytic converter	WDE10002EVA
Carb with open loop catalytic converter	WCE10116EVA
Spi except Japan	WCE10172EVA
Mpi	WCE103370EVA
SPI Japan (Manual Up To BD59821, Auto Up To 59844)	WCE10181SLP
SPI Japan (Manual From BD59822, Auto From BD59845)	WCE102130EVA
Sports	WDE100330



LIGHTING ROVER MINI (1959 TO 2000)

HEADLAMP UNIT COMPLETE

RHD vehicles	
Up To 1990	BHM7199
All Saloon models except Clubman	BHM7196
Clubman	BHM7199
All models except Cooper (to BD134454)	XBC10197
Cooper models (to BD134454)	
From BD134455 to BD162978, except Japan (Levelling)	XBC103780
From BD162979 except Japan (Levelling)	XBC105220
Japan From BD134455 to BD162978	XBC103670
Japan From BD162979 (Levelling)	XBC105210
LHD vehicles	
From 1990 To BD134454 (Except Germany)	BAU1177A
From BD134455 to BD162978 (Levelling - Except Germany)	XBC104060
From BD162979 (Levelling - Except Germany)	XBC105230
From 1985 Germany - (Levelling)	XBC103220

HEADLAMP ONLY

Sealed Beam	
RHD - Up To 1990 All Saloon models except Clubman	13H3471A
RHD - Clubman	XBC103360
RHD - From 1990 All models (to BD134454)	13H3471A
Lens Unit	
RHD - From BD134455 (Levelling)	XBC104430
LHD - To BD134454 (Except Germany)	GLU515
LHD - From BD134455 (Levelling - Except Germany)	XBC103410
LHD - From 1985 Germany - (Levelling)	XBC103410

HALOGEN CONVERSION KIT (Includes 2 Lens Units & Bulbs)

RHD - Without Pilot Hole For Sidelight (Replaces XBC10103)	RB7129
RHD - With Pilot Hole For Sidelight (Replaces 13H3471A)	RB7129PILOT
LHD - With Pilot Hole For Sidelight (Replaces GLU515)	RB7082PILOT

5" DRIVING LAMPS All Models

Chrome	RX1556
Stainless Steel	RX1556SS
INDICATOR LAMPS	
All models to BD134454 rim retained lens (orange)	121356
screw retained lens (orange)	AFU3389
All models from BD134454 screw retained lens (clear)	XBD100670

SIDE REPEATER LAMPS

All models (orange)	AHU2592
All models optional (clear)	XGB000060A
CLEAR SIDE REPEATER LAMP CONVERSION KIT Includes 2 Clear Side repeater lamps & 2 Amber Bulbs	
All Models	RP1042

REAR LAMPS

RH MK1 (With Amber Flasher Lens)	13H223P
LH MK1 (With Amber Flasher Lens)	13H222P
RH MK2/3 (Without Reverse Lamp)	13H6479P
LH MK2/3 (Without Reverse Lamp)	13H6480P
RH MK4 on (With reverse lamp)	XFB101900
LH MK4 on (With reverse lamp)	XFB101910

REAR FOG LAMPS

RH all models	XFE10006
LH all models except Japan	XFE10007

HIGH MOUNTED STOP LAMP

All models From YD187532	XFN100160
--------------------------	-----------

HEADLAMP BULBS

RHD All Models To BD134454 - Sealed Beam	(See Headlamp Section)
RHD All models from BD134455	XZQ000150
LHD To BD134454 (Except Germany - France)	GLB410
LHD All models from BD134455 (Except Germany - France)	XZQ000150
LHD To 1985 (Germany)	GLB410
LHD From 1985 (Germany)	XZQ000150
LHD To BD134454 (France)	GLB411
LHD From BD134455 (France)	GLB476

SIDE LAMP BULBS

RHD To BD134454 (Except Clubman)	AFU4481
RHD Clubman	GLB989
RHD From BD134455	GLB233
LHD All Models	GLB233

INDICATOR LAMP BULBS

Clear - Bulb-382, p25/1-21 Watt to BD134454	GLB382
Amber - bulb-344, 21 Watt, from BD134455	XZQ100190L
Capless, side repeater, bulb-501, Clear, w10/5-5 Watt	AFU4481
Amber, w10/5 Watt, optional	XZQ100210L

REAR LAMP BULBS

Stop/tail - Bulb-380, 21/5 Watt	GLB380
Clear (flasher/reverse/fog rearward) - Bulb-382, p25/1-21 Watt	GLB382

STEERING & SUSPENSION - FRONT ROVER MINI (1959 TO 2000)

BALL JOINT KIT front upper and lower

All models	8G4197EVA
------------	-----------

UPPER ARM FULCRUM SHAFT All models

	2A4325
--	--------

UPPER ARM FULCRUM SHAFT REPAIR KIT

All Models	2A4325KP
------------	----------

KNUCKLE JOINT - FRONT All Models

	RBK10007EVA
--	-------------

TRACK ROD ENDS All models

	QJB10004EVA
--	-------------

CONE SPRING All Models

	FAM3968
--	---------

SHOCK ABSORBERS - FRONT

All models except Sports Suspension	RBB071541EVA
Gaz Adjustable All Models	
Standard Ride Height	RBB071541EVA GAZ
Lowered Ride Height	RBB071541EVA GAZ LOW
Spax Adjustable All Models	
Standard Ride Height	RBB071541EVA SPAX
Lowered Ride Height	RBB071541EVA SPAX LO

STEERING & SUSPENSION - REAR ROVER MINI (1959 TO 2000)

RADIUS ARM KIT - REAR All Models

	8G7134EVA
--	-----------

KNUCKLE JOINT - REAR All Models

	21A1163EVA
--	------------

CONE SPRING All Models

	FAM3968
--	---------

SHOCK ABSORBERS - REAR

All models except Sports Suspension	RPD071542EVA
Gaz Adjustable All models	
Standard Ride Height	RPD071542EVA GAZ
Lowered Ride Height	RPD071542EVA GAZ LOW
Spax Adjustable All models	
Standard Ride Height	RPD071542EVA SPAX
Lowered Ride Height	RPD071542EVA SPAX LO



ROVER Mini (1958 TO 2000)

PRICES
SEE PAGES 124-151
OR VISIT OUR
WEBSITE



STEERING & SUSPENSION -

DRIVE LINE

ROVER MINI (1959 TO 2000)

DRIVE SHAFT GAITER KIT All models

Inner **BHM7012EVA**
Outer **BAU2019EVA**

DIFFERENTIAL SEALS All models

ADU5738

WHEEL BEARING KIT

Front Drum Brake **AAU8806EVA**
Front Disc Brake **21A1400SLP**
Rear All models **RFM001805EVA**

HUB NUT - Front - Slotted

1 1/8" AF Drum Brake **21A79**
1 5/16" AF Disc Brake **BTA249**

WHEEL STUD

Front Drum Brake **21A2064X**
Front Disc Brake **NAM5645**
Rear To Approx. 1984 (10" wheels) **21A2064X**
Rear From Approx. 1984 (12" Wheels) **RLJ10001**

WHEEL NUTS

Standard 10" Steel Wheels **88G322**
Standard 12" Steel Wheels **113087**

SUBFRAME & FITTINGS

ROVER MINI (1959 TO 2000)

SUBFRAME (Rubber Mounted To Chassis)

Manual Transmission **KGB10027**
From 1976 to BD134454 **KGB100500**
From BD134455

MOUNTING All models

Front **21A2624SLP**
Rear **21A2599**

COLLISION PARTS - FRONT

ROVER MINI (1959 TO 2000)

BONNET

Saloons From 1970 to BD134454 (Exc. Clubman*) **BKA360110**
From BD134455 (Mpi) **BKA360070**

BUMPER FRONT AND REAR

All models except Germany (Saloons Exc. Clubman*)
Black **DPB10085PMG**
Chrome **DPB10166SLPP**
Stainless Steel **DPB10166SLP**

FRONT PANEL

From 1976 To BD134454 (Exc. Clubman*) **ASJ36002**
From BD134455 (Exc. Clubman*) **ASJ360070**

*NOTE: For Clubman parts - please enquire.

FRONT WING

From 1970 To 1985 (No Hole For Side Repeater)
RH **14A6476**
LH **14A6477**

From 1985 (With Hole For Side Repeater)
RH **BMP454**
LH **BMP455**

requires modification for Sportspac

"A" PANEL

RH From 1970 **ALA5660**
LH From 1970 **ALA5661**

GRILLE

Up To BD58253 (Bright - 11 Slats - External Bonnet Release) **DHB10150MMM**

From BD58254 (Bright - 11 Slats - Internal Bonnet Release) **DHB102140MMM**

Cooper Up To BD58253 (Bright - 8 Slats - External Bonnet Release) **DHB10151MMM**

Cooper From BD58254 (Bright - 8 Slats - Internal Bonnet Release) **DHB102150MMM**

MOULDING Stainless Steel Upper

ALA6559MMM

COLLISION PARTS - SIDE

ROVER MINI (1959 TO 2000)

INNER SILL All Models

RH **BHM13RHP**
LH **BHM13LHP**

COLLISION PARTS - REAR

ROVER MINI (1959 TO 2000)

REAR PANEL

Upper - For Square Type Rear Lamps **ALA6417**
Lower - Models With Rear Fog Lamp Fitted **CZH3353**

BOOT LID

From 1970 To VIN398599 **BMP339**
From VIN 398600 **BMD36001**

PROTECTION & STOWAGE

ROVER MINI (1959 TO 2000)

SPOTLAMP COVERS, pair,

All models with OE front spot or fog lamps
Cooper branded **XBV100300**
Mini branded **XBV100610**

PLASTIC BOOT LINER All models

EBF100150

REAR MUDFLAPS, pair,

Cooper Branded All models **CAT10044**
Mini Branded All models **CAT100870**

OUTDOOR "MONSOON" SEMI-TAILORED CAR COVER

All Saloon Models **RP1147**

STYLING

ROVER MINI (1959 TO 2000)

PLASTIC WHEEL ARCH EXTENSION KIT (Set Of 4)

All Models **AJM1117P**

WHEEL ARCH EXTENSION KIT - Sportspac Type

Modification to Wing Arch Profile may be required
All models **DFT100820MLM**

POLISHED STAINLESS STEEL DOOR MIRROR

LH All models **CRB108350**
RH All models **CRB108340**

CHROME BULLET DOOR MIRROR All models

GAM105

BONNET BADGE

MINI Silver On Black To VIN349159 **CZH4378**
MINI COOPER WINGED

From 1992 **DAB10079**
From 1992 **DAH10036**

WINGED MINI Green/Chrome

All models from BD134455 (1997) **DAH100580MMM**

BOOT BADGE - WINGED MINI Green/Chrome

All models from BD134455(1997) **DAH100590MMM**

TYRE VALVE CAP SET Mini Cooper

RRF100040

ROCKER COVER All models

Black **LDR10074**
Alloy **LDR10074 ALLOY**
Alloy - Ribbed **LDR10074 ALLOY R**
Alloy - Slanted & Ribbed **LDR10074 ALLOY SR**

POLISHED WIPER ARM & BLADE KIT

RHD All models **WPA9022X**
EED10065

GLASS SUNROOF KIT All models

XPT000005ACA
XPT002100AC

STEBEL AIR HORN All models

Red **XPT000005ACA**
Black **XPT002100AC**

AUDIO/NAVIGATION

ROVER MINI (1959 TO 2000)

AERIAL front wing All models to BD134454

AJM1112

REAR SPEAKER ASSEMBLY, Black Paul Smith, 40th

Anniversary & John Cooper LE models **XQM101360PMA**

TOURING

ROVER MINI (1959 TO 2000)

ESSENTIALS XTRA KIT All models

XPT000138ACA

INTERIOR CARE XTRA KIT All models

XPT000139ACA

ESSENTIALS & INTERIOR CARE KIT

Includes XPT000138ACA & XPT000139ACA
All models **RP1017**

POWER SOURCE INVERTER - converts 12V DC into 240V AC

150 watt model **RX1551-150**
300 watt model **RX1551-300**
500 watt model **RX1551-500**



SAFETY

ROVER MINI (1959 TO 2000)

EXTERIOR TEMPERATURE WARNING KIT

All models **VUB100160**

FIRE EXTINGUISHER

600gm Red Alloy **S3SSFE1**
Red, Powder, 1Kg **GAC9904X**

WARNING TRIANGLE Universal

RX1344

SAFETY VEST (luminous) All Models

GAC2999

LITERATURE & MISC

ROVER MINI (1959 TO 2000)

OWNERS HANDBOOKS

1995/1996 Cabriolet Models **RCL0015ENG**

HAYNES WORKSHOP MANUAL

1959-1969 **RP1143**
1969 to 2001 models - exc ERA Turbo & Cabriolet **RP1041**

HAYNES "MAN" MANUAL - 128 pages,

Health Guide in style of Workshop Manual **RX1534**

HAYNES MANUAL PLASTIC PROTECTOR

RX1569

BRITISH MOTOR HERITAGE SPECIAL TUNING DATA DVD

MK2/3 850, 1000, 1275, Cooper & Cooper S **HMCC2006**

BRITISH MOTOR HERITAGE DVD

Includes Parts & Workshop Manuals & Owners Handbook.
1959-1969 **HMCC4001DVD**
1969-1985 **HMCC4002DVD**
1985-2000 **HMCC4003DVD**

PRICES
SEE PAGES 124-151
OR VISIT OUR
WEBSITE

NEW MINI



NEW MINI

SERVICE PARTS
NEW MINI

SERVICE KIT

- Includes Air, Oil, Cabin Filters & 4 Spark Plugs
MINI One (Petrol) & Cooper Up To 06/04 **RBMW1016**
MINI One (Petrol) & Cooper 07/04 To 11/06 **RBMW1017**
Cooper S Up To 11/06 **RBMW1019**
- Includes Air, Oil, Cabin & Fuel Filters
MINI One Diesel Up To 11/06 **RBMW1018**

AIR FILTERS

- Standard
MINI One (1.6 Petrol & 1.4 Diesel Auto 2003 on) & Cooper (1.6 Petrol to 07) **2C8285**
MINI One (1.4 Diesel Manual 2003 on) **2C8437**
Cooper S (1.6 Petrol 03/02 on) **2C8370**
MINI One (1.6 Petrol 07/04 on), Cooper (1.6 Petrol to 07/04) **2C8573**
Cooper S (1.6 Petrol 03/02 on)

K&N Replacement

- MINI One (petrol) & Cooper Up 06/04 **2C8285K-N**
- MINI One (Petrol) & Cooper From 07/04 **2C8437K-N**
- Cooper S **2C8370K-N**
- MINI One (diesel) **2C8437K-N**

K&N 57i INDUCTION KIT (Incs. Filter & Cold Air Hose)

- MINI One & Cooper Up To 11/06 **RBMW1014**
- Cooper S Up To 11/06 **RBMW1015**
- MINI One Diesel Up To 11/06 **RBMW1013**

K&N AIR FILTER CLEANING FLUID 1 Litre

RX1346

K&N AIR FILTER OIL

- 57cc Sachet **RX1347**
- 250ml Bottle **RX1348**
- 400ml Aerosol **RX1349**

OIL FILTERS

- All 1.6L Petrol Models **2C2253**
- MINI One MK2 1.4L Petrol from 04/07 and 1.6L Petrol from 11/06 on **2C2281**
- 1.4L Diesel from 2003 on **2C2022**
- 1.6L Diesel from 04/07 on **2C2256**

FUEL FILTERS

- 1.6L Diesel from 04/07 on **2C5110**
- 1.4L Diesel from 2003 on **2C5117**

CARBON ACTIVE (CABIN) FILTERS

- All Models Up To 11/06 **2CEC395**

SPARK PLUGS All Models

D25063

SPARK PLUGS - COPPER CORE All Models

- Ex Works **2N3199**
- Works **2N4285**

GLOW PLUGS Diesel Up To 11/06

2N5665

WIPER BLADES

- Driver Side Front (RHD) **C2X45**
- Passenger Side Front (RHD) **C2X48**
- Rear **C2X29P**

WIPER BLADES - SPOILER

- Driver Side Front (RHD) **C2VX45**
- Passenger Side Front (RHD) **C2VX48**

ALTERNATOR BELTS All Models Up To 11/06

2D6PK892

BRAKING
NEW MINI

BRAKE DISC All Models Up To 11/06

- Front Pair (Vented) **L3DF4197**
- Rear Pair (Solid) **L3DF4198**

'TURBO GROOVE' GROOVED & DIMPLED BRAKE DISC

- Front Pair (Vented) All Models Up To 11/06 **L3DF4197UR**
- Rear Pair (Solid) All Models Up To 11/06 **L3DF4198UR**

'ROSSINI' GROOVED & CROSS DRILLED BRAKE DISC

- Front Pair (Vented) All Models Up To 11/06 **L3DF4197 ROS**
- Rear Pair (Solid) All Models Up To 11/06 **L3DF4198 ROS**

BRAKE PADS

- Front All Models Up To 11/06 **L3GDB1476**
- Rear **L3GDB1477**
- Petrol Up To 03/03 **L3GDB1477**
- Petrol From 04/03 To 11/06 **L3GDB1561**
- Diesel Up To 11/06 **L3GDB1561**

'GREENSTUFF' KEVLAR BRAKE PADS

- Front All Models Up To 11/06 **L3GDB1476GS**
- Rear **L3GDB1477GS**
- Petrol Up To 03/03 **L3GDB1477GS**
- Petrol From 04/03 To 11/06 **L3GDB1561GS**
- Diesel Up To 11/06 **L3GDB1561GS**

BRAKE PAD WEAR INDICATOR & WIRE

- Front All Models Up To 11/06 **L3GIC185**
- Rear All Models Up To 11/06 **L3GIC186**

BRAKE CALIPER - Front All Models Up To 11/06

- LH **L3BHV566E**
- RH **L3BHV567E**

BRAKE HOSE

- Front All Models Up To 11/06 **L3PHD479**
- Rear All Models Up To 09/03 **L3PHD485**

GOODRIDGE STAINLESS STEEL BRAIDED HOSE KIT

- (Set Of 4) All Models Up To 09/03 **RBMW1003**
- (Set Of 4) All Models From 09/03 To 11/06 **RBMW1004**

CLUTCH
NEW MINI

CLUTCH KIT

- MINI One (Petrol) & Cooper Up To 06/04 **F3HK7794**
- MINI One (Petrol) & Cooper From 07/04 **F3HK2065**
- Cooper S From 08/02 **F3HK7851**

COOLING
NEW MINI

RADIATOR

- MINI One (Petrol) & Cooper - With Aircon **3N69700A**
- MINI One (Petrol) & Cooper - Exc. Aircon **3N69702A**
- Cooper - Heavy Duty - With Aircon **3N69703A**
- Cooper S **3N69701A**
- MINI One (Diesel) **3N69704A**

WATER PUMP

- Petrol Up To 11/06 **F3FWP1942**
- Diesel Up To 11/06 **F3FWP2035**

THERMOSTAT Diesel

F3FT545282

ELECTRICAL
NEW MINI

ENERGY BATTERY (3 Year Warranty) All Models

2P075

PRESTIGE BATTERY (4 Year Warranty) All Models

2P075SP

STARTER MOTOR

- MINI One (Petrol) & Cooper - Exc. Auto Trans. **L2LRT00234**
- MINI One (Petrol) & Cooper - Auto. Trans. **L2LRS01724**
- Cooper S **L2LRS01724**
- MINI One (Diesel) **L2LRS01965**
- Works 11/05 on **L2LRT00155**

ALTERNATOR

- MINI One (Petrol) & Cooper - 105A **L2LRA02297**
- MINI One (Petrol) & Cooper - 110A **L2LRA02908**
- Cooper S - 105A **L2LRA02907**
- MINI One (Diesel) **L2LRA02782**

CAMSHAFT SENSOR Diesel Up To 11/06

F4CS1297

LAMBDA SENSOR Petrol Up To 11/06

F4LB1891

EXHAUST
NEW MINI

INTERMEDIATE PIPE & REAR SILENCER

- MINI One (Petrol) Up To 04/04 **2B290161MINI**
- MINI One (Petrol) From 04/04 To 11/06 **2B290165MINI**
- Stainless Steel MINI One (Petrol) **2B290161SS**
- From 04/04 To 11/06 **2B290159MINI**
- Cooper Up To 04/04 **2B290167MINI**
- Cooper From 04/04 To 11/06 **2B290159SS**
- Stainless Steel Cooper From 04/04 To 11/06

FITTING KIT For Intermediate Pipe & Rear Silencer

- MINI One (Petrol) & Cooper **RBMW1001**

JANSPEED STAINLESS STEEL "CAT BACK"

EXHAUST SYSTEM - Twin 3.5" Centre Exit Tailpipes

- MINI Cooper S MK1 2002-2006 **RBMW1027**

MILLTEK STAINLESS STEEL FREE FLOW MANIFOLD & CATALYST

- MINI One, Cooper & Cooper S MK1 2002-2006 **RBMW1024**

MILLTEK STAINLESS STEEL "CAT BACK"

EXHAUST SYSTEM With Bracket Locators for '04 Cars

- Cooper S MK1 2002-2006 Exc. Cabriolet **RBMW1025**

MILLTEK FULL EXHAUST SYSTEM

- (Includes RBMW1024 & RBMW1025) **RBMW1026**
- Cooper S MK1 2002-2006 Exc. Cabriolet

MILLTEK STAINLESS STEEL LARGE BORE DOWN PIPE & FREE FLOW CATALYST

- Cooper S Turbo MK2 From 2006 **RBMW1021**

MILLTEK STAINLESS STEEL "CAT BACK" EXHAUST SYSTEM WITH TWIN OVAL TAILPIPES.

- Cooper S Turbo MK2 From 2006 **RBMW1022**

MILLTEK FULL EXHAUST SYSTEM

- (Includes RBMW1021 & RBMW1022) **RBMW1023**
- Cooper S Turbo MK2 From 2006

LIGHTING
NEW MINI

HEADLAMP ASSY (RHD)

- All Models, up to 04 **MLHL1112ARHD**
- Left **MLHR1112ARHD**
- Right
- All Models, 04 to 06 **MLHL1116ARHD**
- Left **MLHR1116ARHD**
- Right

REAR LAMP UNIT (RHD)

- All Models, up to 04 **MLRL1902U**
- Left **MLRR1902U**
- Right
- All Models, 04 to 06 **MLRL1906U**
- Left **MLRR1906U**
- Right

FOG LAMP ASSY (RHD)

- All Models, up to 06 **MLFL2001A**
- Left **MLFR2001A**
- Right
- All Models, 06 **MLFC2003A**
- Left & Right

FOG LAMP UNIT (RHD) less bulb & carrier

- All Models, up to 06 **MLFL2001U**
- Left **MLFR2001U**
- Right
- All Models, 06 **MLFC2003U**
- Left & Right

SIDE LAMP ASSY with bulb & carrier

- All Models, up to 04 **MLSC1403AY**
- Yellow Lens (RHD) Left & Right **MLSC1403AC**
- Clear Lens (RHD) Left & Right

SIDEPLATE (RHD)

- Cooper, 02 up to 06 **MLPL2502U**
- Left **MLPR2502U**
- Right

FRONT LAMP UNIT (RHD) less bulb & carrier

- Cooper, 02 up to 06 **MLFL1602U**
- Left **MLFR1602U**
- Right

HALO PROJECTOR HEADLAMPS - Pair

- All Models Up To 11/06 (E Approved And Road Legal) **RBMW1029**
- Chrome **RBMW1030**
- Black

HALO RING DESIGN INDICATOR AND SIDELIGHT ASSEMBLY - Pair

- All Models Up To 11/06 **RBMW1057**

STAINLESS STEEL DRIVING LAMPS 5" Dia. - Pair

- All Models Up To 11/06 **RX1556SS**

CHROME DRIVING LAMPS 5" Dia. - Pair

- All Models Up To 11/06 **RX1556**

L.E.D. DRIVING LAMPS

- All Models Up To 11/06 **RBMW1005**

DRIVING LAMP MOUNTING BRACKETS

- Suitable for use with L.E.D. Or Standard Driving Lamps
- Black All Models Up To 11/06 **RBMW1007**
- Stainless Steel All Models Up To 11/07 **RBMW1008**

CLEAR SIDE REPEATERS - Pair

- All Models Up To 11/06 **RBMW1034**

SHARKS GILL WING VENTS - Chrome

- Complete with Clear Side Repeaters - Pair **RBMW1032**
- All Models Up To 11/06

L.E.D. TAIL LAMPS - Pair All Models Up To 11/06

- Chrome **RBMW1009**
- Black **RBMW1010**

HEADLAMP BULB All Models

- Each **GLB472**
- Xenon - Pair **GLB472X**
- Osram Silver Star - Pair **GLB472 SILVER**
- Xenon Blue - Each **GLB472BLUE**

FRONT SIDE LAMP BULB - Each

- MINI One & Cooper **GLB501**
- L.E.D. MINI One & Cooper **GLB501LED**
- Cooper S **GLB233**

FRONT FOG LAMP BULB

- Each - MINI One & Cooper **GLB499**
- Osram Silver Star - Pair **GLB499 SILVER**
- MINI One & Cooper **GLB453**
- Each Cooper S

FRONT INDICATOR BULB - Each

- All Models **GLB382AMBER**
- L.E.D. All Models **GLB382LED AMBER**

TAIL LAMP BULB - Each

- All Models **GLB382**
- L.E.D. All Models **GLB382LED**

REAR INDICATOR BULB - Each

- All Models **GLB382**
- L.E.D. All Models **GLB382LED**

CONTINUED ON NEXT PAGE



NEW MINI

PRICES
SEE PAGES 124-151
OR VISIT OUR
WEBSITE

NEW MINI

REAR FOG LAMP BULB – Each

All Models
L.E.D. All Models

GLB382
GLB382LED

REVERSE LAMP BULB – Each

All Models
L.E.D. All Models

GLB382
GLB382LED

BRAKE LAMP BULB – Each

All Models
L.E.D. All Models

GLB380
GLB380LED

NUMBER PLATE LAMP BULB – Each

MINI One & Cooper
Cooper S

GLB207
GLB239

INTERIOR LAMP BULB – Each

MINI One & Cooper
Cooper S

GLB501
GLB239

STEERING & SUSPENSION

NEW MINI

BALL JOINTS All Models

Outer
LH
Inner RH

F3FBJ5428
F3FBJ5429
F3FBJ5430

WISHBONE All Models

LH
RH

F3FCA6188
F3FCA6189

WISHBONE BUSH All Models

With Housing LH
With Housing RH
Without Housing

F3FSK6418
F3FSK6419
F3FSK6420

STABILIZER LINK All Models

Front All Models Up To 03/02
Front All Models From 03/02
Rear All Models

F3FDL6609
F3FDL6610
F3FDL6611

FRONT GAS STRUT All Models From 03/02

LH
RH

2GG35452
2GG35453

REAR GAS SHOCK ABSORBER – LH & RH

All Models

2GG51281

FRONT COIL SPRING

MINI One Up To 11/06 – Exc. Cabriolet
MINI One & Cooper Up To 11/06 – Cabriolet
Cooper & Cooper S – Exc. Cabriolet
Cooper S Up To 11/06 – Cabriolet
MINI One Diesel Up To 11/06
Heavy Duty

2M01520002
2M01520004
2M01520001
2M01520005
2M01520003

MINI One Up To 11/06 – Exc. Cabriolet
MINI One & Cooper Up To 11/06 – Cabriolet
Cooper & Cooper S – Exc. Cabriolet

2M01520003
2M01520003
2M01520003

REAR COIL SPRING

MINI One Up To 11/06 – Exc. Cabriolet
MINI One & Cooper Up To 11/06 – Cabriolet
Cooper & Cooper S – Exc. Cabriolet
Cooper S Up To 11/06 – Cabriolet
MINI One Diesel Up To 11/06
Heavy Duty

2M01520001
2M01520003
2M01520001
2M01520003
2M01520002

MINI One Up To 11/06 – Exc. Cabriolet
Cooper & Cooper S – Exc. Cabriolet

2M01520002
2M01520002

SPAX "RSX" COIL-OVER KIT

MINI One & Cooper Up To VIN TE02415
MINI One & Cooper From VIN TE02416
Cooper S

RBMW1011
RBMW1012
RBMW1012

STEERING RACK All Models Up To 11/06

LH
RH

D3SR486

TRACK ROD END All Models Up To 05/03

LH
RH

F3FTR5023
F3FTR5024

POWER STEERING PUMP Diesel

D3SP1464

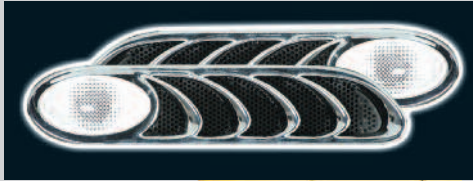

CHROME SHARKS GILL WING VENTS - RBMW1032

COLLISION PARTS

NEW MINI

FRONT BUMPER – With holes for Mouldings

Up To 07/04
Up To 07/04

RBMW1036
RBMW1037

BUMPER MOUNDINGS Up To 07/04

Chrome – LH
Chrome – RH
Primed – LH
Primed – RH

RBMW1039
RBMW1038
RBMW1041
RBMW1040

RADIATOR GRILLE Up To 07/04

Chrome
Primed

RBMW1042
RBMW1043

LOWER GRILLE SURROUND Up To 07/04

Chrome

RBMW1044

INNER FRONT PANEL

MINI One & Cooper Up To 11/06
Cooper S Up To 11/06

RBMW1045
RBMW1046

HEADLAMP RIM – No Wash Hole – Up To 11/06

LH
RH

RBMW1048
RBMW1047

FRONT WING Up To 11/06

LH
RH

RBMW1050
RBMW1049

BONNET

MINI One & Cooper Up To 11/06
Cooper S

RBMW1051
RBMW1060

DOOR MIRROR – Electric/Heated - Up To 11/06

LH
RH

RBMW1053
RBMW1052
RBMW1055
RBMW1054

'Autoback' – LH
'Autoback' – RH

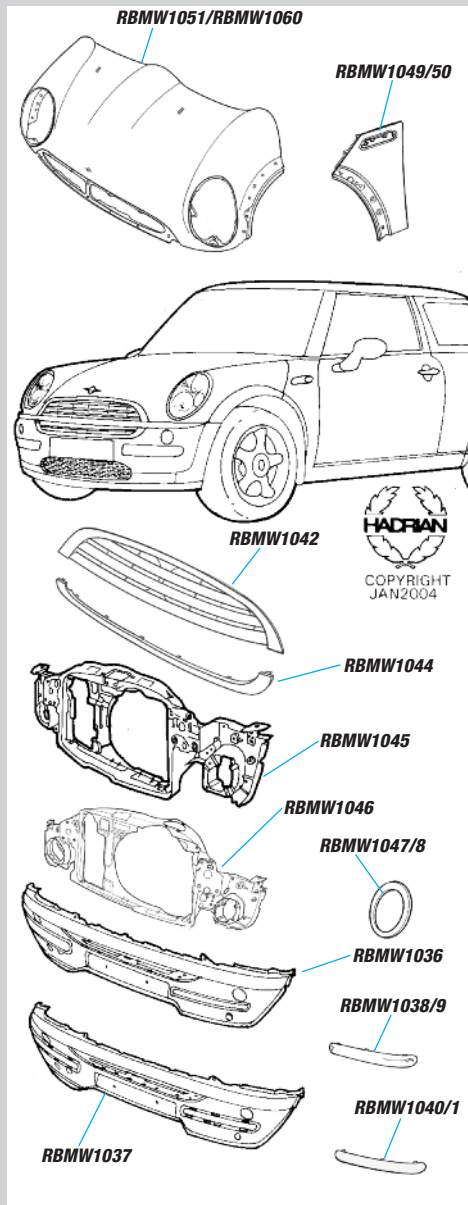

DRIVELINE

NEW MINI

CV JOINT Universal Stretch Boot LH & RH

All Models Up To 11/06

S2SB01

FRONT WHEEL BEARING

All Models Up To 11/06

S4R16250

REAR WHEEL BEARING

All Models Up To 11/06

S4R16251

ACCESSORIES

NEW MINI

HAYNES WORKSHOP MANUAL

All Models '00-'05

RBMW1002

HAYNES MAN MANUAL

RX1534

HAYNES MANUAL PROTECTOR

RX1569

HAYNES NEW MINI PERFORMANCE MANUAL

All Models

RBMW1020

"YOU AND YOUR NEW MINI" BOOK

All Models

RBMW1035

CHROME DOOR HANDLE "Garnishes" Pair

All Models

RBMW1028

CHROME DOOR MIRROR COVERS – Pair

All Models Up To 11/06

RBMW1031

CHROME SHARKS GILL SCUTTLE PANEL VENTS

Pair All Models Up To 11/06

RBMW1033

CHROME SHARKS GILL WING VENTS

Complete with Clear Side Repeaters – Pair

All Models Up To 11/06

RBMW1032

CLEAR SIDE REPEATERS – Pair

All Models Up To 11/06

RBMW1034

HALO PROJECTOR HEADLAMPS All Models Up To 11/06

Pair (E Approved and Road Legal)

Chrome
Black

RBMW1029
RBMW1030

STAINLESS STEEL DRIVING LAMPS 5" Dia. - Pair

All Models Up To 11/06

RX1556SS

CHROME DRIVING LAMPS 5" Dia. - Pair

All Models Up To 11/06

RX1556

L.E.D. DRIVING LAMPS

All Models Up To 11/06

RBMW1005

12V WIRING KIT

(Suitable for use with L.E.D. Or Standard Driving Lamps)

All Models Up To 11/06

RBMW1006

DRIVING LAMP MOUNTING BRACKETS

(Suitable for use with L.E.D. Or Standard Driving Lamps)

All Models Up To 11/06

Black
Stainless

RBMW1007
RBMW1008

UNION JACK KEYFOB

RX1545

DIS-CAR-NECT BATTERY ISOLATOR

(fits to battery terminal) All models

RX1356

OUTDOOR "MONSOON" SEMI-TAILORED CAR COVER

Exc. Cabriolet Up To 11/06

RBMW1056

CONSUMABLES & FLUIDS

NEW MINI

ENGINE OIL All Models

1 Litre
5 Litre

XPSYZ1L
XPSYZ5L

ANTI FREEZE 5 Litre All Models

XP5AF

CENTRAL HYDRAULIC FLUID

XPCHF11S

BRAKE FLUID

L3PFB440



CHROME DOOR HANDLE - RBMW1028

PLEASE NOTE!

Our range of 'New MINI' is continually expanding. For the latest additions or if you have a specific enquiry, please contact us.



PRICES
SEE PAGES 124-151
OR VISIT OUR
WEBSITE

MG METRO (1982 TO 1990)



SERVICE PARTS MG METRO (1982 TO 1990)

AIR FILTERS

Non Turbo
Turbo

12G3699EVA
27H2942EVA

OIL FILTERS All Models

SPARK PLUGS

Non Turbo
Turbo

GSP4362
GSP6462

DISTRIBUTOR CAPS

Non Turbo

Up To VIN 143404
From VIN 143405 To Vin 145347
Turbo, Up To VIN 145347
All Models From VIN XF400202

NJD000143EVA
ADU8532EVA
NJD000143EVA
ADU8814EVA

ROTOR ARMS

Non Turbo

Up To VIN 143404
From VIN 143405 To Vin 145347
Turbo, Up To VIN 145347

59321324EVA
NJE002123EVA
NJE002130EVA

POINTS Non Turbo

Up To VIN 143404

From VIN 143405 To Vin 145347

EDP109EVA

NJL000119EVA

ALTERNATOR BELTS All Models

12H3165EVA

BRAKING

MG METRO (1982 TO 1990)

BRAKE DISC, Front

Non Turbo,

Up To VIN 145347

From VIN XF400202

Turbo

SDB000364EVA
NAM6450EVA
NAM6450EVA

BRAKE PADS front (1 set) Up to 1984

Models Fitted With Teves Brakes

(Letter B under Bonnet)

SFP000259EVA

BRAKE SHOES rear (1 set) All Models

SFS10003EVA

WHEEL CYINDERS All Models

SML10003EVA

COOLING

MG METRO (1982 TO 1990)

RADIATORS

Up To VIN 145347
From VIN XF400202

PCC000211EVA
PCC000104EVA

THERMOSTATS All Models

THERMOSTAT GASKETS All Models

13H7604
12G330EVA

WATER PUMPS

With Bypass Outlet
Without Bypass Outlet

CAM4256SLP
PEB10036SLP

EXHAUST SYSTEM

MG METRO (1982 TO 1990)

DOWNPIPES

Non Turbo,

Up To VIN 145347

From VIN XF588617

Turbo, From VIN XF751612

WCD003911EVA
WCD033500EVA
GEX33428

REAR ASSEMBLIES

Non Turbo, Up To VIN 145347

WCG003913EVA

STEERING & SUSPENSION

MG METRO (1982 TO 1990)

BALL JOINTS, front (Upper & Lower)

Up To VIN 145347
From VIN XF400202

NAM4376EVA
RBG000020SLP

UPPER ARM FULCRUM SHAFT REPAIR KIT

All Models

2A4325KP

TRAILING ARM PIVOT KIT All Models

RHM001173EVA

TRACK ROD ENDS All Models

QJB10004EVA

SHOCK ABSORBERS, front All Models

ADU3076EVA

COLLISION PARTS

MG METRO (1982 TO 1990)

BUMPER FRONT (Primer) All Models

Front

Rear

JPC9110LML
JPC9111LML

DOOR SKIN All Models

RH

LH All Models

BDA39014
BDA39015

NOTES





ROVER 100 / METRO (APRIL 1990 ON)

PRICES
SEE PAGES 124-151
OR VISIT OUR
WEBSITE



SERVICE PARTS

ROVER 100 / METRO (APRIL 1990 ON)

AIR FILTERS

- 1.1/1.4 Petrol, SPI
- 1.4 Petrol, MPi
- 1.1/1.4 Petrol, Carb.
- Diesel
- 1.5 Diesel

PHE10002EVA
PHE000121
PHE10003EVA
PHE10022EVA
PHE100370EVA

FUEL FILTERS

- Petrol, All models - exc: 1.1/1.4 MPi (8V)
- 1.1/1.4 Petrol (8V) - MPi
- Diesel, All models

WJN101520EVA
WJN101191
MUN10001EVA

OIL FILTERS

- Petrol, All models
- Diesel, All models

LPW100181
LRF10002EVA

GLOW PLUGS

- 1.4 Diesel
- 1.5 Diesel

NCC10002
NCC100100
NLP000040

SPARK PLUGS All models

WIPER BLADES

- Blade-windscreen wiper - RH & LH
- Blade-backlight wiper

DKC000041EVA
DKC000041EVA

FUEL PUMPS

- 1.1/1.4 Petrol, mechanical
- 1.1/1.4 Petrol (8V/16V) - SPI
- 1.1/1.4 Petrol (8V) - MPi
- 1.1/1.4 Petrol (16V) - MPi - GTi 16V (Upright)
- 1.4 Diesel, fuel injection
- 1.5 Diesel, fuel injection - 10FY6C

WND10004
WFX10025
WFX100860
WFX10038
MSR10010
MSR100290

TIMING BELTS

- 1.1/1.4 Petrol (8V)
- 1.4 Petrol (16V)
- 1.4 Diesel
- 1.5 Diesel

WAM2804
CDU2749
LHN10022EVA
LHN100460EVA

TIMING BELT KIT

- 1.1/1.4 Petrol (8V) (includes belt & tensioner)
- 1.4 Petrol (16V) (includes belt & tensioner)
- 1.5 Diesel (includes belt, tensioner & idler)

RP1070
RP1071
RP1072

ALTERNATOR BELTS

- 1.1/1.4 Petrol (8V) - MPi
- 1.1/1.4 Petrol (8V) - SCSP
- 1.1/1.4 Petrol (8V) - SPI - exc: air-con
- 1.4 Petrol (16V)
- 1.4 Diesel
- 1.5 Diesel

PQS100840
PQS10028EVA
PQS10013EVA
PQS10013EVA
PQS010700EVA
PQS100980EVA

DISTRIBUTOR CAPS

- Petrol, All models - exc: Carb.
- 1.1/1.4 Petrol (8V) - Carb.

NJD10010
ADU8814EVA

ROTOR ARMS

- Petrol, All models - exc: Carb.
- 1.1/1.4 Petrol (8V) - Carb.

NJE100070
RTC3990EVA

BRAKING

ROVER 100 / METRO (APRIL 1990 ON)

BRAKE DISC, front each

- All models - exc: MPi
- MPi

SDB090811SLP
NAM7806

BRAKE PADS, front (1 Set) All models

SFK10004EVA

BRAKE SHOES, rear (1 Set) All models

SFS10003EVA

BRAKE WHEEL CYLINDERS All models

SML10003EVA

HANDBRAKE CABLES All models

SPB10033EVA

ENGINE

ROVER 100 / METRO (APRIL 1990 ON)

EXHAUST VALVE 1.1 & 1.4 Petrol, 8V Models

LGH101180SLP

CAM COVER CASKET 1.1-1.4 Petrol (8V)

LVP100390

CYLINDER HEAD BOLT 1.1 & 1.4 Petrol

WAM2293

GASKET

- Upper Inlet Manifold to lower Inlet Manifold

1.4 Petrol (16V)

LKJ10028EVA

- Lower Inlet Manifold to Cylinder Head

1.4 Petrol (16V)

LKJ10029EVA

SUMP ASSEMBLY

- 1.1 - 1.4 Petrol Early (check Engine No.)

LSB101260

SUMP GASKET

- 1.1 - 1.4 Petrol Early (Check Engine No.)
- 1.1 - 1.4 Petrol Late (Check Engine No.)

CDU1890EVA
LVF100290

CLUTCH

ROVER 100 / METRO (APRIL 1990 ON)

CLUTCH KITS

- 1.1 Petrol (8V) - MPi, manual
- 1.4 Petrol (16V)
- 1.4 Diesel
- 1.5 Diesel

URF009100EVA
URF009065EVA
URF006338EVA
URF006557EVA

CLUTCH COVERS Not available separately see clutch kits

CLUTCH PLATES Not available separately see clutch kits

CLUTCH RELEASE BEARINGS All models

UTJ100100

COOLING

ROVER 100 / METRO (APRIL 1990 ON)

RADIATORS

- Petrol, up to BD110565 - exc: 1.4 Petrol auto.

1.4 Petrol, auto., up to BD110565 - exc: Japan

Japan only

Petrol, from BD110566

Diesel, up to AD999999

Diesel, from BD1001

PCC001086EVA

PCC001086EVA

PCC105130EVA

PCC001085EVA

PCC001086EVA

PCC104600EVA

THERMOSTATS

- 1.1/1.4 Petrol (8V/16V) - Carb./SPI, up to AD687992

from AD687993 to eng.455449

1.1/1.4 Petrol (8V) - Carb./MPi/SPI, from eng.455450

Diesel, All models

PEL000322EVA

PEL10007EVA

PEL10016

PEL10019EVA

WATER PUMPS

1.1/1.4 Petrol (8V)

1.4 Petrol (16V)

1.4 Diesel

1.5 Diesel

PEB000080SLP

PEB102510SLP

PEB10143

PEE002710EVA

PIPES & HOSES

Rigid coolant pipe - thermostat to bottom hose

1.1/1.4 Petrol

PEP102160

ELECTRICAL

ROVER 100 / METRO (APRIL 1990 ON)

BATTERIES

Petrol, manual

Diesel

YGD100810

ZUA000063E

ENGINE SENSORS

Sensor - Oxygen - Multi point injection

1.1/1.4 Petrol (V8)

MHK10006





PRICES
SEE PAGES 124-151
OR VISIT OUR
WEBSITE

ROVER 100 / METRO (APRIL 1990 ON)



LIGHTING

ROVER 100 / METRO (APRIL 1990 ON)

HEADLAMPS

RHD vehicles *All models*

RH, up to AD999999

LH, up to AD999999

RH, from BD1001 -

exc: Headlamp levelling

LH, from BD1001 -

exc: Headlamp levelling

RH, Headlamp levelling

LH, Headlamp levelling

RH, up to AD999999 -

exc: Headlamp levelling

LHD vehicles *All models*

RH, Headlamp levelling, up to AD999999

RH, from BD1001 -

exc: Headlamp levelling

LH, from BD1001 -

exc: Headlamp levelling

RH, from BD1001, Headlamp levelling

LH, from BD1001, Headlamp levelling

INDICATOR LAMPS

RH, up to AD999999

LH, up to AD999999

REAR LAMPS *All models*

RH, up to AD999999

RH, from BD1001

LH, up to AD999999

LH, from BD1001

HEADLAMP BULBS

H4-60/65 Watt - Clear

Capless, clear - Bulb-501, w10/5-5 Watt

INDICATOR LAMP BULBS

Clear, up to AD999999 -

Bulb-382, p25/1-21 Watt

Yellow, direction indicator, from BD1001

Bulb-344, 21 Watt

REAR LAMP BULBS

Bulb-380, 21/5 Watt

Clear - Bulb-382, p25/1-21 Watt

CLEAR SIDE REPEATER LAMP CONVERSION KIT

Includes 2 clear side repeater lamps and bulbs

All models

XBC10170P

XBC10171

XBC103460

XBC103470

XBC104680

XBC104690

XBC10172

XBC105420

XBC103480

XBC103490

XBC104700

XBC104710

ZUA000380 + XBY10002

ZUA000390 + XBY10002

XFB10062

XFB101060

XFB10063

XFB101070

XZQ000150

AFU4481

GLB382

XZQ100190L

GLB380

GLB382

RP1042

STEERING & SUSPENSION

ROVER 100 / METRO (APRIL 1990 ON)

BALL JOINTS

Upper Ball Joint

Upper Arm Fulcrum Shaft Repair Kit

Lower Ball Joint

all exc. 1.4 GTA

1.4 GTA - RH

1.4 GTA - LH

FRONT LOWER WISHBONE

Complete assembly RH

Complete assembly LH

Front bush LH & RH

Rear bush LH & RH

TRAILING ARM ASSEMBLY, rear *All models,*

RH

LH

TRAILING ARM PIVOT KIT *All models,*

LH & RH

STEERING RACK 155 radial ply tyres

TRACK ROD ENDS 155 radial ply tyres

STEERING RACK GAITER KIT *All models*

SHOCK ABSORBERS

front GTI 16V (Upright) - sports suspension

Spax Adjustable

front or rear pair *All models*

DRIVE SHAFT GAITER KIT

inner *All models, manual*

inner *All models, auto.*

outer *All models*

FRONT SUBFRAME MOUNTING

Front

Rear

REAR SUBFRAME MOUNTING

RH

LH

WHEEL BEARING KIT

front *All models*

rear *Kit-hub bearing & oil seal*

RH

LH

COLLISION PARTS

ROVER 100 / METRO (APRIL 1990 ON)

DOOR SKIN

5 Door models

RH Front

LH Front

RH Rear

LH Rear

3 Door models

RH

LH

FUEL TANK *Single Carb models*

TAILGATE SPOILER - Black

GTA/GTi models

RBG000020SLP

2A4325KP

NAM9425EVA

NAM9462EVA

NAM9463EVA

RBJ10034SLP

RBJ10035SLP

RBX10025

RBX000770

RGG10202

RGG10203

RHM10001EVA

QEB003337EP

QJB000733EVA

QBZ10001

NAM9003EVA

RP1023SPAX

EJP1509

TDR000200

TDR000140

NAM3620

KGE10001

KHC10010P

KHC10011

RFM000050SLP

RFM001807EVA

RFM001806EVA

BDA39016

BDA39017

BFA39010

BFA39011

BDA39014

BDA39015

WFE104760

DFD10083PML

PROTECTION & STOWAGE

ROVER 100 / METRO (APRIL 1990 ON)

MUD GUARDS

Black

Front Pair *All models*

Rear Pair *All models*

Grey

Front Pair *All models*

Rear Pair *All models*

CAS100570PMD

CAT100660PMD

CAS100570LOG

CAT100660LOG

TOURING

ROVER 100 / METRO (APRIL 1990 ON)

ESSENTIALS XTRA KIT *All models*

XPT000138ACA

INTERIOR CARE XTRA KIT *All models*

XPT000139ACA

ESSENTIALS & INTERIOR CARE KIT *All models*

Includes XPT000138ACA & XPT000139ACA

RP1017

POWER SOURCE INVERTER - converts 12V DC into 240V AC

150 watt model *All models*

300 watt model *All models*

500 watt model *All models*

RX1551-150

RX1551-300

RX1551-500

SAFETY

ROVER 100 / METRO (APRIL 1990 ON)

FIRE EXTINGUISHER

600gm Red Alloy *All models*

Red, Powder, 1Kg *All models*

S3SSFE1

GAC9904X

PARKING AID UNIVERSAL KIT *All models*

including 4 sensors and all fittings

RX1559

WARNING TRIANGLE *Universal All models*

RX1344

SAFETY VEST (luminous) *All models*

GAC2999

LITERATURE

ROVER 100 / METRO (APRIL 1990 ON)

HAYNES WORKSHOP MANUAL

111 & 114 1990-1998

RP1008

HAYNES "MAN" MANUAL - 128 pages,

Health Guide in style of Workshop Manual

RX1534

HAYNES MANUAL PROTECTOR

RX1569

NOTES



ORDER

BY PHONE: 01522 568000 / ON LINE: www.rimmerbros.co.uk / E-MAIL: mgrover@rimmerbros.co.uk



ROVER 200 (1995 ON)

PRICES
SEE PAGES 124-151
OR VISIT OUR
WEBSITE



SERVICE PARTS

ROVER 200 (1995 ON)

AIR FILTERS All models

Petrol
Diesel

PHE000121
PHE100331

FUEL FILTERS All models

Petrol
Diesel

WJN101191
WJN000130

OIL FILTERS All models

Petrol
Diesel

LPW100181
ERR5542

CRANKSHAFT FRONT OIL SEAL

2.0 Diesel

AHU2198

POLLEN FILTERS All models

GLOW PLUGS Diesel, All models

SPARK PLUGS

1.1/1.4/1.6 Petrol
1.8 Petrol

NLP000040
NLP100290

WIPER BLADES

Blade-windscreen wiper,
RH & LH, RHD vehicles
RH & LH, LHD vehicles
Blade-backlight wiper

DKC10002
DKC10003
DKC101070

FUEL PUMPS All models

Petrol,
Diesel, do not use with fuel tank WFE107010

WFX101010
WFX100691

TIMING BELTS

1.1/1.4 Petrol (8V)
1.1/1.4/1.6/1.8 Petrol (16V),
26mm wide - exc: VVC
1.4/1.6/1.8 Petrol (16V), 23mm wide - exc: VVC
1.6/1.8 VVC, front
1.6/1.8 VVC, rear
2.0 Diesel

WAM2804
LHN100560
CDU2749
LHN100390
LHN100400
LHN10029

TIMING BELT KIT (includes belt & tensioner)

1.1/1.4 Petrol (8V)
1.1/1.4/1.6/1.8 Petrol (16V),
26mm wide - exc: VVC
1.4/1.6/1.8 Petrol (16V), 23mm wide - exc: VVC
1.6/1.8 VVC

RP1070
RP1078
RP1071
RP1079

ALTERNATOR BELTS

Petrol - exc: air-con
Petrol, air-con only
Diesel - exc: air-con
Diesel, air-con only

PQS100840
PQS100940
PQS101030
PQS100851

DISTRIBUTOR CAPS All models

ROTOR ARMS All models

NJD10010
NJE100070SLP

BRAKING

ROVER 200 (1995 ON)

BRAKE DISC

front each Solid
front each Vented
rear each Solid All models

SDB100500
SDB000990
EGP1254

BRAKE PADS (1 Set)

front Solid
front Vented
rear Solid All models

SEB000290SLP
SFP000390
EJP1437

BRAKE WHEEL CYLINDERS rear All models

RH
LH

SML100080
SML100090

BRAKE SHOES, rear (1 Set) All models

HANDBRAKE CABLES

Drum brakes - rear,
RH
LH
Disc brakes-rear
RH
LH

SFB000340
SPB000350
SPB000370
SPB000360

ENGINE

ROVER 200 (1995 ON)

CYLINDER LINER K series Engine Models LCJ000050SLP

SEALANT For Use when Fitting Cylinder Liner

K series Engine Models

GGC102

CYLINDER HEAD BOLT 1.1/1.4/1.6/1.8 Petrol WAM2293

SEAL-CAMSHAFT OIL

Black, front 1.1-1.4-1.6-1.8 Petrol
Red, rear 1.1-1.4-1.6-1.8 Petrol
Front & Rear 2.0 Diesel

LUC100290SLP
LUC100220SLP

CAM COVER GASKET 1.1-1.4 Petrol (8V)

HEAD GASKET SET 2.0 Diesel

Head Gasket not included due to variable Thickness.

LVP100390
LVQ101010

HEAD GASKET ONLY 2.0 Diesel

1.05MM.Thickness - 1 HOLE
1.20MM.Thickness - 2 HOLE
1.35MM.Thickness - 3 HOLE

LVB100910
LVB100920
LVB100930

SUMP GASKET 1.1 - 1.4 Petrol

LVF100290



CLUTCH KIT - URF000170

CLUTCH

ROVER 200 (1995 ON)

CLUTCH CABLES

1.1/1.4/1.6 Petrol - RHD vehicles
1.1/1.4/1.6 Petrol - LHD vehicles
1.8 Petrol - RHD vehicles
1.8 Petrol - LHD vehicles
2.0 Diesel - RHD vehicles
2.0 Diesel - LHD vehicles

UUC101240
UUC101250
UUC101260
UUC101270
UUC101260
UUC101270

CLUTCH KITS

1.1/1.4/1.6 manual Petrol - exc: VVC
1.6 (16V) - VVC/1.8 Petrol
2.0 Diesel, TcIe
2.0 Diesel, TCIeM

URF000170
URF000121
URF000131
URF000060

COOLING

ROVER 200 (1995 ON)

RADIATORS

1.1/1.4/1.6 Petrol, manual,
up to AD70220 - exc: air-con
air-con only
1.6 Petrol, auto.
1.8 Petrol
Diesel, All models

PCC104671
PCC104671
PCC104671
PCC104671
PCC113541SLP
JRB100310SLP

AIR CON CONDENSER All models

THERMOSTATS

Petrol, All models
Diesel 2.0

PEL10016
PEM101020

WATER PUMPS

1.1/1.4 Petrol (8V)
1.4 (16V)/1.6 (16V)/1.8 Petrol,
less evaporation chamber - exc: VVC
1.6 (16V) - VVC/1.8 Petrol,
with evaporation chamber
2.0 Diesel

PEB000080SLP
PEB102510SLP
PEB102510SLP
PEB102420

RIDGED COOLANT PIPE - thermostat to bottom hose

1.1/1.4/1.6/1.8 Petrol

PEP102160

ELECTRICAL

ROVER 200 (1995 ON)

ENGINE SENSORS

Sensor - Oxygen multi point insection
1.1/1.4/1.6/1.8 Petrol
Sensor - Crank
1.1/1.4/1.6/1.8 Petrol

MHK10006
NSC100760

EXHAUST SYSTEM

ROVER 200 (1995 ON)

DOWNPIPES

1.1/1.4 Petrol (8V)
1.1/1.4 Petrol (16V)
1.6 Petrol, manual
1.6 Petrol, auto.
1.8 Petrol
2.0 Diesel

WCD105700
WCD104220
WCD104200
WCD104210
WCD104240
WCD104840

CATALYTIC CONVERTERS

1.1/1.4/1.6 Petrol
1.8 Petrol - exc: Germany
1.8 Petrol, Germany only
2.0 Diesel, up to WD393342
2.0 Diesel, from WD393343

WAG103761SLP
WAG104070SLP
WAG103761SLP
WAG103260SLP
WAG104790

INTERMEDIATES

1.1/1.4/1.6 Petrol, manual
1.6 Petrol Japan, auto., up to YD471564
1.6 Petrol, auto. - exc: Japan
1.6 Petrol, auto., Japan only
1.8 Petrol - exc: Japan
1.8 Petrol, Japan
1.8 Petrol, Japan only
2.0 Diesel

WCE103240
WCE103380
WCE103240
WCE103380
WCE103410
WCE103420
WCE103420
WCE103290

REAR ASSEMBLIES

1.1, 1.4 Petrol, less chrome tail pipe
1.4/1.6 Petrol, chrome tail pipe
1.6 (16V) Petrol
1.8 Petrol, less chrome tail pipe
2.0 Diesel

WCG102450
WCG108540
WCG102450
WCG102980
WCG102470





PRICES
SEE PAGES 124-151
OR VISIT OUR
WEBSITE

ROVER 200 (1995 ON)



ROVER 200

LIGHTING

ROVER 200 (1995 ON)

HEADLAMPS

RHD All models

RH - exc: headlamp levelling
RH - exc: headlamp levelling
RH - headlamp levelling
LH - headlamp levelling

XBC10286
XBC10287
XBC104140
XBC104150

LHD All models

RH - exc: headlamp levelling
LH - exc: headlamp levelling
RH - headlamp levelling
LH - headlamp levelling

XBC10288
XBC10289
XBC10290
XBC10291

CLEAR SIDE REPEATER LAMP CONVERSION KIT

Includes 2 Clear Side repeater lamps & 2 Amber Bulbs

All Models

RP1042

REAR LAMPS All models,

RH
LH

XFB10088
XFB10089

TECHNO DESIGN LED REAR LAMPS (Pair) All models

Red/Clear

XPT000094ACAPTECHNO

Black All models

XPT000094ACAPTECHBLK

HEADLAMP BULBS

H4-60/65 Watt - Clear. Main/Dip
Capless sidelamp, clear -

XZQ000150

Bulb-501, w10/5-5 Watt

GLB501

Indicator, clear - Bulb-382, p25/1-21 Watt

GLB382

INDICATOR LAMP BULBS Capless, clear side repeater -

Bulb-501, w10/5-5 Watt

GLB501

REAR LAMP BULBS

10 Watt - Bulb-245-r19/10-10 Watt

GLB245

21 Watt, Clear - Bulb-382, p25/1-21 Watt

GLB382

STEERING & SUSPENSION

ROVER 200 (1995 ON)

TRACK CONTROL ARM All models,

RH
LH

RBJ100781
RBJ100791

TRACK CONTROL ARM BUSH

All models, RH & LH

EGP1673

ANTI ROLL BAR LINK All models, RH & LH

EGP1662

DRIVE SHAFT GAITER KIT

inner

1.1/1.4/1.6 Petrol, manual
1.6 auto./1.8 Petrol
2.0 Diesel

EJP1509
TDR000200

TDR000230

outer

Petrol, All models
2.0 Diesel

TDR000140
BAU5441

SHOCK ABSORBERS

front

1.1/1.4/1.6 Petrol
1.8 Petrol - exc: BRM Badge
1.8 Petrol, manual, BRM Badge,
standard suspension
2.0 Diesel

RND103470
RND103490

RND105220
RND103480

rear

1.1/1.4/1.6 Petrol
1.8 Petrol, sports suspension,
up to WD277410 - exc: BRM Badge
from WD277411 - exc: BRM Badge
1.8 BRM Badge Petrol, VVC
2.0 Diesel, heavy duty suspension

RPD101700

RPD101720

RPD102580

RPD102680

RPD101710

STEERING RACK GAITER KIT

Power Steering - All models
Manual Steering - All models

QEY000050
QEY10002

TRACK ROD ENDS All models,

up to YD461772
from YD461773

QJB100120
QJB100240

WHEEL BEARING KIT

front All models

rear All models - exc: A.B.S.

rear A.B.S., with disc rear brakes

rear A.B.S., with drum rear brakes

RFM000060

RLB000050

RLB000060

RLB000070

COLLISION PARTS

ROVER 200 (1995 ON)

BONNET All models

FRONT BUMPER

All models - exc: BRM Badge

BKA450050

DPC101490LML

FRONT PANEL

Front Panel Assembly
Headlamp mounting,
RH

ABB45001

ABB45002

ABB45003

LH

Bonnet slam panel

Bracket, centre stay

Cross member, lower

ABG45001

ABU45002

ABC450050

FRONT WING All models,

RH

LH

ASB45002

ASB45003

GRILLE All models - exc: BRM Badge

DHB102380SLP

REAR BUMPER

All models - exc: BRM Badge

DQC101211LML

All models - BRM Badge

DQB102410WAI

REAR PANEL All models

AQA470010

PROTECTION & STOWAGE

ROVER 200 (1995 ON)

HEADLAMP PROTECTOR KIT All models

XBV100390

MUD GUARDS All models (exc. Where side sills are fitted)

Front Pair

CAS100270PMA

Rear Pair

CAT100540PMA

TOURING

ROVER 200 (1995 ON)

TOWING MIRROR All models

CRB108270

TRAILER / REAR LIGHTING BOARD, 4ft Inc cable

All models

RX1513

ESSENTIALS XTRA KIT All models

XPT000138ACA

INTERIOR CARE XTRA KIT All models

XPT000139ACA

ESSENTIALS & INTERIOR CARE KIT All models

RP1017

Includes XPT000138ACA & XPT000139ACA

POWER SOURCE INVERTER - converts 12V DC into 240V AC

150 watt model

RX1551-150

300 watt model

RX1551-300

500 watt model

RX1551-500

TOWING ELECTRICS (13 pin European)

All models

VUB104560

SAFETY

ROVER 200 (1995 ON)

FIRE EXTINGUISHER All models

600gm Red Alloy
Red, Powder, 1Kg

S3SSFE1
GAC9904X

PARKING AID UNIVERSAL KIT All models

Including 4 sensors and all fittings

RX1559

WARNING TRIANGLE Universal All models

RX1344

SAFETY VEST (luminous) All models

GAC2999

LITERATURE

ROVER 200 (1995 ON)

OWNERS HANDBOOKS

All models vin 183 to vin 4458

All models vin 113385 to vin 455992

RCL0003ENG

RCL0245ENG

HAYNES WORKSHOP MANUAL

211, 214, 216, 218 & 220 1995-1998

RP1003

LITERATURE HAYNES "MAN" MANUAL - 128 pages,

Health Guide in style of Workshop Manual

RX1534

HAYNES MANUAL PLASTIC COVER

RX1569

WHEELS & FITTINGS

ROVER 200 (1995 ON)

ALLOY WHEEL NUT non locking All models

up to AD83100
from AD83101

DBP7829
RRD100500

WHEEL CLEANING BRUSH (Fir Tree Shape)

KACB101

MWS ALLOY WHEEL CLEANING KIT

RX1405

AUTOGLYM CLEAN WHEELS Alloy Wheel Cleaner

500ml

RX1322

AUTOGLYM ALLOY WHEEL SEAL 450ml

RX1443

RIMWAX Professional Wheel Polish and Sealer

RX1262

AUTOGLYM INSTANT TYRE DRESSING

RX1368

TYRE WELD Puncture Repair (Holts Brand)

300ml

GAC9903X-300ML

400ml

GAC9903X-400ML

DIGITAL TYRE PRESSURE GAUGE

XPT000006ACA

TYRE TREAD DEPTH GAUGE

27298

NOTES



MUD GUARDS
FRONT PAIR - CAS100270PMA
REAR PAIR - CAT100540PMA



ROVER 200 / 400 (1992 - 1996)

PRICES
SEE PAGES 124-151
OR VISIT OUR
WEBSITE



SERVICE PARTS

ROVER 200 / 400 (1992-1996)

AIR FILTERS

1.4 Petrol 8V
1.4 Petrol 16V
1.6 Petrol, All models
2.0 Petrol
Diesel, all models

PHE10002EVA
PHE000121
FDU1632EVA
PHE000121
PHE10004EVA

FUEL FILTERS

Petrol, All models - exc: 1.6 Petrol
1.6 Petrol
Diesel, all models

WJN101520EVA
WJN10010EVA
WJN100650EVA

OIL FILTERS

1.4 Petrol
1.6 Petrol
2.0 Petrol - exc: Turbo
2.0 Petrol Turbo
Diesel, all models

LPU100181
LRF000020
ADU7417
ADU9826EVA
LRF10002EVA

CRANKSHAFT FRONT OIL SEAL

2.0 Petrol & Diesel

AHU2198

GLOW PLUGS Diesel, all models

NCC10001

SPARK PLUGS

1.4 Petrol
1.6 Petrol - DOHC
1.6 Petrol - SOHC
2.0 Petrol - exc: Turbo

NLP000040
NLP000040
2N3132
NLP000040

WIPER BLADES

RHD vehicles Windscreen wiper,
RH & LH, All models - exc: Turbo
RH, 2.0 Petrol Turbo
LH, 2.0 Petrol Turbo

DKC10002
DKC000045SLP
DKC10002

RHD vehicles Backlight wiper,
All models

DKC000045SLP

LHD vehicles Windscreen wiper,
RH & LH, All models - exc: Turbo
RH, 2.0 Petrol Turbo
LH, 2.0 Petrol Turbo

DKC101070
DKC101070
DKC000045SLP

LHD vehicles Backlight wiper,
All models

DKC000045SLP

FUEL DELIVERY

In Tank Fuel Pump & Sender Unit

1.4 Petrol 8V
1.4 Petrol 16V
1.6 Petrol All models
2.0 Petrol - exc: Turbo
2.0 Petrol Turbo

WFX100590
WFX10027
WFX10022
WFX10027
WFX10033
RP1104

Electric Pump Only 1.4 16V

Fuel Injection Pump
1.7 Diesel
1.9 Diesel

MSR10014
MSR10013

TIMING BELTS

1.4 Petrol 8V
1.4 Petrol 16V
1.6 Petrol - SOHC
1.6 Petrol - DOHC
2.0 Petrol
Diesel, all models

WAM2804
CDU2749
FDU1466
FDU1464EVA
LHN10016
LHN10015EVA

TIMING BELT KIT (includes belt & tensioner)

1.4 Petrol 8V
1.4 Petrol 16V
1.6 Petrol - SOHC
1.6 Petrol - DOHC
2.0 Petrol

RP1070
RP1071
RP1073
RP1074
RP1080

ALTERNATOR BELTS

1.4 Petrol - exc: air-con
1.4 Petrol, air-con
1.6 Petrol, up to AD605481
1.6 Petrol, from AD605482
2.0 Petrol - exc: air-con
2.0 Petrol, air-con
Diesel, All models

PQS10013EVA
PQS100940
FDU1817EVA
PQS10065EVA
PQS101590
PQS10035
PQS10043EVA

DISTRIBUTOR CAPS

1.4/2.0 Petrol
1.6 Petrol - DOHC
1.6 Petrol - SOHC

NJD10010
NJD100140EVA
NJD100130EVA

ROTOR ARMS

1.4/2.0 Petrol
1.6 Petrol, All models

NJE100070
NJE100050EVA

BRAKING

ROVER 200 / 400 (1992-1996)

BRAKE DISC - front each

1.4 Petrol, 238mm diameter,
up to BD234417/908975 - exc: A.B.S.
1.4 Petrol, 262mm diameter,
from BD234418/908976 - exc: A.B.S.
1.4 Petrol, A.B.S., up to BD240000/903000
1.4 Petrol A.B.S., from BD240001/903001
1.6 Petrol, up to BD240000/903000
1.6 Petrol, from BD240001/903001
2.0 Petrol, up to BD240000/903000
2.0 Petrol, from BD240001/903001
Diesel, all models, up to BD240000/903000
Diesel, all models, from BD240001/903001

EJP7368SLP

SDB100500
EJP9579SLP
SDB000990
EJP9579SLP
SDB000990
EJP9579SLP
SDB000990
EJP9579SLP
SDB000990
EGP1254

BRAKE DISC - rear (1Set) All models

BRAKE PADS front (1 Set)

1.4 Petrol - exc: A.B.S.
1.4 A.B.S./1.6/2.0 Petrol
All models, fitted with Drum brakes-rear -
exc: A.B.S.
Diesel, All models
rear (1 Set) All models

SFP100200EVA
SFP000390
SEB000290SLP
SFP000390
EJP1437
SFS100090

BRAKE SHOES, rear (1 Set) All models

BRAKE WHEEL CYLINDERS, rear All models, RH LH

EJP1489

EJP1488

HANDBRAKE CABLES

Drum brakes-rear
RH
RH
LH
Disc brakes-rear
RH
LH

SPB10010EVA
SPB10015EVA

SPB10011EVA
SPB10016EVA

ENGINE

ROVER 200 / 400 (1992-1996)

CAM COVER GASKET 1.4 Petrol (8V)

LVP100390

CYLINDER HEAD BOLT 1.4 Petrol

WAM2293

GASKET

Upper Inlet Manifold to Lower Inlet Manifold
1.4 Petrol (16V)

LKJ10028EVA

Lower Inlet Manifold To Cylinder Head
1.4 Petrol (16V)

LKJ10028EVA

BOTTOM END GASKET SET 1.4 Petrol

LVQ10012EVA

SUMP ASSEMBLY

1.4 Petrol Early (Check Engine No.)

LSB101260

SUMP GASKET

1.4 Petrol Early (Check Engine No.)
1.4 Petrol Late (Check Engine No.)

CDU1890EVA
LVF100290

ENGINE MOUNTINGS Right Hand 1.4 Petrol

KKG10015



CLUTCH

ROVER 200 / 400 (1992-1996)

CLUTCH CABLES

RHD vehicles
1.4 Petrol
1.6 Petrol
2.0 Petrol
Diesel, All models
LHD vehicles
1.4 Petrol
2.0 Petrol
Diesel, All models

UUC101240
UUC10054EVA
UUC10062EVA
UUC10052EVA

UUC101250
UUC10049EVA
UUC10019EVA

CLUTCH KITS

1.4 Petrol - Valeo Type
1.4 Petrol - AP Borg and Beck Type
1.6 Petrol
2.0 Petrol - exc: Turbo
2.0 Petrol Turbo
Diesel, all models

URF009065EVA
URF009065EVA
URF009203EVA
URF000121
URF000190
URF009775EVA
URB10009

CLUTCH COVER 2.0 Petrol - exc: Turbo

CLUTCH PLATES

2.0 Petrol - exc: Turbo
Diesel, all models

UQB000221
UQB10017

CLUTCH RELEASE BEARINGS

1.4 Petrol
2.0 Petrol
Diesel, All models

UTJ100100
UTJ100170
UTJ100170

COOLING

ROVER 200 / 400 (1992-1996)

RADIATORS

1.6 Petrol, manual
1.6 Petrol, auto.
2.0 Petrol, air-con - exc: Turbo
2.0 Petrol Turbo

PCC001090EVA
PCC001088EVA
PCC10314EVA
PCC103930EVA

THERMOSTATS

1.4 Petrol, all models
1.6 Petrol - DOHC
1.6 Petrol - SOHC
2.0 Petrol - exc: air-con only
2.0 Petrol, air-con
Diesel, all models

PEL10016
FDU1762EVA
PEL10018EVA
13H7604
PEL10017
PEL100300EVA

WATER PUMPS

1.4 Petrol 8V
1.4 Petrol 16V
1.6 Petrol
1.7 Diesel, up to eng. 4016153
1.7 Diesel, from eng. 4016154
1.9 Diesel, up to eng. 4014119
1.9 Diesel, from eng. 4014120
2.0 Petrol

PEB000080SLP
PEB10051
PEB10139SLP
PEB10031EVA
PEB101780SLP
PEB10031EVA
PEB101780SLP
PEB102420L

ELECTRICAL

ROVER 200 / 400 (1992-1996)

BATTERIES

1.4/1.6 Petrol, Temperate climate
1.4/1.6 Petrol, Cold climate
1.7 Diesel
1.9 Diesel

GBY063
ZUA000063E
ZUA000027E
ZUA000027E

ENGINE SENSORS

Sensor - Oxygen multi point insection
2.0 Petrol exc Turbo

MHK10006



PRICES
SEE PAGES 124-151
OR VISIT OUR
WEBSITE

ROVER 200 / 400 (1992 - 1996)



EXHAUST SYSTEMS

ROVER 200 / 400 (1992-1996)

DOWNPIPES

1.4 Petrol 8V
1.4 Petrol 16V
1.6 Petrol - DOHC
1.6 Petrol - SOHC
1.7 Diesel
1.9 Diesel
2.0 Petrol - exc: Turbo
2.0 Petrol Turbo

WCD10229EVA
WCD10227EVA
WCD011097EVA
EFP6111EVA
WCD10034EVA
WCD10033EVA
WCD102730EVA
WCD10197EVA

CATALYTIC CONVERTERS

1.4 Petrol - exc: Germany
1.6 Petrol
2.0 Petrol exc. Turbo - germany
2.0 Petrol Turbo - exc: Germany

WAG103100SLP
WAG103700
WAG10171EVAP
WAG008034EVA

INTERMEDIATES

1.4 Petrol 8V
1.4 Petrol 16V, up to BD34148
1.4 Petrol 16V, from BD34149
1.6 Petrol, closed loop-Cat 1 - SOHC
1.6 Petrol, closed loop-Cat 1 - DOHC
1.9 Diesel
2.0 Petrol - leaded, rear
2.0 Petrol - exc: Turbo
2.0 Petrol Turbo

WCE10182EVA
WCE10175EVA
WCE10182EVA
WCE102390EVA
WCE102400EVA
WCE10006EVA
WCE10126EVA
WCE10126EVA
WCE10178EVA

REAR ASSEMBLIES

1.4 Petrol 8V
1.4 Petrol 16V - exc: 4 door
1.4 Petrol 16V, 4 door
1.6 Petrol, 2/3/5 door/convertible - DOHC
1.6 Petrol, 4 door - DOHC
1.6 Petrol, 2/3/5 door - SOHC
1.6 Petrol, 4 door - SOHC
1.9 Diesel - 4 door
1.9 Diesel - 5 door
2.0 Petrol - leaded - exc: 4 door-Turbo
2.0 Petrol - leaded, 4 door - exc: Turbo
2.0 Petrol Turbo - exc: 4 door

WCG101890EVA
WCG101890EVA
WCG101900EVA
WCG10222EVA
WCG101480EVA
EGP1617EVA
WCG101460EVA
WCG101900EVA
WCG101890EVA
WCG10120EVA
WCG033546EVA
WCG10108EVA

LIGHTING

ROVER 200 / 400 (1992-1996)

HEADLAMPS

RHD vehicles All models,
RH - exc: Japan
LH - exc: Japan
RH, Japan
LH, Japan

XBC103020
XBC103030P
XBC103140
XBC103150

LHD vehicles All models,

RH, up to AD646083 -
exc: France, Germany
RH, up to AD646083, France
LH, up to AD646083 -
exc: France, Germany
LH, up to AD646083, France
RH, from AD646084 - exc: Germany
LH, from AD646064 - exc: Germany
RH, Germany
LH, Germany

XBC103040
XBC103040
XBC103050
XBC103050
XBC103040
XBC103050
XBC103080
XBC103090

INDICATOR LAMPS All models,

RH
LH

XBD10060
XBD10061

REAR LAMPS All models,

RH, direction indicator - Grey
LH, direction indicator - Grey

XFB10074
XFB10075

HEADLAMP BULBS

Main & dipped front light,
h4-60/65 Watt - Clear
Main beam, h1-55 Watt
Capless side lamp -
Bulb-501, w10/5-5 Watt

XZQ000150
GLB448
AFU4481

INDICATOR LAMP

Bulbs Clear - Bulb-382, 21 Watt

GLB382

REAR LAMP BULBS

Clear - Bulb-382, 21Watt
Yellow, direction indicator -
Bulb-344, 21 Watt

GLB382
XZQ100190L

Capless, clear - Bulb-501, w10/5-5 Watt

AFU4481

CLEAR SIDE REPEATER LAMP CONVERSION KIT

Includes 2 Clear Side repeater lamps & 2 Amber Bulbs
All Models

RP1042

STEERING & SUSPENSION

ROVER 200 / 400 (1992-1996)

TRACK CONTROL ARM All models,

RH (Fit in Pairs)
LH (Fit in Pairs)

RBJ100781
RBJ100791

TRACK CONTROL ARM BUSH All models, RH & LH

EGP1673
EGP1662

ANTI ROLL BAR LINK All models, RH & LH

DRIVE SHAFT GAITER KIT

inner

1.4 Petrol
1.6 Petrol
2.0 Petrol
Diesel, All models

EJP1509
TDR10005EVA
TDR000230
TDR000230

outer

1.4 Petrol
1.6 Petrol
2.0 Petrol
Diesel, All models

TDR000140
TDR10004EVA
BAU5441
BAU5441

SHOCK ABSORBERS

front

1.4 (214SLi) Saloon - RH
1.4 (214SLi) Saloon - LH
1.4 Convertible - RH
1.4 Convertible - LH
1.6 Petrol, Tourer/Convertible - RH
1.6 Petrol, Tourer/Convertible - LH
1.6 (216GTi) - RH
1.6 (216GTi) - LH
2.0 Petrol Tourer - RH
2.0 Petrol Tourer - LH
Coupe, Petrol, manual - RH
Coupe, Petrol, manual - LH
2.0 (420GSi) Saloon - RH
2.0 (420GSi) Saloon - LH
2.0 (420SLi) Saloon - RH
2.0 (420SLi) Saloon - LH
Diesel - RH
Diesel - LH

RND10032EVA
RND10033EVA
RPD972076EVA
RND10129EVA
RND10032EVA
RND10033EVA
RND101980EVA
RND101990EVA
RPD972076EVA
RND10129EVA
RND101980EVA
RND101990EVA
RPD972076EVA
RND10129EVA
RPD972076EVA
RND10129EVA

rear

1.4 (414GSi), Saloon, 4 door
1.4 (214GSi), Saloon - exc: 2 door
1.6 Petrol - exc: Coupe, 216 Gti
1.6 (216GTi), Saloon - exc: 2 door
2.0 Petrol, Saloon -
420GSi/220GSi - exc: 2 door
Coupe, Petrol, 2 door
2.0 Petrol, Saloon - 420SLi, 4 door
2.0 Petrol, Tourer MPI
Diesel, All models

RPD10023EVA
RPD10023EVA
RPD10023EVA
RPD100680EVA

TRACK ROD ENDS All models

TRAILING ARM ASSEMBLY,

rear Drum brakes

RH
LH

RGG104040
RGG104050

rear Disc brakes,

RH
LH

RGG104060
RGG104070

WHEEL BEARING KIT

front All models

rear All models -exc: A.B.S.
rear 1.6 Petrol. A.B.S.

RFM000060
RLB000050
RLB001570EVA

COLLISION PARTS - FRONT

ROVER 200 / 400 (1992-1996)

BONNET

4 door, up to AD798419 - exc: 2.0
2.0, up to AD798419 - exc: 4 door
2.0, 4 door
3, 4 & 5 door, from AD798420 - exc: 2.0

BJA38067
BJA38042
BJA38068
BJA38067

FRONT BUMPER - 3 & 5 door

1.6 Petrol 216 GTi,
up to AD798419 - exc: front fog lamps
from AD798420 - exc: front fog lamps

DPB10044LML
DPB102460LML

1.6 Saloon 216 GTi,
up to AD78419, front fog lamps

DPB102470LML

2.0 Petrol 220 GTi,
up to AD798419 - exc: front fog lamps
from AD798420 - exc: front fog lamps

DPB102480LML
DPB102460LML

2.0 Petrol GTi,
up to AD798419, front fog lamps

DPB102470LML

2.0 Petrol 220 SLi,
from BD127065 - exc: front fog lamps

DPB102460LML

1.8 Diesel 218 D,
from BD127065 - exc: front fog lamps
from BD127065, front fog lamps

DPB102460LML
DPB102450LML

FRONT BUMPER - 4 door & Tourer

Petrol Saloon,
from AD605482 - exc: front fog lamps
2.0 Petrol Turbo, front fog lamps
Diesel, from AD605482 -
exc: turbo/front fog lamps

DPB102460LML
DPB102450LML

1.8 Turbo Diesel, up to AD759290 -
exc: front fog lamps

DPB102640LML
DPB102450LML

Diesel, from AD759291, front fog lamps

FRONT BUMPER - Cabriolet All models

from AD798420

DPB102460LML

FRONT PANELS All models

Front Panel Assembly
Headlamp mounting
RH
LH

ABH38008
ABH38009
ABG38009
ABC38005

Bonnet slam panel
Cross member, lower

FRONT WING All models,

RH
LH

ASB38030
ASB38031

GRILLE

Chrome
Painted, 2 door Coupe

DHB101920MMM
DHB10119

NOTES





ROVER 200 / 400 (1992 - 1996)

PRICES
SEE PAGES 124-151
OR VISIT OUR
WEBSITE



COLLISION PARTS - SIDE

ROVER 200 / 400 (1992-1996)

FRONT DOOR ASSEMBLY

3 Door Models From AD798420

RH

BDA381820

LH

BDA381830

Coupe, From AD798420

RH

BDA381880

LH

BDA381890

SKIN SILL 4 door

RH

RP1131

LH

RP1132

COLLISION PARTS - REAR

ROVER 200 / 400 (1992-1996)

REAR BUMPER - 3 & 5 door

1.4/1.6 Petrol saloon, 3 & 5 door,

up to AD798419 - exc: GTI

DQB10104LPL

1.6/2.0 Petrol saloon GTI, 3 door,

up to AD798419

DQB10040LML

1.8 Diesel, 5 door,

up to AD798419

DQB10094LPL

from AD798419 up to BD127064

DQB101910LPM

REAR BUMPER - 4 door & Tourer

Petrol, from AD471119 up to AD605481

Petrol, from AD605482

Diesel, from AD471119 up to AD605481

Diesel, from AD605482

DQB10117LML

DQB102030

DQB10118LML

DQB102020

AQA38002

REAR PANEL 2, 3 & 5 door

WFE10129P

FUEL TANK

Petrol models

Diesel models

WFE10179P

STYLING

ROVER 200 / 400 (1992-1996)

BOOT SPOILER 4 Door models

Quicksilver

Black

DFD10089MNS

DFD10089PMF



GREY FRONT MUD GUARDS -
CAS10040LOG

PROTECTION & STOWAGE

ROVER 200 / 400 (1992-1996)

MUD GUARDS All Models exc. Coupe

Black - Rear Pair

Grey - Front Pair

CAT100550PMD

CAS10040LOG



FRONT DOOR ASSEMBLY -
BDA381820

TOURING

ROVER 200 / 400 (1992-1996)

TOURING ESSENTIALS XTRA KIT

All models

XPT000138ACA

INTERIOR CARE XTRA KIT All models

XPT000139ACA

ESSENTIALS & INTERIOR CARE KIT All models

Includes XPT000138ACA & XPT000139ACA

RP1017

POWER SOURCE INVERTER - converts 12V DC into 240V AC

150 watt model

300 watt model

500 watt model

RX1551-150

RX1551-300

RX1551-500

LITERATURE

ROVER 200 / 400 (1992-1996)

HAYNES WORKSHOP MANUAL

214 & 414 models

216 & 416 models

RP1001

RP1002

HAYNES "MAN" MANUAL - 128 pages

Health Guide in style of Workshop Manual.

RX1534

HAYNES MANUAL PLASTIC PROTECTOR

RX1569

WHEELS & FITTINGS

ROVER 200 / 400 (1992-1996)

WHEEL CLEANING BRUSH (Fir Tree Shape)

KACB101

MWS WHEEL CLEANING KIT

RX1405

AUTOGLYM CLEAN WHEELS Alloy Wheel Cleaner

500ml

RX1322

AUTOGLYM ALLOY WHEEL SEAL 450ml

RX1443

RIMWAX Professional Wheel Polish and Sealer

RX1262

AUTOGLYM INSTANT TYRE DRESSING

RX1368

TYRE WELD Puncture Repair (Holts Brand)

300ml

GAC9903X-300ML

400ml

GAC9903X-400ML

DIGITAL TYRE PRESSURE GAUGE

XPT000006ACA

TYRE TREAD DEPTH GAUGE

27298

SAFETY

ROVER 200 / 400 (1992-1996)

FIRE EXTINGUISHER

600gm Red Alloy

Red, Powder, 1Kg

S3SSFE1

GAC9904X

PARKING AID UNIVERSAL KIT All models

Including 4 sensors and all fittings

RX1559

WARNING TRIANGLE Universal All Models

RX1344

SAFETY VEST (luminous)

GAC2999

NOTES



PRICES
SEE PAGES 124-151
OR VISIT OUR
WEBSITE

ROVER 200 COUPE / CABRIOLET, 400 TOURER

(1996-99)



SERVICE PARTS

ROVER 200 COUPE/CABRIOLET, 400 TOURER (1992-96)

AIR FILTERS

Petrol, All models
1.7 Diesel

PHE000121
PHE10004EVA

FUEL FILTERS

Petrol, All models
1.7 Diesel

WJN101191
WJN100650EVA

OIL FILTERS

Petrol, All models
1.7 Diesel

LPW100181
LRF10002EVA

POLLEN FILTERS

All models - exc: air-con

JKR100020

GLOW PLUGS

1.6 Petrol
1.8 Petrol

NCC10001

SPARK PLUGS

Blade-windscreen wiper,
RHD vehicles
LHD vehicles
Backlight Wiper - Coupe
Tailgate Wiper - Tourer

NLP000040
NLP100290

FUEL PUMPS

Petrol, All models
1.7 Diesel

DKC10002
DKC10003
DKC000045SLP
DKC000045SLP

TIMING BELTS

1.6 Petrol
1.8 Petrol, front
1.8 Petrol, rear
1.7 Diesel

WFX100631
MSR10014

TIMING BELT KIT (includes belt & tensioner)

1.6 (16V)
1.8 VVC

CDU2749
LHN100390
LHN100400
LHN10015EVA

ALTERNATOR BELTS

Petrol - exc: air-con
Petrol, air-con only
1.7 Diesel

RP1071
RP1079

DISTRIBUTOR CAPS

1.6 Petrol

PQS100840
PQS100940
PQS10043EVA

ROTOR ARMS

1.6 Petrol

NJD10010
NJE100070

BRAKING

ROVER 200 COUPE/CABRIOLET, 400 TOURER (1992-96)

BRAKE DISC

each
front Solid
front Vented
rear All models

SDB100500
SDB000990
EGP1254

BRAKE PADS (1 Set)

front Solid
front Vented
rear All models

SEB000290SLP
SFP000390
EJP1437

BRAKE SHOES

rear (1 Set) All models

SFS100090

BRAKE WHEEL CYLINDERS

rear All models

RH
LH

SML100080
SML100090

HANDBRAKE CABLES

Drum brakes, rear
RH
LH
Disc brakes, rear
RH
LH

SPB10010EVA
SPB10015EVA
SPB10011EVA
SPB10016EVA

ENGINE

ROVER 200 COUPE/CABRIOLET, 400 TOURER (1992-96)

CYLINDER HEAD BOLT

1.6/1.8 Petrol

WAM2293

HEAD GASKET SET

1.6 Petrol
1.8 Petrol (VVC)

LVQ000091SLP
LVQ000101SLP

CLUTCH

ROVER 200 COUPE/CABRIOLET, 400 TOURER (1992-96)

CLUTCH CABLES

RHD vehicles

1.6 Petrol
1.8 Petrol
1.7 Diesel

UUC101240
UUC10062EVA
UUC10052EVA

LHD vehicles

1.6 Petrol
1.8 Petrol
1.7 Diesel

UUC101250
UUC10049EVA
UUC10019EVA

CLUTCH KITS

1.6 Petrol, manual
1.8 Petrol
1.7 Diesel

URF000170
URF000121
URF009775EVA

CLUTCH COVERS

1.6 Petrol
1.8 Petrol
1.7 Diesel - Not Available Separately

URB10034
URB10009
See Clutch Kits

CLUTCH PLATES

1.6 Petrol, manual - Not Available Separately
1.6 Petrol, auto.
1.8 Petrol
1.7 Diesel

See Clutch Kits
UQB000060
UQB000221
UQB10017

CLUTCH RELEASE BEARINGS

1.6 Petrol
1.8 Petrol
1.7 Diesel

UTJ100100
UTJ100170
UTJ100170

COOLING

ROVER 200 COUPE/CABRIOLET, 400 TOURER (1992-96)

RADIATORS

Petrol, All models

PCC104671

AIR CON CONDENSER

All models

JRB100310SLP

THERMOSTATS

Petrol, All models
1.7 Diesel

PEL10016
PEL100300EVA

WATER PUMPS

Petrol, All models
1.7 Diesel

PEB10051SLP
PEB101780SLP

RIDGED COLLANT PIPE - Thermostat to bottom hose

1.6 petrol

PEP102160

ELECTRICAL

ROVER 200 COUPE/CABRIOLET, 400 TOURER (1992-96)

BATTERIES

1.6 Petrol

Temperate climate, up to WD929607
Temperate climate, from WD929608
Cold climate, up to WD929648
Cold climate, from WD929649

YGD100810
ZUA000063E
ZUA000063E
ZUA000027E
ZUA000027E
ZUA000027E

1.8 Petrol

1.7 Diesel

ENGINE SENSORS

Sensor - Oxygen multi point injection

1.6/1.8 petrol

MHK10006

EXHAUST SYSTEM

ROVER 200 COUPE/CABRIOLET, 400 TOURER (1992-96)

DOWNPIPES

1.6 Petrol, manual
1.6 Petrol, auto.
1.8 Petrol
1.7 Diesel

WCD104200
WCD104210
WCD104241
WCD10034EVA

CATALYTIC CONVERTERS

1.6 Petrol
1.8 Petrol

WAG103761SLP
WAG103650SLP

INTERMEDIATES

1.6 Petrol - exc: Japan
1.8 Petrol - exc: Japan

WCE103080EVA
WCE103400EVA

REAR ASSEMBLIES

1.6 Petrol - Tourer
1.6 Petrol - 2 Door Coupe/Convertible
1.8 Petrol - 2 Door Coupe
1.7 Diesel

WCG102380EVA
WCG102390EVA
WCG102510EVA
WCG10066EVA

LIGHTING

ROVER 200 COUPE/CABRIOLET, 400 TOURER (1992-96)

HEADLAMPS

RHD vehicles

All models,

RH, up to WD926117 - exc: Japan
LH, up to WD926117 - exc: Japan

XBC103020
XBC103030P
XBC103140
XBC103150

RH, Japan

LH, Japan

Headlamp levelling,

RH, from WD926118

XBC104640

LHD vehicles

All models,

RH, up to WD926117 - exc: Germany
LH, up to WD926117 - exc: Germany

XBC103040
XBC103050
XBC103080
XBC103090

RH, Germany

LH, Germany

Headlamp levelling,

RH, from WD926118 - exc: Germany

LH, from WD926118 - exc: Germany

XBC104660
XBC104670

INDICATOR LAMPS

All models

RH

LH

XBD10060
XBD10061

CLEAR SIDE REPEATER LAMP CONVERSION KIT

Includes 2 Clear Side Repeater lamps & 2 Amber Bulbs

All Models

RP1042

REAR LAMPS

All models,

RH

LH

XFB10074
XFB10075

HEADLAMP BULBS

Main & dipped front light,
h4-60/65 Watt - Clear

XZQ000150
GLB448

Main beam, h1-55 Watt

Capless side lamp -

Bulb-501, w10/5-5 Watt

AFU4481

INDICATOR LAMP BULBS

Clear, front - Bulb-382, p25/1-21 Watt

GLB382

REAR LAMP BULBS

Clear - Bulb-382, p25/1-21 Watt

GLB382

Yellow, direction indicator -

Bulb-344, 21 Watt

XZQ100190L

Capless, clear - Bulb-501, w10/5-5 Watt

AFU4481



ROVER 200 COUPE / CABRIOLET, 400 TOURER

(1996-99)

PRICES
SEE PAGES 124-151
OR VISIT OUR
WEBSITE



STEERING & SUSPENSION

ROVER 200 COUPE/CABRIOLET, 400 TOURER (1992-96)

TRACK CONTROL ARM All models

RH (Fit in Pairs)
LH (Fit in Pairs)

RBJ100781
RBJ100791

TRACK CONTROL ARM BUSH All models

RH & LH

EGP1673
EGP1662

ANTI ROLL BAR LINK All models, RH & LH

DRIVE SHAFT GAITER KIT
inner
1.6 Petrol, manual
1.6 auto./1.8 Petrol
1.7 Diesel

EJP1509
TDR000200
TDR000230

outer
Petrol, All models
1.7 Diesel

TDR000140
BAU5441

OUTER CV JOINT All Petrol models with ABS

SHOCK ABSORBERS

front
Petrol - Convertible/Tourer
Petrol - 2 Door Coupe

RND103440EVA
RND103450EVA

rear
Petrol - Convertible/Tourer
Diesel - Tourer

RPD10023EVA
RPD972323EVA

STEERING RACK GAITER KIT All models

TRACK ROD ENDS All models

TRAILING ARM ASSEMBLY, rear

Drum brakes,
RH
LH

RGG104040
RGG104050

Disc brakes,
RH
LH

RGG104060
RGG104070

WHEEL BEARING KIT,

front All models
rear All models - exc: A.B.S.
rear A.B.S., with disc rear brakes

RFM000060
RLB000050
RLB000060

COLLISION PARTS - FRONT

ROVER 200 COUPE/CABRIOLET, 400 TOURER (1992-96)

BONNET

Cabriolet/Tourer
Coupe

BKA38067
BKA38068

FRONT BUMPER

Cabriolet/Tourer, from AD798420
Coupe

DPB102460LML
DPB103060PMD

FRONT PANEL

Front panel assembly, All models
Bonnet slam panel
Bracket, centre stay
Cabriolet/Coupe

ABB380120
ABG38009

Tourer

ABU38090
ABU38050

Headlamp mounting, LH
Cross member, lower

ABH380210
ABC38005

FRONT WINGS All models,

RH
LH

ASB38030
ASB38031

GRILLE All models

DHB101920MMM

COLLISION PARTS - SIDE

ROVER 200 COUPE/CABRIOLET, 400 TOURER (1992-96)

FRONT DOOR ASSEMBLY - Coupe

RH
LH

BDA381880
BDA381890

COLLISION PARTS - REAR

ROVER 200 COUPE/CABRIOLET, 400 TOURER (1992-96)

REAR BUMPER

Coupe
Tourer, Primed (for painted options consult EPC)

DQB10088PMD

Petrol
Diesel

DQB102030
DQB102020

REAR PANEL

Cabriolet/Coupe
Tourer

AQA38002
AQA380230

TOURING

ROVER 200 COUPE/CABRIOLET, 400 TOURER (1992-96)

TOURING ESSENTIALS XTRA KIT

All models

XPT000138ACA

INTERIOR CARE XTRA KIT All models

XPT000139ACA

ESSENTIALS & INTERIOR CARE KIT All models

RP1017

Includes XPT000138ACA & XPT000139ACA

POWER SOURCE INVERTER - converts 12V DC into 240V AC

150 watt model
300 watt model
500 watt model

RX1551-150
RX1551-300
RX1551-500

TOWING ELECTRICS (13 pin European)

All models

RX1569

SAFETY

ROVER 200 COUPE/CABRIOLET, 400 TOURER (1992-96)

FIRE EXTINGUISHER

600gm Red Alloy
Red, Powder, 1Kg

S3SSFE1
GAC9904X

PARKING AID UNIVERSAL KIT All models

Including 4 sensors and all fittings

RX1559

WARNING TRIANGLE Universal All Models

RX1344

SAFETY VEST (luminous)

GAC2999

LITERATURE

ROVER 200 COUPE/CABRIOLET, 400 TOURER (1992-96)

OWNERS HANDBOOK

Tourer vin 312617 to vin 457575

RCL0256ENG

HAYNES "MAN" MANUAL - 128 pages,

Health Guide in style of Workshop Manual

RX1534

HAYNES MANUAL PLASTIC PROTECTOR

RX1569

WHEELS & FITTINGS

ROVER 200 COUPE/CABRIOLET, 400 TOURER (1992-96)

WHEEL CLEANING BRUSH (Fir Tree Shape)

KACB101

MWS WHEEL CLEANING KIT

RX1405

AUTOGLYM CLEAN WHEELS Alloy Wheel Cleaner

500ml

RX1322

AUTOGLYM ALLOY WHEEL SEAL 450ml

RX1443

RIMWAX Professional Wheel Polish and Sealer

RX1262

AUTOGLYM INSTANT TYRE DRESSING

RX1368

TYRE WELD Puncture Repair (Holts Brand)

300ml

GAC9903X-300ML

400ml

GAC9903X-400ML

DIGITAL TYRE PRESSURE GAUGE

XPT000006ACA

TYRE TREAD DEPTH GAUGE

27298



NOTES



PRICES
SEE PAGES 124-151
OR VISIT OUR
WEBSITE

ROVER 400 (1995 ON)



ROVER 400

SERVICE PARTS

ROVER 400 (1995 ON)

AIR FILTERS

Petrol, all models - exc: 1.6 Petrol, auto.
1.6 Petrol, auto.
2.0 Diesel

PHE100331
PHE100390
PHE100331

FUEL FILTERS

Petrol, All models - exc: 1.6 Petrol, auto.
1.6 Petrol, auto.
2.0 Diesel

WJN101191
WJN101050
WJN000130

OIL FILTERS

1.4 Petrol
1.6 Petrol - DOHC
1.6 Petrol - SOHC
2.0 Petrol
2.0 Diesel

LPW100181
LPW100181
LRF000020
ADU7417
ERR5542

CRANKSHAFT FRONT OIL SEAL

2.0 Petrol & Diesel

AHU2198

POLLEN FILTERS

All models, up to WD354434 - exc: air-con
All models, from XD354435 - exc: air-con
Air-con only - exc: 1.6 auto.
Air-con, 1.6 auto.

JKX100010
JKR100220
JKR100020
JKR100080

GLOW PLUGS 2.0 Diesel

NCC100050

SPARK PLUGS All models

NLP000040

WIPER BLADES

Blade-windscreen wiper,
driver's side
passenger's side

Blade-backlight wiper, 5 door

DKC100690
DKC100700
DKC100730

FUEL DELIVERY

In tank fuel pump & sender unit
1.4/1.6 Petrol manual/2.0 Petrol
1.6 Petrol, auto.

Fuel injection pump

Diesel, Tcie
Diesel, TCieM

WFX100631
WFX100961

ERR6381
ERR6380E

TIMING BELTS

1.4 Petrol
(8V)
(16V), 23mm wide,
up to eng. 646036/655216
(16V), 26mm wide,
from eng. 646037/655217

1.6 Petrol
DOHC, 23mm wide,
up to eng. 654922/655076
DOHC, 26mm wide,
from eng. 654923/655077

SOHC, up to eng. 299999 (D16Y3)
SOHC, from eng. 100001 (D16B2)
auto., from eng. 100001 (D16B2)

2.0 Petrol
2.0 Diesel - Front
2.0 Diesel - Rear

WAM2804
CDU2749

LHN100560
CDU2749

LHN100560
FDU1466
LHN100730
LHN100690

LHN10016
LHN10029
MVF10001

TIMING BELT KIT (includes belt & tensioner)

1.4 Petrol (8V)
1.4 Petrol (16V),
23mm wide, up to eng. 646036/655216
26mm wide, from eng. 646037/655217

1.6 Petrol - DOHC,
23mm wide, up to eng. 654922/655076
26mm wide, from eng. 654923/655077

1.6 Petrol - SOHC, up to eng. 299999 (D16Y3)*
2.0 Petrol

RP1070

RP1071
RP1078

RP1071
RP1078
RP1073
RP1080

ALTERNATOR BELTS

1.4/1.6 manual Petrol - exc: air-con
1.4/1.6 manual Petrol, air-con only
1.6 Petrol, auto.
2.0 Petrol - exc: air-con
2.0 Petrol, air-con only
2.0 Diesel - exc: air-con
2.0 Diesel, air-con only

PQS100840
PQS100940
PQS101080
PQS101590
PQS10035
PQS101030
PQS100851

DISTRIBUTOR CAPS

1.4/1.6 Petrol, manual
1.6 Petrol, auto.,
up to AD074464
from AD074465 up to AD250028
from WD250029

NJD10010
NJD100150
NJD100190
NJD100200

ROTOR ARMS

1.4/1.6 Petrol, manual
1.6 Petrol, auto.,
up to AD074464
from AD074465 up to AD250028
from WD250029

NJE100070SLP
NJE100060
NJ100030
NJE100100

BRAKING

ROVER 400 (1995 ON)

BRAKE DISC each

front Solid
front Vented
rear All models

SDB100500
SDB000990
EGP1254

BRAKE PADS (1 Set)

front Solid
front Vented
rear All models

SEB000290SLP
SFP000390
EJP1437

BRAKE WHEEL CYLINDERS, rear All models,

RH, up to AD74464
RH, from AD74465
LH, up to AD74464
LH, from AD74465

EJP1489
SML100080
EJP1488
SML100090
SFS100090

BRAKE SHOES, rear All models

HANDBRAKE CABLES

Disc brakes-rear,
RH
LH
Drum brakes-rear,
RH
LH

SPB000580
SPB000590
SPB100700
SPB000570

ENGINE

ROVER 400 (1995 ON)

CYLINDER LINER K Series Engine Models LCJ000050SLP

SEALANT FOR USE WHEN FITTING CYLINDER LINER

K series Engine Models

GGC102

CYLINDER HEAD STUD 1.4/1.6/1.8 Petrol WAM2293

SEAL-CAMSHAFT OIL -

Black, front 1.4-1.6-1.8 Petrol
Red, rear 1.4-1.6-1.8 Petrol
Front & Rear 2.0 Diesel

LUC100290SLP
LUC100220SLP
LZB100271

CAM COVER CASKET 1.4 Petrol (8V)

HEAD GASKET SET 2.0 Diesel Head Gasket not included due to variable Thickness

HEAD GASKET ONLY 2.0 Diesel

1.05MM.Thickness - 1 HOLE
1.20MM.Thickness - 2 HOLE
1.35MM.Thickness - 3 HOLE

LVP100390
LVQ101010
LVB100910
LVB100920
LVB100930
LVF100290

SUMP GASKET 1.4-1.6 Petrol

CLUTCH

ROVER 400 (1995 ON)

CLUTCH KITS

1.4/1.6 Petrol, manual
2.0 Petrol
2.0 Diesel, Tcie
2.0 Diesel, TCieM

URF000170
URF000121
URF000131
URF000060

CLUTCH COVER

1.4/1.6 Petrol, manual
2.0 Petrol
2.0 Diesel, Tcie

URB10034
URB10009
URB10035

CLUTCH PLATES

1.4/1.6 Petrol, manual,
up to eng. 133467/103723
1.6 Petrol, auto., up to eng. 299999 (D16Y3)
2.0 Petrol

UQB100720
TPB10001
UQB00221
UQB100692

CLUTCH RELEASE BEARINGS

1.4/1.6 Petrol, manual
2.0 Petrol
2.0 Diesel, Tcie
Diesel, All models

UTJ100100
UTJ100170
UTJ100170

COOLING

ROVER 400 (1995 ON)

RADIATORS

1.4/1.6 Petrol, manual,
large radiator - exc: air-con
air-con only

1.6 Petrol, auto.
2.0 Petrol
2.0 Diesel, Tcie
2.0 Diesel, TCieM

PCC001610SLP
PCC001610SLP
PCC105220
PCC001610SLP
PCC105500SLP
PCC105520

THERMOSTATS

1.4 Petrol
1.6 Petrol - DOHC
1.6 Petrol - SOHC
2.0 Petrol - exc: air-con
2.0 Petrol, air-con only

PEL10016
PEL10016
PEL100350
13H7604
PEL10017

WATER PUMPS

1.4 Petrol (8V)
1.4 (16V)
1.6 Petrol - DOHC
1.6 Petrol - SOHC,
manual, up to eng. 199999 (D16Y3)
auto., from eng.
200001 up to eng. 299999 (D16Y3)
100001 (D16B2)
2.0 Petrol
2.0 Diesel

PEB000080SLP
PEB102510SLP
PEB102510SLP
PEB10139SLP
PEB102300SLP
PEB102330SLP
PEB102420
PEB102420

RIDGED COOLANT PIPE - Thermostat to bottom hose

1.4/1.6/1.8 Petrol

PEP102160

ELECTRICAL

ROVER 400 (1995 ON)

BATTERIES

1.4/1.6 Petrol, manual,
up to WD318154 - cold climate
from WD318155

1.6 Petrol, auto., RHD vehicles
1.6 Petrol, auto., LHD vehicles
2.0 Petrol, up to WD325715
2.0 Petrol, from WD325716
2.0 Diesel

YGD100360
YGD100810
YGD100500
YGD100510
YGD100112
YGD100790
YGD100800

ENGINE SENSORS

Sensor - Oxygen multi point injection
Sensor - Crank

MHK10006
NSC100760

EXHAUST SYSTEM

ROVER 400 (1995 ON)

DOWNPIPES

1.4 Petrol (8V)
1.4 (16V)/1.6 manual Petrol
1.6 Petrol, auto.
2.0 Petrol
2.0 Diesel, manual

WCD105250
WCD104260
WCD103870
WCD104860
WCD104420

CATALYTIC CONVERTERS

1.4/1.6 manual Petrol
1.6 Petrol, auto. - exc: Japan
2.0 Petrol
2.0 Diesel, manual, up to XD413862
2.0 Diesel, manual, from XD413863

WAG103761SLP
WAG103700
WAG104070SLP
WAG103260SLP
WAG104790

INTERMEDIATES

1.4/1.6 manual Petrol
1.6 Petrol, auto.
2.0 Petrol
2.0 Diesel

WCE103340
WCE102450
WCE103180
WCE103250

REAR ASSEMBLIES

1.4/1.6 manual Petrol,
4 doors, up to AD250028
4 doors, from AD250029 (with finisher)
5 doors, up to AD250028
5 doors, from AD250029 (with finisher)
1.6 Petrol, auto., 4 doors
1.6 Petrol, auto., 5 doors
2.0 Petrol,
4 doors, up to AD 250028
4 doors, from WD 250029
5 doors, up to AD 250028
5 doors, from WD 250029
2.0 Diesel, 4 doors
2.0 Diesel, 5 doors

WCG102540
WCG102610
WCG102280
WCG102620
WCG102740
WDE100520
WCG102550
WCG102630
WCG102410
WCG102640
WCG102560SLP
WCG102430



ROVER 400 (1995 ON)

PRICES
SEE PAGES 124-151
OR VISIT OUR
WEBSITE



ROVER 400



HEADLAMP - XBC104390

LIGHTING

ROVER 400 (1995 ON)

HEADLAMPS

RHD vehicles

5 door, up to AD250028 - exc: headlamp levelling

RH XBC103440

LH XBC103450

4 door, up to AD250028 -exc: headlamp levelling

RH XBC103540

LH XBC103550

4 & 5 door, from WD250029 -exc: headlamp levelling

RH XBC103540

LH XBC103550

4 & 5 door, headlamp levelling, from WD250029

RH XBC104380

LH XBC104390

LHD vehicles

5 door - up to AD250028

RH XBC103420

LH XBC103430

4 door - up to AD250028

RH XBC103560

LH XBC103570

4 & 5 door, from WD250029

RH XBC103560

LH XBC103570

REAR LAMPS

4 door

RH XFB101000

LH XFB101010

5 door

RH, up to WD354434 XFB101040

RH, from XD354435 XFB101420

LH, up to WD354434 XFB101050

LH, from XD354435 XFB101430

HEADLAMP BULBS

Main beam, h1-55 Watt GLB448

H7, All models XZQ000210

Bulb-501, w10/5-5 Watt,

Clear - side repeater AFU4481

Bulb-382, p25/1-21 Watt -

Clear, direction indicator GLB382

Bulb-344 21 Watt -

Yellow, direction Indicator XZQ100190L

INDICATOR BULBS

Bulb-501-w10/5-5 Watt,

Clear- side repeater AFU4481

Bulb-wy5 Watt - Orange, side repeater XZQ100210L

REAR LAMP BULBS

Bulb-245-r19/10-10 Watt GLB245

Bulb-382-p25/1-21 Watt - Clear GLB382

Bulb-344 21 Watt -

Yellow, direction indicator XZQ100190L

Bulb-207-r19/55 Watt, rear fog GLB207

STEERING & SUSPENSION

ROVER 400 (1995 ON)

BALL JOINTS

1.4/1.6 Petrol - exc: A.B.S. RBK100350

2.0 Petrol RBK100380

DRIVE SHAFT GAITER KIT

inner

1.4/1.6 manual Petrol TDR000180

1.6 auto., Petrol, up to AD206263 TDR000160

2.0 Petrol/Diesel TDR100770

outer

1.4/1.6 manual Petrol TDR000190

1.6 auto., Petrol TDR000170

2.0 Petrol/Diesel TDR100760

CV JOINT - outer

1.4/1.6 manual, ABS TFB000100

1.4/1.6 manual, Exc ABS TFB000110

SHOCK ABSORBERS

front

1.4/1.6 manual Petrol, RH

1.4/1.6 manual Petrol, LH

1.6 auto., Petrol, RH

2.0 Petrol, RH

2.0 Petrol, LH

2.0 Diesel, RH

2.0 Diesel, LH

rear

1.4/1.6 manual Petrol

1.6 auto., Petrol

2.0 Petrol/Diesel

STEERING RACK GAITER KIT All models

TRACK ROD ENDS All models,

RH

LH

TRAILING ARM ASSEMBLY, rear

Drum Brakes

RH

LH

Disc Brakes

RH

LH

BUSH - Trailing Arm Assembly, rear

All models, RH & LH

WHEEL BEARING KIT,

front All models

rear

All models - exc: A.B.S.

A.B.S., with disc rear brakes - manual

A.B.S., with disc rear brakes - auto.

A.B.S., with drum rear brakes

COLLISION PARTS - FRONT

ROVER 400 (1995 ON)

BONNET All models

BKA140040

FRONT BUMPER All models,

4 door

DPC101331LML

5 door

DPC101520LML

FRONT PANEL

Front panel assembly exc: 1.6 auto.

Headlamp mounting RH

Bonnet slam panel

Bracket, centre stay

Cross member, lower

exc: 1.6 auto.

1.6 auto.

ABB140040

ABH140080

ABG140040

ABU140360

ABC140110

ABC140040

FRONT WING All models,

RH

LH

ASB140040

ASB140050

GRILLE All models

DHB101950MMM

COLLISION PARTS - REAR

ROVER 400 (1995 ON)

REAR BUMPER All models,

4 door

DQC101040LML

5 door

DQC101480LML

REAR PANEL ALL MODELS

AQA160010

PROTECTION & STOWAGE

ROVER 400 (1995 ON)

MUD GUARDS

Front Pair (exc. Where side sills are fitted)

4 & 5 Door Models

CAS100680LPU

Rear Pair 4 Door Models

CAT100750LPU

STYLING

ROVER 400 (1995 ON)

REAR DOOR SILL COVERS All models EBN100020MMM

TOURING

ROVER 400 (1995 ON)

TOURING ESSENTIALS XTRA KIT

All models

XPT000138ACA

INTERIOR CARE XTRA KIT All models

XPT000139ACA

ESSENTIALS & INTERIOR CARE KIT All models RP1017

Includes XPT000138ACA & XPT000139ACA

POWER SOURCE INVERTER - converts 12V DC into 240V AC

150 watt model

RX1551-150

300 watt model

RX1551-300

500 watt model

RX1551-500

SAFETY

ROVER 400 (1995 ON)

FIRE EXTINGUISHER

600gm Red Alloy

Red, Powder, 1Kg

S3SSFE1

GAC9904X

PARKING AID UNIVERSAL KIT All models

Including 4 sensors and all fittings

RX1559

WARNING TRIANGLE Universal All Models

RX1344

SAFETY VEST (luminous)

GAC2999

LITERATURE

ROVER 400 (1995 ON)

OWNERS HANDBOOKS All models

vin 192991 to vin 259651

RCL0199ENG

vin 259562 to vin 312616

RCL0216ENG

HAYNES WORKSHOP MANUAL

414 , 416 & 420 1995-1998

RP1005

HAYNES "MAN" MANUAL - 128 pages,

Health Guide in style of Workshop Manual

RX1534

HAYNES MANUAL PLASTIC PROTECTOR

RX1569

WHEELS & FITTINGS

ROVER 400 (1995 ON)

ALLOY WHEEL NUT non locking All models

up to AD175821

DBP7829

from AD175822

RRD100500

WHEEL CLEANING BRUSH (Fir Tree Shape)

KACB101

MWS WHEEL CLEANING KIT

RX1405

AUTOGLYM CLEAN WHEELS Alloy Wheel Cleaner

500ml

RX1322

AUTOGLYM ALLOY WHEEL SEAL 450ml

RX1443

RIMWAX Professional Wheel Polish and Sealer

RX1262

AUTOGLYM INSTANT TYRE DRESSING

RX1368

TYRE WELD Puncture Repair (Holts Brand)

300ml

GAC9903X-300ML

400ml

GAC9903X-400ML

DIGITAL TYRE PRESSURE GAUGE

XPT000006ACA

TYRE TREAD DEPTH GAUGE

27298

NOTES



PRICES
SEE PAGES 124-151
OR VISIT OUR
WEBSITE

ROVER 600 (1993 TO 1999)



ROVER 600

SERVICE PARTS

ROVER 600 (1993 TO 1999)

AIR FILTERS

Petrol, All models - exc: 2.0 Turbo
2.0 Petrol Turbo
2.0 Diesel

PHE100240EVA
PHE100331
PHE100331

FUEL FILTERS

Petrol, RHD vehicles,
up to AM246796 - exc: 2.0 Turbo
Petrol, LHD vehicles,
up to AM246796 - exc: 2.0 Turbo
Petrol, all models,
from BM246797 - exc: 2.0 Turbo
2.0 Petrol Turbo
2.0 Diesel

WJN100720P
WJN100710EVA
WJN101580EVA
WJN101520EVA
WJN000310

OIL FILTERS

Petrol, All models - exc: 2.0 Turbo
2.0 Petrol Turbo
2.0 Diesel

LRFO00020
ADU9826EVA
ERR5542

CRANKSHAFT FRONT OIL SEAL

2.0 Petrol & Diesel

AHU2198
NCC100050L

GLOW PLUGS 2.0 Diesel

SPARK PLUGS

Petrol, All models - exc: 2.0 Turbo
2.0 Petrol Turbo

NLP000050
NLP000040

WIPER BLADES Blade-windscreen wiper,
driver
passenger

DKC000555EVA
DKC000051EVA

FUEL DELIVERY

In tank fuel pump & sender unit
Petrol, all models,
up to AM246796 - exc: 2.0 Turbo
from BM246797 - exc: 2.0 Turbo
2.0 Petrol Turbo
Fuel injection pump
2.0 Diesel, up to AM246796
2.0 Diesel, from BM246797

WHG100030
WFX100760
WFX100800
MSR100200
ERR6381

BALANCE SHAFT DRIVE BELT

1.8, 2.0 & 2.30 Petrol - exc: Turbo

LIB100000EVA

TIMING BELTS

1.8/2.0 Petrol - exc: 2.0 Turbo
2.0 Petrol Turbo
2.0 Diesel, front
2.0 Diesel, rear
2.3 Petrol

LHN100370EVA
LHN10016
LHN10029
MVF10001
LHN100320EVA

TIMING BELT KIT (includes belt & tensioner)

2.0 Petrol Turbo
2.3 Petrol

RP1080
RP1075

ALTERNATOR BELTS

1.8 Petrol
2.0 Petrol - exc: 2.0 Turbo
2.0 Petrol Turbo - exc: air-con
2.0 Petrol Turbo, air-con only
2.0 Diesel - exc: air-con
2.0 Diesel, air-con only
2.3 Petrol, up to AM144844
2.3 Petrol, from AM144845

PQS101160EVA
PQS101160EVA
PQS101590
PQS10035
PQS101030
PQS100850
PQS000403EVA
PQS101160EVA

DISTRIBUTOR CAPS

1.8 Petrol, up to AM246796
All models, from BM246797 -
exc: 2.0 Turbo/2.3
2.0 Petrol Turbo
2.3 Petrol

NJD000405EVA
NJD100190
NJD10010
NJD000405EVA

ROTOR ARMS

1.8 Petrol, up to AM246796
All models, from BM246797 -
exc: 2.0 Turbo/2.3
2.0 Petrol Turbo
2.3 Petrol

NJE100060
NJI100030
NJE100070
NJE100060

BRAKING

ROVER 600 (1993 TO 1999)

BRAKE DISC

front each
Petrol, manual - exc: 2.0 Turbo/2.3
Petrol, auto.
2.0 Petrol Turbo
2.0 Diesel
2.3 Petrol
rear each All models

SDB090836SLP
SDB100670SLP
SDB100670SLP
SDB090836SLP
SDB100670SLP
SDB100290SLP

BRAKE PADS

front (1 Set)
All models, for 260mm diameter disc
All models, for 282mm diameter disc
rear (1 Set) All models

SFP100210EVA
SFP100140EVA
SFP100220EVA

HANDBRAKE CABLES All models,

RH
LH

SPB100431EVA
SPB100441EVA

ENGINE

ROVER 600 (1993 TO 1999)

CAM SEAL (Front & Rear) 2.0 Diesel

LZB100271

HEAD GASKET SET

2.0 Diesel (Head Gasket not included)

URFO09539EVA

HEAD GASKET ONLY 2.0 Diesel

1.05mm thickness - 1 HOLE
1.20mm thickness - 2 HOLE
1.35mm thickness - 3 HOLE

LVB100910
LVB100920
LVB100930

CLUTCH

ROVER 600 (1993 TO 1999)

CLUTCH KITS

Petrol, All models - exc: 2.0 Turbo
2.0 Petrol Turbo
2.0 Diesel

URFO09539EVA
URFO00190
URFO00131

CLUTCH COVER 2.0 Diesel

URB10035

CLUTCH PLATES 2.0 Diesel

UQB100692

CLUTCH RELEASE BEARINGS

2.0 Petrol Turbo
2.0 Diesel

UTJ100170
UTJ100170

COOLING

ROVER 600 (1993 TO 1999)

RADIATORS

Petrol - exc: 2.0 Turbo/2.3
2.0 Petrol Turbo
2.0 Diesel
2.3 Petrol

PCC001077SLP
PCC104260SLP
PCC104260SLP
PCC001077SLP

THERMOSTATS

Petrol, All models - exc: 2.0 Turbo
2.0 Petrol Turbo - exc: air-con
2.0 Petrol Turbo, air-con only

PEL10018EVA
13H7604
PEL10017

WATER PUMPS

Petrol, All models - exc: 2.0 Turbo/2.3
2.0 Petrol Turbo
2.0 Diesel
2.3 Petrol

PEB101930SLP
PEB102420L
PEB102420L
PEB101710SLP

ELECTRICAL

ROVER 600 (1993 TO 1999)

BATTERIES

Petrol, all models,
up to AM192629 - exc: 2.0 Turbo
Petrol, all models,
RHD, from AM192630 - exc: 2.0 Turbo
LHD, from AM192630 - exc: 2.0 Turbo
2.0 Petrol Turbo,
up to WM338604 - exc: air-con
air-con only
2.0 Diesel

ZUA000063SP
ZUA000063SP
YGD100241B
ZUA000027E
ZUA000027E
ZUA000096E

EXHAUST SYSTEM

ROVER 600 (1993 TO 1999)

DOWNPIPES

1.8/2.0 Petrol, low compression,
up to AM246796 - exc: 2.0 Turbo
1.8 Petrol, manual, low compression,
from BM246797
2.0 Petrol, high compression,
up to AM246796 - exc: Turbo
3.0 Petrol, high compression,
from AM246797 - exc: Turbo
2.0 Petrol Turbo, up to AM246796
2.0 Petrol Turbo, from BM246797
2.0 Diesel, up to AM246796
2.0 Diesel, from BM246797
2.3 Petrol, auto., up to AM246796
2.3 Petrol, manual, up to AM246796

WCD102830EVA
WCD033672EVA
WCD102700EVA
GEX33673
WCD103330EVA
WCD103860EVA
WCD103750EVA
WCD103911EVA
2B823857
WCD102720EVA

CATALYTIC CONVERTERS

Petrol, All models -
exc: 2.0 Turbo/2.3/Japan
2.0 Petrol Turbo,
up to AM246796
from BM246797 - exc: Japan
2.3 Petrol exc. Turbo - Japan
2.0 Diesel

WAG008037EVA
WAG103310EVA
WAG103640EVA
GEX8036P
WAG103260SLP

INTERMEDIATES

Petrol, low compression,
up to AM246796 - exc: 2.0 Turbo
1.8 Petrol, low compression,
from BM246797
2.0 Petrol, high compression,
up to AM246796 - exc: 2.0 Turbo
2.0 Petrol, high compression,
from BM246797 - exc: 2.0 Turbo
2.0 Petrol Turbo, up to AM246796
2.0 Petrol Turbo, from BM246797
2.0 Diesel, up to AM246796
2.0 Diesel, from BM246797
2.3 Petrol, up to AM246796
2.3 Petrol, from BM246797

WCE102000EVA
WCE103320EVA
WCE102010EVA
WCE103330EVA
WCE102650EVA
WCE103362EVA
WCE102690EVA
WCE103352EVA
WCE102010EVA
WCE103330EVA

REAR ASSEMBLIES

Petrol, low compression - exc: 2.0 Turbo
2.0 Petrol, high compression -
exc: 2.0 Turbo
2.0 Petrol Turbo, up to AM246796
2.0 Petrol Turbo, from BM246797
2.0 Diesel, up to AM246796
2.0 Diesel, from BM246797
2.3 Petrol

WDE100200EVA
WDE100190EVA
WCG101910SLP
WCG102161EVA
WCG101850EVA
WCG102291EVA
WDE100180EVA

LIGHTING

ROVER 600 (1993 TO 1999)

HEADLAMPS

RHD
RH, up to AM246796
RH, to AM246796 - exc: Japan
LH, up to AM246796 - exc: Japan
LH, from BM246797 - exc: Japan
RH, Japan only
LH, Japan only
LHD
RH, all models
LH, all models

XBC103170P
XBC103170P
XBC103200
XBC103650
XBC103520
XBC103530
XBC103190
XBC103160

REAR LAMPS all models

RH
LH

XFB100920
XFB100930

HEADLAMP BULBS

Main beam, h1-55 Watt
Clear, side lamp
Bulb-501, w10/5-5 Watt
Yellow, direction indicator
Bulb-344, 21 Watt

GLB448
AFU4481
XZQ100190L

INDICATOR LAMP BULBS Clear, side repeater

Bulb-501, w10/5-5 Watt

AFU4481

REAR LAMP BULBS

Clear - Bulb-382, p25/1-21 Watt
Bulb-380, p25/2-21/5 Watt
Clear, Japan only - Bulb-501, w10/5-5 Watt,
from AM202737

GLB382
GLB380
AFU4481





ROVER 600 (1993 TO 1999)

PRICES
SEE PAGES 124-151
OR VISIT OUR
WEBSITE



STEERING & SUSPENSION

ROVER 600 (1993 TO 1999)

BALL JOINTS All models

Lower
Upper

RBK100200EVA
RP1076

TRACK CONTROL ARM All models,

RH
LH

RBJ100690
RBJ100720

DRIVE SHAFT GAITER KIT

inner

All models - exc: 2.0 Turbo
2.0 Petrol Turbo

TDR100500EVA
TDR100770

outer

All models - exc: 2.0 Turbo
2.0 Petrol Turbo, up to AM144844
2.0 Petrol Turbo, from BM144845

TDR000159EVA
TDR000159EVA
TDR000159EVA
TDJ100360SLP

OUTER CV JOINT All models with ABS

SHOCK ABSORBERS - front

Petrol, up to AM246796 - exc: 2.0 Turbo

RH
LH

RND101880EVA
RND101890EVA

Petrol, from BM246797 up to BM299503

RH
LH

- exc: 2.0 Turbo
RND103100EVA
RND103110EVA

Petrol, from WM299504 - exc: 2.0 Turbo

RH
LH

RNB102581EVA
RNB102591EVA

2.0 Petrol Turbo, up to AM246796

RH
LH

RNB101940EVA
RNB101950EVA

2.0 Petrol Turbo, from BM246797

RH
LH

RND102751EVA

2.0 Diesel, up to AM246796

RH
LH

RNB101940EVA
RNB101950EVA

2.0 Diesel, from BM246797

RH
LH

RNB102581EVA
RNB102591EVA

SHOCK ABSORBERS - rear

Petrol, all models,
up to AM246796 - exc: 2.0 Turbo
from BM246797 - exc: 2.0 Turbo
2.0 Petrol Turbo, up to AM246796
2.0 Petrol Turbo, from BM246797
2.0 Diesel, up to AM246796
2.0 Diesel, from BM246797

RPD100640EVA
RPD101480EVA
RPD101010EVA
RPD101601EVA
RPD101240EVA
RPD101401EVA

STEERING RACK GAITER KIT All models, up to AM246796

QEY10005EVA

TRACK ROD ENDS All models,

RH
LH

QGX100140EVA
QGX100150EVA

UPPER REAR ARM ASSEMBLY All models,

RH
LH

RBJ001088EVA
RBJ001087EVA

WHEEL BEARING KIT

front All models
rear

EDP7418EVA

All models - exc: A.B.S.

A.B.S.,

up to AM144844 - exc: 2.0 Turbo

from AM144845 - exc: 2.0 Turbo

A.B.S., 2.0 Turbo Petrol/2.0 Diesel,

up to AM246796

A.B.S., all models, from BM246797

RFM001483EVA

RFM001484EVA

CKP7058EVA

RLB001564EVA

CKP7058EVA

COLLISION PARTS - FRONT

ROVER 600 (1993 TO 1999)

BONNET All models

BKA130020

FRONT BUMPER All models

DPC101050LML

FRONT PANEL

Front panel assembly

Headlamp mounting,

RH

ABB130050

LH

ABH130030

Bonnet slam panel

Bracket, centre stay

Cross member, lower front

ABH130040

ABG130080

ABU130190

ABC130060

FRONT WING All models,

RH

LH

ASB100010

ASB100020

GRILLE Bright

DHB101770MMM

COLLISION PARTS - REAR

ROVER 600 (1993 TO 1999)

REAR BUMPER All models

DQC100940LML

REAR PANEL ASSEMBLY all models

AQA100010

FUEL TANK All Models

WFE105180

PROTECTION & STOWAGE

ROVER 600 (1993 TO 1999)

MUD GUARDS Rear Pair All models

CAT100920PMD

TOURING

ROVER 600 (1993 TO 1999)

TOURING ESSENTIALS XTRA KIT

All models

XPT000138ACA

INTERIOR CARE XTRA KIT All models

XPT000139ACA

ESSENTIALS & INTERIOR CARE KIT All models

RP1017

Includes XPT000138ACA & XPT000139ACA

POWER SOURCE INVERTER - converts 12V DC into 240V AC

150 watt model

RX1551-150

300 watt model

RX1551-300

500 watt model

RX1551-500

SAFETY

ROVER 600 (1993 TO 1999)

EXTERIOR TEMPERATURE WARNING KIT

All models

VUB100230

FIRE EXTINGUISHER

600gm Red Alloy

Red, Powder, 1Kg

S3SSFE1

GAC9904X

PARKING AID UNIVERSAL KIT All models

Including 4 sensors and all fittings

RX1559

WARNING TRIANGLE Universal All Models

RX1344

SAFETY VEST (luminous)

GAC2999

LITERATURE

ROVER 600 (1993 TO 1999)

HAYNES WORKSHOP MANUAL

618, 620 & 623 1993-1997

RP1006

HAYNES "MAN" MANUAL - 128 pages,

Health Guide in style of Workshop Manual

RX1534

HAYNES MANUAL PLASTIC PROTECTOR

RX1569

WHEELS & FITTINGS

ROVER 600 (1993 TO 1999)

ALLOY WHEEL NUT non locking All models

DBP7829

WHEEL CLEANING BRUSH (Fir Tree Shape)

KACB101

MWS WHEEL CLEANING KIT

RX1405

AUTOGLYM CLEAN WHEELS Alloy Wheel Cleaner

500ml

RX1322

AUTOGLYM ALLOY WHEEL SEAL 450ml

RX1443

RIMWAX Professional Wheel Polish and Sealer

RX1262

AUTOGLYM INSTANT TYRE DRESSING

RX1368

TYRE WELD Puncture Repair (Holts Brand)

300ml

GAC9903X-300ML

400ml

GAC9903X-400ML

DIGITAL TYRE PRESSURE GAUGE

XPT000006ACA

TYRE TREAD DEPTH GAUGE

27298

NOTES





PRICES
SEE PAGES 124-151
OR VISIT OUR
WEBSITE

ROVER 800 (OCT 1991 TO JAN 1996 VIN 230966)



ROVER 800

SERVICE PARTS

ROVER 800 (1991 TO 1996)

AIR FILTERS

2.0 Petrol - exc: 2.0 Turbo
2.0 Petrol Turbo
2.5 Diesel
2.7 Petrol

FUEL FILTERS

2.0 Petrol
2.5 Diesel
2.7 Petrol

OIL FILTERS

2.0 Petrol - exc: 2.0 Turbo
2.0 Petrol Turbo
2.5 Diesel
2.7 Petrol

GLOW PLUGS 2.5 Diesel

CRANKSHAFT FRONT OIL SEAL

2.0 Petrol & Diesel

SPARK PLUGS

2.0 Petrol
2.7 Petrol

WIPER BLADES

Blade-windscreen wiper,
driver, RHD & LHD vehicles
passenger, RHD vehicles,
up to AM110686/AM150297
from AM110687/AM150298
passenger, LHD vehicles,
up to AM112413/AM150789
from AM112414/AM150790

Blade-backlight wiper

FUEL DELIVERY

In tank fuel pump & sender unit
2.0 Petrol, normal aspiration
2.7 Petrol
Sender unit, 2.5 Diesel
Fuel lift pump, mechanical 2.5 Diesel,
Fuel injection pump, 2.5 Diesel

TIMING BELTS

2.0 Petrol
2.7 Petrol

TIMING BELT KIT (includes belt & tensioner)

2.0 Petrol

ALTERNATOR BELTS

2.0 Petrol - exc: air-con
2.0 Petrol, air-con only
2.5 Diesel - exc: air-con
2.5 Diesel, air-con only
2.7 Petrol

DISTRIBUTOR CAPS

2.0 Petrol
2.7 Petrol

ROTOR ARMS

2.0 Petrol
2.7 Petrol

BRAKING

ROVER 800 (1991 TO 1996)

BRAKE DISC

front each

2.0 Petrol - exc: 2.0 Petrol Turbo
2.0 Petrol Turbo, up to AM152056
2.0 Petrol Turbo, from AM152057
2.5 Diesel
2.7 Petrol, up to AM152056
2.7 Petrol, from AM152057

rear each All models

BRAKE PADS

front (1 Set)

2.0 Petrol - exc:
2.0 Petrol Turbo
2.0 Petrol Turbo, up to AM152056
2.0 Petrol Turbo, from AM152057
2.5 Diesel
2.7 Petrol, up to AM152056
2.7 Petrol, from AM152057

rear (1 Set) All models

HANDBRAKE CABLES All models,

RH
LH

PHE10021EVA
PHE000121
ASU1816SLP
XHM5384EVA

DCP9711EVA
ADU9779EVA
WFL100090EVA

ADU7417
ADU9826EVA
AEU2218EVA
EDU1082EVA
ADU9955

AHU2198

NLP000040
2N3132

DKC000048EVA

DKC000045SLP
DKC000048EVA

DKC000045SLP
DKC000048EVA
DKC000045SLP

WFX100780
WFX100910
WFX100580
WND100090
MSR100280

LHN10016
ECP244EVA

RP1080

PQS101590
PQS10045EVA
PQS051495EVA
PQS100950EVA
PQS10056EVA

NJD10010
NJD10004EVA

NJE100070
EDU1203EVA

SDB10026SLP
SDB090800EVA
SDB10026SLP
SDB10026SLP
SDB090800SLP
SDB10026SLP
SDB090802SLP

SFP100180EVA
SFP100190EVA
SFP100180EVA
SFP100180EVA
SFP100190EVA
SFP100180EVA
SFP000360

EMP7120EVA
EMP7537EVA

CLUTCH

ROVER 800 (1991 TO 1996)

CLUTCH KITS

2.0 Petrol - exc: 2.0 Petrol Turbo
2.0 Petrol Turbo, up to AM152419
2.0 Petrol Turbo, from AM152420
2.5 Diesel
2.7 Petrol

CLUTCH COVER

2.0 Petrol - exc: 2.0 Petrol Turbo

CLUTCH PLATES

2.0 Petrol - exc: 2.0 Petrol Turbo
2.0 Petrol Turbo, up to AM152419
2.0 Petrol Turbo, from AM152420

CLUTCH RELEASE BEARINGS

Petrol, All models - exc: 2.7

COOLING

ROVER 800 (1991 TO 1996)

RADIATORS

2.0 Petrol - exc: 2.0 Turbo
2.0 Petrol Turbo - exc: T series
2.5 Diesel
2.7 Petrol, manual
2.7 Petrol, auto.

THERMOSTATS

2.0 Petrol
2.7 Petrol

WATER PUMPS

2.0 Petrol
2.5 Diesel
2.7 Petrol

ELECTRICAL

ROVER 800 (1991 TO 1996)

BATTERIES

Petrol - exc: police vehicle
Diesel and police vehicle

ENGINE SENSORS

Sensor - Oxygen Multi Point Injection

URF000121
UQB10009EVA
URF000190
URF006605EVA
URF009978EVA

URB10009

UQB000221
UQB000221
UQB100750

UTJ100170

PCC10036EVA
PCC10079EVA
PCC10079EVA
PCC10036EVA
PCC10035EVA

13H7604

PEL10004EVA

PEB102420
PEB10080SLP
PEB102030SLP

ZUA000027E
ZUA000096E

MHK10006

EXHAUST SYSTEMS

ROVER 800 (1991 TO 1996)

DOWNPIPES

2.0 Petrol - exc: Turbo
2.0 Petrol Turbo (180 PS)
2.0 Petrol Turbo (200 PS)
2.5 Diesel
2.7 Petrol

CATALYTIC CONVERTERS

2.0 Petrol - exc: 2.0 Turbo/Germany
2.0 Petrol Turbo
(180 PS) - exc: Germany
(200 PS) - exc: Germany
2.7 Petrol

INTERMEDIATES

2.0 Petrol - exc: 2.0 Turbo/Japan
2.0 Petrol Turbo
(180PS), catalyst - exc: Japan
(200 PS)
2.5 Diesel
2.7 Petrol, unleaded - exc: Japan
2.7 Petrol, unleaded, Japan only

REAR ASSEMBLIES

2.0 Petrol - exc: 2.0 Turbo
2.0 Petrol Turbo (180 PS),
up to AM112751/AM151002
2.0 Petrol Turbo (200 PS)
2.5 Diesel
2.7 Petrol

WCD10136EVA
WCD10200EVA
WCD103160EVA
WCD10039EVA
WCD10216EVA

WAG10168EVA

WAG008031EVA
WAG103310EVA
WAG008023EVA

WCE10109EVA

WCE10154EVA
WCE102500EVA
EMP9109EVA
WCE10050EVA
WCE102070EVA

WCG10114EVA

WCG10016EVA
WCG101540EVA
WCG10016EVA
WCG10115EVA

LIGHTING

ROVER 800 (1991 TO 1996)

HEADLAMPS

RHD vehicles All models,
RH - exc: Japan
LH - exc: Japan
RH, Japan only
LH, Japan only

LHD vehicles All models,
RH
LH

INDICATOR LAMPS All models,

RH

LH

REAR LAMPS All models,

RH

LH

HEADLAMP BULBS

Capless, w/10/5-5 Watt -Clear
H3-55 Watt
H4-60/65 Watt - Clear

INDICATOR LAMP BULBS 21 Watt - Clear

REAR LAMP BULBS

21 Watt - Clear
55 Watt, rear fog

STEERING & SUSPENSION

ROVER 800 (1991 TO 1996)

BALL JOINTS All models,

upper
lower

ANTI ROLL BAR LINK All models, RH & LH

DRIVE SHAFT GAITER KIT All models

inner
outer

SHOCK ABSORBERS

front

2.0 Petrol, standard suspension
2.0 Petrol Turbo
(180 PS), sports suspension
(200 PS), Vitesse Sport
2.5 Diesel, standard suspension
2.7 Petrol, standard suspension

rear

All models, standard suspension,
RH - exc: self levelling
LH - exc: self levelling

All models, sports suspension,
RH - exc: self levelling
LH - exc: self levelling

All models, self levelling suspension,
RH

STEERING RACK GAITER KIT

2.0 Petrol - exc Turbo
2.5 Diesel
2.7 Petrol

TRACK ROD ENDS All models,

RH
LH

TRAILING ARM ASSEMBLY, rear All models,

RH

WHEEL BEARING KIT All models

front
rear RH
rear LH

XBC10278
XBC10279
XBC10284
XBC10285

XBC10280
XBC10281

XBD10056
XBD10057

XFJ10018
XFJ10019

AFU4481
AKF1786
XZQ000150

GLB382

GLB382
GLB207

ADU9549EVA
RKB10003EVA

EMP7331SLP

TDR000230
BAU5441

RNB10097EVA

RNB10106EVA
RND972500EVA
RNB10107EVA
RNB10097EVA

RPB10020EVA
RPB10021EVA

RPB10022EVA
RPB10023EVA

EDP3842EVA

BAU5722EVA
BAU5722EVA
BAU001120EVA

DCP7494EVA
DCP7495EVA

RGD10008

ADU9475EVA
ADU9665EVA
RFM001287EVA



ROVER 800 (OCT 1991 TO JAN 1996 VIN 230966)

PRICES
SEE PAGES 124-151
OR VISIT OUR
WEBSITE



COLLISION PARTS - FRONT

ROVER 800 (1991 TO 1996)

BONNET All models	BJA41012
FRONT BUMPER Painted Options listed on EPC All models - exc: Vitesse/Coupe	DPB10204PMD
GRILLE All models	DHB102360MAR
FRONT PANEL	
Headlamp mounting	
RH	ABH41012
LH	ABH41013
Bonnet slam panel, centre	ABG410030
Cross member, lower	ABC41007
FRONT WING All models, RH - exc: 2 door Coupe	ASB41024
RH, 2 door Coupe	ASB41030
LH, 2 door Coupe	ASB41031
FRONT DOOR ASSEMBLY	
RH - All Models exc. Coupe	BDA410440
LH - All Models exc. Coupe	BDA410450
RH - Coupe	BDA41036
LH - Coupe	BDA41037
FRONT DOOR SKIN	
RH - All Models exc. Coupe	BDA41010
LH - All Models exc. Coupe	BDA41011
RH - Coupe	BDA41018
LH - Coupe	BDA41019

TOURING

ROVER 800 (1991 TO 1996)

TOURING ESSENTIALS XTRA KIT All models	XPT000138ACA
INTERIOR CARE XTRA KIT All models	XPT000139ACA
ESSENTIALS & INTERIOR CARE KIT All models Includes XPT000138ACA & XPT000139ACA	RP1017
POWER SOURCE INVERTER - converts 12V DC into 240V AC	
150 watt model	RX1551-150
300 watt model	RX1551-300
500 watt model	RX1551-500

SAFETY

ROVER 800 (1991 TO 1996)

FIRE EXTINGUISHER 600 gm Red Alloy Red, Powder, 1Kg	S3SSFE1 GAC9904X
PARKING AID UNIVERSAL KIT All models Including 4 sensors and all fittings	RX1559
WARNING TRIANGLE Universal All Models	RX1344
SAFETY VEST (luminous)	GAC2999

LITERATURE

ROVER 800 (1991 TO 1996)

LITERATURE HAYNES WORKSHOP MANUAL 820, 825 & 827 1986-1995	RP1007
LITERATURE HAYNES "MAN" MANUAL - 128 pages, Health Guide in style of Workshop Manual	RX1534
HAYNES MANUAL PLASTIC PROTECTOR	RX1569

WHEELS & FITTINGS

ROVER 800 (1991 TO 1996)

WHEEL CLEANING BRUSH (Fir Tree Shape)	KACB101
MWS WHEEL CLEANING KIT	RX1405
AUTOGLYM CLEAN WHEELS Alloy Wheel Cleaner 500ml	RX1322
AUTOGLYM ALLOY WHEEL SEAL 450ml	RX1443
RIMWAX Professional Wheel Polish and Sealer	RX1262
AUTOGLYM INSTANT TYRE DRESSING	RX1368
TYRE WELD Puncture Repair (Holts Brand)	
300ml	GAC9903X-300ML
400ml	GAC9903X-400ML
TYRE TREAD DEPTH GAUGE	27298

COLLISION PARTS - REAR

ROVER 800 (1991 TO 1996)

REAR DOOR ASSEMBLY All Models exc. Coupe RH	BFA410300
LH	BFA410310
REAR DOOR SKIN All Models exc. Coupe RH	BFA410280
REAR BUMPER Painted Options listed on EPC All models - exc: Vitesse/Coupe	DQB10157PMD
REAR PANEL ASSEMBLY All models	AQA41003

NOTES



ROVER 800 (JAN 1996 VIN 230967 ON)

PRICES
SEE PAGES 124-151
OR VISIT OUR
WEBSITE



SERVICE PARTS

ROVER 800 (1996 ON)

AIR FILTERS	
2.0 Petrol - exc: 2.0 Turbo	PHE10021EVA
2.0 Petrol Turbo	PHE000121
2.5 Petrol	PHE100331
2.5 Diesel	ASU1816EVA
FUEL FILTERS All models	
Petrol	WJN101250EVA
Diesel	ADU9779EVA
OIL FILTERS	
2.0 Petrol - exc: 2.0 Turbo	ADU7417
2.0 Petrol Turbo	ADU9826EVA
2.5 Petrol	LRF000197EVA
2.5 Diesel	AEU2218EVA
GLOW PLUGS 2.5 Diesel	NCC100080
SPARK PLUGS Petrol, All models	NLP000040
WIPER BLADES	
Blade-windscreen wiper, RH & LH	DKC000048EVA
Blade-backlight wiper	DKC000045SLP
FUEL DELIVERY	
In tank fuel pump & sender unit, 2.5 Petrol	WFX100780
Sender unit, 2.5 Diesel	WFX100580
Fuel lift pump, mechanical, 2.5 Diesel	WND100090
Fuel injection pump, 2.5 Diesel	MSR100280
TIMING BELTS	
2.0 Petrol, All models	LHN10016
2.5 Petrol, front	LHN100410
2.5 Petrol, rear	LHN100420
TIMING BELT KIT (includes belt & tensioner)	
2.0 Petrol	RP1080
2.5 Petrol V6	RP1081

ALTERNATOR BELTS

2.0 Petrol - exc: air-con	PQS101590
2.0 Petrol, air-con only	PQS10045EVA
2.5 Petrol - exc: air-con	PQS101200EVA
2.5 Petrol, air-con only	PQS101210EVA
2.5 Diesel - exc: air-con	PQS051495EVA
2.5 Diesel, air-con only	PQS100950EVA

BRAKING

ROVER 800 (1996 ON)

BRAKE DISC All models front each	SDB10026SLP
rear each	SDB090802SLP
BRAKE PADS front (1 Set)	SFP100180EVA
rear (1 Set)	SFP000360
HANDBRAKE CABLES All models, RH	EMP7120EVA
LH	EMP7537EVA

ENGINE

ROVER 800 (1996 ON)

CYLINDER LINER 2.5 Petrol V6	LCJ000050SLP
SEALANT for use when fitting cylinder liner K Series Engine Models	GGC102
CYLINDER HEAD BOLT 2.5 Petrol V6	LDN10027

CLUTCH

ROVER 800 (1996 ON)

CLUTCH KITS	
2.0 Petrol - exc: 2.0 Turbo	URF000121
2.0 Petrol Turbo	URF000190
2.5 Petrol, manual	URF006518EVA
2.5 Diesel, manual	URF006605EVA
CLUTCH COVER	
2.0 Petrol - exc: 2.0 Turbo	URB10009
CLUTCH PLATES	
2.0 Petrol, manual - exc: 2.0 Turbo	UQB000221
2.5 Petrol, manual	UQB100772
CLUTCH RELEASE BEARINGS Petrol, All models	UTJ100170

COOLING

ROVER 800 (1996 ON)

RADIATORS 2.0/2.5 Petrol - exc: 2.0 Turbo	PCC104080SLP
THERMOSTATS	
2.0 Petrol, All models	13H7604
2.5 Petrol	PEM101050
WATER PUMPS	
2.0 Petrol, All models	PEB102420
2.5 Petrol	PEB101890EVA
2.5 Diesel	PEB10080SLP



PRICES
SEE PAGES 124-151
OR VISIT OUR
WEBSITE

ROVER 800 (JAN 1996 VIN 230967 ON)



ROVER 800

ELECTRICAL ROVER 800 (1996 ON)

BATTERIES

Petrol - exc: police vehicle
Diesel and police vehicle

YGD100790
YGD100800

EXHAUST SYSTEMS ROVER 800 (1996 ON)

DOWNPIPES

2.0 Petrol - exc: 2.0 Turbo
2.0 Petrol Turbo
2.5 Diesel

WCD103390EVA
WCD103400EVA
WCD103550EVA

CATALYTIC CONVERTERS

2.0/2.5 Petrol, unleaded, All models

WAG103640EVA

INTERMEDIATES

2.0 Petrol - exc: 2.0 Turbo
2.0 Petrol Turbo
2.5 Petrol
2.5 Diesel

WCE102702EVA
WCE102711EVA
WCE102931EVA
EMP9109EVA

REAR ASSEMBLIES

2.0 Petrol - exc: 2.0 Turbo
2.0 Petrol Turbo
2.5 Petrol
2.5 Diesel

WCG101942EVA
WCG102061EVA
WCG101971EVA
WCG101931EVA

LIGHTING ROVER 800 (1996 ON)

HEADLAMPS

RHD vehicles All models,
RH - exc: Headlamp levelling/Japan
LH - exc: Headlamp levelling/Japan
Japan, RH - exc: Headlamp levelling
Japan, LH - exc: Headlamp levelling
RHD vehicles Headlamp levelling,
RH, from WM251293 - exc: Japan
LH, from WM251293 - exc: Japan
LHD vehicles All models,
RH - exc: Headlamp levelling
LH - exc: Headlamp levelling
LHD vehicles Headlamp levelling,
RH, from WM251293
LH, from WM251293

XBC10278
XBC10279
XBC10284
XBC10285

XBC104720
XBC104730

XBC10280
XBC10281

XBC104740
XBC104750

INDICATOR LAMPS All models,

RH
LH

XBD10056
XBD10057

REAR LAMPS All models,

RH
LH

XFJ100380
XFJ100390

HEADLAMP BULBS

Capless side lamp - Bulb-501, w10/5-5 Watt
H3-55 Watt
H4-60/65 Watt - Clear

GLB501
AKF1786
XZQ000150

INDICATOR LAMP BULBS

Clear - Bulb-382, p25/1-21 Watt
Clear, side repeater - Bulb-501, w10/5-5 Watt

GLB382
GLB501

REAR LAMP BULBS

Yellow, direction indicator - Bulb-344, 21 Watt
Clear, stop lamp - Bulb-382, p25/1-21 Watt
Rear fog - Bulb-382, p25/1-21 Watt
Tail light - Bulb-207, r19/55 Watt
Stop lamp - Bulb-282, p25/1-21 Watt

XZQ100190L
GLB382
GLB382
GLB207
GLB382

STEERING & SUSPENSION ROVER 800 (1996 ON)

BALL JOINTS Lower front suspension

RKB10003EVA

DRIVE SHAFT GAITER KIT All models

inner
outer

TDR000230
BAU5441

SHOCK ABSORBERS, rear All models,

standard suspension
RH - exc: self levelling
LH - exc: self levelling
sports suspension,
RH - exc: self levelling
LH - exc: self levelling
self levelling suspension,
RH
LH

RPB100760EVA
RPB100750EVA

RPD101060EVA
RPD101070EVA

EDP3842EVA
EMP7423EVA

STEERING RACK GAITER KIT

All models - exc: 2.0 Turbo

BAU5722EVA

TRACK ROD ENDS All models,

RH
LH

DGP7494EVA
DGP7495EVA

TRAILING ARM ASSEMBLY, rear All models,

RH

RGD10008

WHEEL BEARING KIT All models,

front
rear RH
rear LH

ADU9475EVA
ADU9665EVA
RFM001287EVA

COLLISION PARTS ROVER 800 (1996 ON)

BONNET All models

BKA41012

LOWER WINDSCREEN FINISHER

2 door Coupe

DCB10056

FRONT BUMPER All models

DPB10204PMD

FRONT PANEL

Headlamp mounting
RH
LH

ABH41012
ABH41013
ABG410030
ABC41007

Bonnet slam panel, centre
Cross member, lower

FRONT WING All models,

RH - exc: 2 door Coupe
RH, 2 door Coupe
LH, 2 door Coupe

ASB41024
ASB41030
ASB41031

GRILLE All models

DHB102360MAR

REAR BUMPER All models

DQB10157PMD

REAR PANEL ASSEMBLY All models

FUEL TANK

AQA41003
WFE10211

PROTECTION & STOWAGE ROVER 800 (1996 ON)

MUD GUARDS - Rear Pair All Models

CAT10042MUD

RUBBER MATS - Front Pair (LHD)

EAH102270LNF

TOURING ROVER 800 (1996 ON)

TOURING ESSENTIALS XTRA KIT

All models

XPT000138ACA

INTERIOR CARE XTRA KIT All models

XPT000139ACA

ESSENTIALS & INTERIOR CARE KIT All models

RP1017

Includes XPT000138ACA & XPT000139ACA

POWER SOURCE INVERTER - converts 12V DC into 240V AC

150 watt model
300 watt model
500 watt model

RX1551-150
RX1551-300
RX1551-500

SAFETY ROVER 800 (1996 ON)

FIRE EXTINGUISHER

600 gm Red Alloy
Red, Powder, 1Kg

S3SSFE1
GAC9904X

PARKING AID UNIVERSAL KIT All models

Including 4 sensors and all fittings

RX1559

WARNING TRIANGLE Universal All Models

RX1344

SAFETY VEST (luminous)

GAC2999

LITERATURE ROVER 800 (1996 ON)

HAYNES "MAN" MANUAL - 128 pages, Health Guide in style of Workshop Manual

RX1534

WHEELS & FITTINGS ROVER 800 (1996 ON)

WHEEL CLEANING BRUSH (Fir Tree Shape)

KACB101

MWS WHEEL CLEANING KIT

RX1405

AUTOGLYM CLEAN WHEELS Alloy Wheel Cleaner

500ml

RX1322

AUTOGLYM ALLOY WHEEL SEAL 450ml

RX1443

RIMWAX Professional Wheel Polish and Sealer

RX1262

AUTOGLYM INSTANT TYRE DRESSING

RX1368

TYRE WELD Puncture Repair (Holts Brand)

300ml

GAC9903X-300ML

400ml

GAC9903X-400ML

DIGITAL TYRE PRESSURE GAUGE

XPT000006ACA

TYRE TREAD DEPTH GAUGE

27298

NOTES





ROVER P5 3.5 V8

PRICES
SEE PAGES 124-151
OR VISIT OUR
WEBSITE



SERVICE PARTS

ROVER P5 3.5 V8

OIL FILTER	RTC3186P
AIR FILTER	605191
PLUGS (8 required)	GSP4376
DISTRIBUTOR CAP	GDC117
ROTOR ARM	GRA112
CONTACT SET	GCS2117
CONDENSER	RTC3472P
COIL	GCL132
PLUG LEADS (SET)	GHT182S
FAN BELT	GCB11088

ENGINE PARTS

ROVER P5 3.5 V8

EXHAUST VALVE (8 required)	602165
INLET VALVE (8 required)	602166
OUTER VALVE SPRING (16 required)	602240A
INNER VALVE SPRING (16 required)	602241
VALVE GUIDE (16 required)	603554
SUMP PLUG	603659
SUMP PLUG WASHER	213961
DIPSTICK	60317P
DISTRIBUTOR DRIVE GEAR	605217P

COOLING

ROVER P5 3.5 V8

WATER PUMP	GWP310
FAN BELT	GCB11088
THERMOSTAT	GTS104
THERMOSTAT GASKET	GTG116

BREATHER SYSTEM

ROVER P5 3.5 V8

IN LINE FILTER	GFE7004
FLAME TRAP	603330

BRAKING

ROVER P5 3.5 V8

FRONT BRAKE HOSE	GBH124
------------------	--------

LIGHTING

ROVER P5 3.5 V8

HEADLIGHT (Sealed Beam)	GLU132
BACKING BOWL	S5400
HEADLAMP GASKET	9403

PROPSHAFT

ROVER P5 3.5 V8

UNIVERSAL JOINT (3 required)	RTC3346
------------------------------	---------

WASHER SYSTEM

ROVER P5 3.5 V8

PUMP & CAP	24G6271
BOTTLE	GWW904
BOTTLE BRACKET	570758
WASHER JET	GWW802
WIPER BLADE	GWB142

LITERATURE & MISC

ROVER P5 3.5 V8

FACTORY PARTS BOOK Rover P5 3 & 3.5 litre Saloon & Coupe	608264
FACTORY WORKSHOP MANUAL Rover P5 3 & 3.5 litre Saloon & Coupe	605358
OWNERS HANDBOOK Rover P5 3.5 litre Instruction manual	605214



ROVER P6 3.5 V8

PRICES
SEE PAGES 124-151
OR VISIT OUR
WEBSITE



SERVICE PARTS

ROVER P6 3.5 V8

OIL FILTER	RTC3186P
AIR FILTER	605191
PLUGS (8 required)	GSP4376
DISTRIBUTOR CAP	GDC117
ROTOR ARM	GRA112
CONTACT SET	GCS108
CONDENSER	RTC3472P
IGNITION COIL	GCL132
PLUG LEADS (SET)	GHT182S
SUMP PLUG WASHER	213961A

BREATHER SYSTEM

ROVER P6 3.5 V8

IN LINE FILTER	GFE7004
FLAME TRAP	603330
ENGINE PARTS	
EXHAUST VALVE (8 required)	602165
INLET VALVE (8 required)	602166A
OUTER VALVE SPRING (16 required)	602240A
INNER VALVE SPRING (16 required)	602241
VALVE GUIDE (16 required)	603554
DISTRIBUTOR DRIVE GEAR	605217P

ENGINE MOUNTINGS

ROVER P6 3.5 V8

FRONT MOUNTING	STC434P
----------------	---------

CLUTCH

ROVER P6 3.5 V8

SLAVE CYLINDER	514356
SLAVE CYLINDER REPAIR KIT	GRK4035

COOLING

ROVER P6 3.5 V8

WATER PUMP	GWP310
Non viscous	GWP317
Viscous type	
FAN BELT	
Non viscous	GCB11088
Viscous type	GCB11125
THERMOSTAT	GTS104
THERMOSTAT GASKET	GTG116

BRAKING SYSTEM

ROVER P6 3.5 V8

FRONT BRAKE HOSE	GBH166
REAR BRAKE HOSE	
RH	SHB000313EVAP
LH	GBH314P
SERVO NON RETURN VALVE	606030A

LIGHTING

ROVER P6 3.5 V8

HEADLIGHT	
Inner	GLU105
Outer	GLU135
BACKING BOWL & RIM	RS1114
HEADLAMP MESH GUARDS	RS1733

WASHER SYSTEM

ROVER P6 3.5 V8

WASHER BOTTLE	GWW904
CAP & PUMP	24G6271
WASHER BOTTLE BRACKET	570758
WIPER RACK	RTC202A
WIPER PARK SWITCH	520160A
WIPER BLADE	GWB197

SUSPENSION & STEERING

ROVER P6 3.5 V8

PROPSHAFT UNIVERSAL JOINT	TVC100010P
POWER STEERING PUMP	
Seal Kit	ABU7142
Gasket Kit	ABU7145
WHEEL BEARING	
Inner	UKC169
Outer	GHB102
INNER OIL SEAL	GHS114
REAR HUB OIL SEAL	GHS115

DOOR SEAL & LOCK

ROVER P6 3.5 V8

REAR DOOR LOCK MECHANISM	
LH	372360
RH	372361

LITERATURE & MISC

ROVER P6 3.5 V8

FACTORY PARTS BOOK Rover 2200 P6	RTC9011
Rover 3500 & 3500S P6	RTC9022/B
FACTORY WORKSHOP MANUAL Rover 3500 & 3500S P6	AKM3621
OWNERS HANDBOOK Rover 3500 & 3500S Series 2 P6	607875



PRICES
SEE PAGES 124-151
OR VISIT OUR
WEBSITE

MG MONTEGO 2.0 EFI & TURBO (1985 TO 1991)



SERVICE PARTS

MG MONTEGO 2.0 EFI (1985 TO 1991)

AIR FILTERS

All Models

EFI

Turbo, Up To 247734 Engine Code A32

Turbo, Up To 247734 Engine Code B63

Turbo, From 247735

DISTRIBUTOR CAP

All Models

ROTOR ARM

All Models

SPARK PLUG

EFI

HIGH TENSION LEAD SET

EFI

Turbo

IGNITION COIL

All Models

TIMING BELTS

Up To VIN 247734 -

Engine Codes A32,A50,A51 & B69

Engine Codes B55,B59,B60,B63 & B78

From VIN 247735 - All Models

TIMING BELT TENSIONER

Up To VIN 247734 -

Engine Codes B55,B59,B60,B63 & B78

From VIN 247735 - All Models

ALTERNATOR BELTS

Up To VIN 247734 -

Engine Codes A32,A50,A51 & B69

Engine Codes B55,B59,B60,B63 & B78

From VIN 247735 - All Models

ENGINE - BLOCK & FITTINGS

MG MONTEGO 2.0 EFI (1985 TO 1991)

OIL PUMP

EFI, Up To VIN 247734 -

Engine Codes A50,A51 & B69

Engine Codes B55,B59,B60 & B78

Turbo, Up To 247734

Engine Code B63

From VIN 247735 - All Models

BRAKING

MG MONTEGO 2.0 EFI (1985 TO 1991)

BRAKE DISC

front All Models

BRAKE PADS

front (1 Set) All Models

BRAKE SHOES

rear (1 Set) All Models

CLUTCH

MG MONTEGO 2.0 EFI (1985 TO 1991)

CLUTCH PLATES

All Models

CLUTCH COVER

All Models

CLUTCH RELEASE BEARINGS

All Models

27H2942EVA

ADU7417

LPW100181

ADU9826EVA

ADU9826EVA

NJD10010

AUU1690EVA

GSP6462

NGC000246EVA

NGC000247EVA

ADU6717EVA

CAM5231EVA

UAM1599EVA

UAM1599EVA

ADU8335

ADU8335

GCB10950

PQS040890EVA

PQS040890EVA

CAM5430

LPF000132EVAP

LPF000132EVAP

LPF000132EVAP

LPF000132EVAP

NAM7806

SFP10002EVA

CDU3022EVA

UQB000221

URB10009

UTJ100170

COOLING

MG MONTEGO 2.0 EFI (1985 TO 1991)

RADIATORS

EFI - exc: air-con

Turbo - exc: air-con

WATER PUMPS

EFI, Up To VIN 247734 -

Engine Codes A50,A51 & B69

Engine Codes B55,B59,B60 & B78

Turbo, Up To 247734

Engine Code A32

Engine Code B63

From VIN 247735 - All Models

PCC10006EVA

CDU1997

GWP155

PEB10002SLP

GWP156P

PEB10002SLP

PEB10002SLP

EXHAUST SYSTEM

MG MONTEGO 2.0 EFI (1985 TO 1991)

DOWNPIPES

EFI

Turbo

INTERMEDIATES

EFI, From VIN 355680

Turbo

REAR ASSEMBLIES

EFI

Turbo

WCD011013EVA

CRC7603EVA

WCE033225EVA

GEX33231P

CRC6732EVA

GEX33079P

STEERING & SUSPENSION

MG MONTEGO 2.0 EFI (1985 TO 1991)

FRONT STRUT

Up To VIN 593727

From VIN 593728

REAR STRUT

All Models

NAM4472EVA

RND972089EVA

NAM6691EVA

COLLISION PARTS

MG MONTEGO 2.0 EFI (1985 TO 1991)

FRONT DOOR

All Models

RH

LH

FRONT DOOR SKIN

All Models

RH

LH

REAR DOOR

All Models

RH

LH

REAR DOOR SKIN

All Models

LH

BOOT LID

All Models

BDA32004

BDA32005

BDA32010

BDA32011

BFA32002

BFA32003

BFA32017

CDP1141

NOTES

MG MONTEGO





MONTEGO DIESEL (NOV 1988 TO 1995)

PRICES
SEE PAGES 124-151
OR VISIT OUR
WEBSITE



SERVICE PARTS

MONTEGO DIESEL (NOV 1988 TO 1995)

AIR FILTERS 2.0 Diesel	ASU1816SLP
FUEL FILTERS All models	ADU9779EVA
OIL FILTERS All models	ERR5542
GLOW PLUGS All models	ADU9830
WIPER BLADES	
Windscreen-wiper	DKC000051EVA
Tailgate-wiper	DKC000045SLP
FUEL DELIVERY	
Fuel lift pump, mechanical, 2.0 Turbo Diesel	BDU2441
Fuel injection pump, 2.0 Turbo Diesel	BDU1588N
TIMING BELTS All models	ADU9878EVA
ALTERNATOR BELTS All models, use with pulley ADU8227 use with pulley PQR10008	ADU8798EVA 13H503EVA

BRAKING

MONTEGO DIESEL (NOV 1988 TO 1995)

BRAKE DISC , front each	
Solid	SDB090811SLP
Vented	NAM7806
BRAKE PADS , front (1 Set) All models, from 464731	SFP10002EVA
BRAKE SHOES , rear (1 Set) All models	CDU3022EVA
BRAKE WHEEL CYLINDERS	
Saloon, RH	SML901159EVA
Saloon, LH	SML901160EVA
Estate, RH	NAM4538EVA
Estate, LH	NAM4539EVA
HANDBRAKE CABLES	
Saloon/Estate, front	NAM4600EVA
Saloon, intermediate	NAM3607EVA
Estate, intermediate	NAM5604EVA
Saloon, rear	FAM8560EVA
Estate, rear	NAM5603EVA

ENGINE - OIL PUMP & FITTINGS

MONTEGO DIESEL (NOV 1988 TO 1995)

PUMP ASSEMBLY All models	LPF000130EVA
---------------------------------	--------------

CLUTCH

MONTEGO DIESEL (NOV 1988 TO 1995)

CLUTCH CABLES All models	UUC007067EVA
CLUTCH KIT All models	URF000121
CLUTCH COVER All models	URB10009
CLUTCH PLATES All models	UQB000221
CLUTCH RELEASE BEARINGS All models	UTJ100170

COOLING

MONTEGO DIESEL (NOV 1988 TO 1995)

RADIATORS All models - exc: air-con	PCC10006EVA
THERMOSTATS All models	PEL10002EVA
WATER PUMPS All models	PEB10041SLP

ELECTRICAL

MONTEGO DIESEL (NOV 1988 TO 1995)

BATTERIES All models	ZUA000096E
-----------------------------	------------

EXHAUST SYSTEM

MONTEGO DIESEL (NOV 1988 TO 1995)

DOWNPIPES All models	CRC7603EVA
INTERMEDIATES All models	CRC7614EVA
REAR ASSEMBLIES All models	CRC7789EVA

LIGHTING

MONTEGO DIESEL (NOV 1988 TO 1995)

HEADLAMPS	
RHD vehicles All models,	
RH	XBC10030
LH	XBC10031P
INDICATOR LAMPS All models,	
RH	LRC1164
LH	LRC1163
REAR LAMPS (lens and housing)	
Saloon, RH	XFJ10002
Saloon, LH	XFJ10003
Estate, RH	BAU5134
HEADLAMP BULBS	
Main bulb, h4-60/55w - Clear	XZQ000150
Capless, clear - Bulb-501, w10/5-5 Watt	AFU4481
INDICATOR LAMP BULBS	
Clear - Bulb-382, p25/1-21 Watt	GLB382
Capless, clear, side repeater - Bulb-501, w10/5-5 Watt	AFU4481
REAR LAMP BULBS	
Saloon	
stop/tail - Bulb-380, 21/5 Watt	GLB380
clear tail (behind reflex) - Bulb-501, w10/5-5 Watt	AFU4481
clear flasher/reverse/fog rearward - Bulb-382, p25/1-21 Watt	GLB382
Estate	
Bulb-380, 21/5 Watt	GLB380
clear - Bulb-382, p25/1-21 Watt	GLB382

STEERING & SUSPENSION

MONTEGO DIESEL (NOV 1988 TO 1995)

BALL JOINTS All models,	
RH	NAM7554EVA
LH	NAM7555EVA
SHOCK ABSORBERS	
front All models	RND972089EVA
rear Estate exc: self levelling suspension	NAM6691EVA
STEERING RACK GAITER KIT All models	BAU2361EVA
TRACK ROD ENDS All models	RBK000194EVA
WHEEL BEARING KIT	
front All models	RFM000050SLP
rear All models	88G520EVA

COLLISION PARTS - FRONT

MONTEGO DIESEL (NOV 1988 TO 1995)

BONNET All Models	BKA32002
FRONT DOOR All Models	
RH	BDA32004
LH	BDA32005
FRONT DOOR SKIN All Models	
RH	BDA32010
LH	BDA32011

COLLISION PARTS - REAR

MONTEGO DIESEL (NOV 1988 TO 1995)

REAR DOOR	
RH Saloon	BFA32002
LH Saloon	BFA32003
RH Estate	BFA32008
LH Estate	BFA32009
REAR DOOR SKIN All Models LH	BFA32017
BOOT LID Saloon	CDP1141
TAIL GATE ASSEMBLY Estate	CDP2302
REAR BUMPER Estate	CHM430

COLLISION PARTS - GLASS

MONTEGO DIESEL (NOV 1988 TO 1995)

WINDSCREEN Bronze Tint All Models From 560186	CMB10022
---	----------

TOURING

MONTEGO DIESEL (NOV 1988 TO 1995)

TOURING ESSENTIALS XTRA KIT All models	XPT000138ACA
INTERIOR CARE XTRA KIT All models	XPT000139ACA
ESSENTIALS & INTERIOR CARE KIT All models Includes XPT000138ACA & XPT000139ACA	RP1017
POWER SOURCE INVERTER - converts 12V DC into 240V AC	
150 watt model	RX1551-150
300 watt model	RX1551-300
500 watt model	RX1551-500

SAFETY

MONTEGO DIESEL (NOV 1988 TO 1995)

FIRE EXTINGUISHER	
600 gm Red Alloy	S3SSFE1
Red, Powder, 1Kg	GAC9904X
PARKING AID UNIVERSAL KIT All models Including 4 sensors and all fittings	RX1559
WARNING TRIANGLE Universal All Models	RX1344
SAFETY VEST (luminous)	GAC2999

LITERATURE

MONTEGO DIESEL (NOV 1988 TO 1995)

HAYNES WORKSHOP MANUAL	RP1126
HAYNES "MAN" MANUAL - 128 pages, Health Guide in style of Workshop Manual	RX1534
HAYNES MANUAL PLASTIC PROTECTOR	RX1569

WHEELS & FITTINGS

MONTEGO DIESEL (NOV 1988 TO 1995)

WHEEL CLEANING BRUSH (Fir Tree Shape)	KACB101
MWS WHEEL CLEANING KIT	RX1405
AUTOLYMB CLEAN WHEELS Alloy Wheel Cleaner 500ml	RX1322
AUTOLYMB ALLOY WHEEL SEAL 450ml	RX1443
RIMWAX Professional Wheel Polish and Sealer	RX1262
AUTOLYMB INSTANT TYRE DRESSING	RX1368
TYRE WELD Puncture Repair (Holts Brand)	
300ml	GAC9903X-300ML
400ml	GAC9903X-400ML
DIGITAL TYRE PRESSURE GAUGE	XPT000006ACA
TYRE TREAD DEPTH GAUGE	27298

NOTES



PRICES
SEE PAGES 124-151
OR VISIT OUR
WEBSITE

MG MAESTRO 2.0 EFI (1984 TO 1991)



MG MAESTRO

SERVICE PARTS

MG MAESTRO 2.0 EFI (1984 TO 1991)

AIR FILTERS All Models	27H2942EVA
OIL FILTERS All Models	ADU7417
DISTRIBUTOR CAP All Models	NJD10010
ROTOR ARM All Models	AUU1690EVA
SPARK PLUG All Models	GSP6462
HIGH TENSION LEAD SET All Models	NGC000246EVA
IGNITION COIL All Models	ADU6717EVA
TIMING BELTS	
Up To VIN 367394	
Engine Codes A50,A51 & B69	CAM5231EVA
Engine Codes B55 & B78	UAM1599EVA
From VIN 367395 - All Models	UAM1599EVA
TIMING BELT TENSIONER	
Up To VIN 367394	
Engine Codes B55 & B78	ADU8335
From VIN 367395 - All Models	ADU8335
ALTERNATOR BELTS	
Up To VIN 367394	
Engine Codes A50,A51 & B69	GCB10950
Engine Codes B55 & B78	PQS040890EVA
From VIN 367395 - All Models	PQS040890EVA

ENGINE - BLOCK & FITTINGS

MG MAESTRO 2.0 EFI (1984 TO 1991)

OIL PUMP	
Up To VIN 367394	
Engine Codes A50,A51 & B69	CAM5430
Engine Codes B55 & B78	LPF000132EVAP
From VIN 367395 - All Models	LPF000132EVAP

BRAKING

MG MAESTRO 2.0 EFI (1984 TO 1991)

BRAKE DISC front All Models	NAM7806
BRAKE PADS front (1 Set) All Models	SFP10002EVA
BRAKE SHOES rear (1 Set) All Models	CDU3022EVA

CLUTCH

MG MAESTRO 2.0 EFI (1984 TO 1991)

CLUTCH PLATES All Models	UQB000221
CLUTCH COVER All Models	URB10009
CLUTCH RELEASE BEARINGS All Models	UTJ100170

COOLING

MG MAESTRO 2.0 EFI (1984 TO 1991)

RADIATORS All Models - exc: air-con	PCC10006EVA
WATER PUMPS	
Up To VIN 367394	
Engine Codes A50,A51 & B69	GWP155
Engine Codes B55 & B78	PEB10002SLP
From VIN 367395 - All Models	PEB10002SLP

EXHAUST SYSTEM

MG MAESTRO 2.0 EFI (1984 TO 1991)

DOWNPIPES All Models	WGD011013EVA
INTERMEDIATES	
From VIN 270839 To VIN 358082	GEX33062P
REAR ASSEMBLIES	
From VIN 270839 To VIN 358082	GEX33063P

STEERING & SUSPENSION

MG MAESTRO 2.0 EFI (1984 TO 1991)

FRONT STRUT All Models	RND072530EVA
REAR STRUT All Models	NAM3959EVA
SPAX ADJUSTABLE SPRING SEAT UPATED	
FRONT STRUT All Models	RND072530EVA SPAX AS
SPAX ADJUSTABLE SPRING SEAT UPATED	
REAR STRUT All Models	NAM3959EVA SPAX AS

COLLISION PARTS

MG MAESTRO 2.0 EFI (1984 TO 1991)

FRONT BUMPER (Moulded) All Models	CHM431
REAR BUMPER (Moulded) All Models	CHM432
SILL All Model, RH	BEP2142
FRONT DOOR All Models	
RH	BDA31002
LH	BDA31003
REAR DOOR All Models	
RH	BFA31002
LH	BFA31003

NOTES

ORDER

BY PHONE: 01522 568000 / ON LINE: www.rimmerbros.co.uk / E-MAIL: mgrover@rimmerbros.co.uk



MAESTRO DIESEL (JAN 1986 TO 1995)

PRICES
SEE PAGES 124-151
OR VISIT OUR
WEBSITE



SERVICE PARTS

MAESTRO DIESEL (JAN 1986 TO 1995)

AIR FILTERS All models

FUEL FILTERS All models

OIL FILTERS All models

GLOW PLUGS All models

WIPER BLADES

Blade-windscreen wiper,
up to 400618
from 400619

Blade-tailgate wiper

FUEL DELIVERY

Fuel lift pump, mechanical,
2.0 Turbo Diesel Saloon

TIMING BELTS 2.0 Diesel

ALTERNATOR BELTS

2.0 Turbo Diesel, to eng. BA50206
2.0 Turbo Diesel, from eng. BA50353

ASU1816EVA

ADU9779EVA

ERR5542

ADU9830

DKC000051EVA

DKC000331EVA

DKC000051EVA

BDU2441

ADU9878EVA

GCB10914

13H503EVA

BRAKING

MAESTRO DIESEL (JAN 1986 TO 1995)

BRAKE DISC, front each Saloon

BRAKE PADS, front (1 Set) All models

BRAKE SHOES, rear (1 Set) Saloon

BRAKE WHEEL CYLINDERS

Saloon, RH

Saloon, LH

HANDBRAKE CABLES

Saloon, front

Saloon, intermediate

Saloon, rear

VAN, intermediate

VAN, rear

SDB090811SLP

SFP10002EVA

CDU3022EVA

SML901157EVA

FAM9359EVA

NAM3608EVA

NAM3607EVA

FAM8560EVA

SPB002631EVA

NAM4596EVA

CLUTCH

MAESTRO DIESEL (JAN 1986 TO 1995)

CLUTCH KIT All models

CLUTCH COVER All models

CLUTCH PLATES All models

CLUTCH RELEASE BEARINGS All models

URF000121

URB10009

UQB000221

UTJ100170

COOLING

MAESTRO DIESEL (JAN 1986 TO 1995)

RADIATORS All models

THERMOSTAT 2.0 Turbo Diesel

WATER PUMPS 2.0 Turbo Diesel,

Saloon, from eng. BA50353

VAN, from eng. BA50303

PCC10006EVA

PEL10002EVA

PEB10041SLP

PEB10041SLP



EXHAUST SYSTEMS

MAESTRO DIESEL (JAN 1986 TO 1995)

DOWNPIPES

Saloon -exc: Turbo

Saloon, Turbo

VAN, from 439586

INTERMEDIATES

Saloon -exc: Turbo

Saloon, Turbo

VAN, (+ rear assembly), from 14450

REAR ASSEMBLIES

Saloon -exc: Turbo

Saloon, Turbo

WCD011074EVA

CRC7603EVA

WCD011074EVA

WCO033460EVA

WCE033537EVA

CRC7785EVA

WCG033461EVA

WCG10111EVA

LIGHTING

MAESTRO DIESEL (JAN 1986 TO 1995)

HEADLAMPS LHD vehicles, Saloon, LH

INDICATOR LAMPS All models,

RH

LH

REAR LAMPS

Saloon, LH

VAN, RH

VAN, LH

HEADLAMP BULBS

Saloon, main bulb, h4-60/65 Watt

VAN, main bulb, up to 391939 - Bulb-410

VAN, main bulb, h4-60/65 Watt, from 391940

Saloon/VAN, pilot bulb - Bulb-233

INDICATOR LAMP BULBS

Clear, All models - Bulb-382, p25/1-21 Watt

Capless, clear, side repeater -

Bulb-501, w10/5-5 Watt

REAR LAMP BULBS

Saloon, stop/tail light - Bulb-380, 21/5 Watt

Saloon, capless clear tail light (behind reflex)

Bulb-501, w10/5-5 Watt

Saloon, clear (flasher/reverse/fog rearward)

Bulb-382, p25/1-21 Watt

VAN - Bulb-380, 21/5 Watt

VAN, clear - Bulb-382, p25/1-21 Watt

AFU4069

ADU6102

ADU6101

BAU2369

BAU5026

BAU5027

XZQ000150

OZQ000410EVA

XZQ000150

GLB233

GLB382

AFU4481

GLB380

AFU4481

GLB382

GLB380

GLB382

STEERING & SUSPENSION

MAESTRO DIESEL (JAN 1986 TO 1995)

BALL JOINTS All models

RH

LH

SHOCK ABSORBERS

front Saloon, from 637297

front VAN, up to 657410

rear Saloon,

from 367395 up to 610739

from 610740

rear VAN

STEERING RACK GAITER KIT All models

TRACK ROD ENDS All models

WHEEL BEARING KIT

front All models,

up to 378220

from 378221 up to 543486

from 543487

rear Saloon

rear VAN

NAM7554EVA

NAM7555EVA

NAM5120EVA

NAM7562EVA

RND072554EVA

NAM3959EVA

RPD10044EVA

BAU2361EVA

RBK000194EVA

ADU4600EVA

ADU9617EVA

RFM000050

88G520EVA

RFM001511EVA

COLLISION PARTS

MAESTRO DIESEL (JAN 1986 TO 1995)

FRONT BUMPER (Moulded) Saloon

REAR BUMPER (Moulded) Saloon

BONNET All Models

SILL Saloon

RH

LH

FRONT DOOR Saloon

RH

LH

REAR DOOR Saloon

RH

LH

CHM431

CHM432

BEP755

BEP2142

BEP2143

BDA31002

BDA31003

BFA31002

BFA31003

TOURING

MAESTRO DIESEL (JAN 1986 TO 1995)

TOURING ESSENTIALS XTRA KIT

All models

XPT000138ACA

INTERIOR CARE XTRA KIT All models

XPT000139ACA

ESSENTIALS & INTERIOR CARE KIT All models

Includes XPT000138ACA & XPT000139ACA

RP1017

POWER SOURCE INVERTER - converts 12V DC into 240V AC

150 watt model

300 watt model

500 watt model

RX1551-150

RX1551-300

RX1551-500

SAFETY

MAESTRO DIESEL (JAN 1986 TO 1995)

FIRE EXTINGUISHER

600 gm Red Alloy

Red, Powder, 1Kg

PARKING AID UNIVERSAL KIT All models

Including 4 sensors and all fittings

WARNING TRIANGLE Universal All Models

SAFETY VEST (luminous)

S3SSFE1

GAC9904X

RX1559

RX1344

GAC2999

LITERATURE

MAESTRO DIESEL (JAN 1986 TO 1995)

HAYNES WORKSHOP MANUAL

HAYNES "MAN" MANUAL - 128 pages,

Health Guide in style of Workshop Manual

HAYNES MANUAL PLASTIC PROTECTOR

RP1126

RX1534

RX1569

WHEELS & FITTINGS

MAESTRO DIESEL (JAN 1986 TO 1995)

WHEEL CLEANING BRUSH (Fir Tree Shape)

MWS WHEEL CLEANING KIT

AUTOGLYM CLEAN WHEELS Alloy Wheel Cleaner

500ml

AUTOGLYM ALLOY WHEEL SEAL 450ml

RIMWAX Professional Wheel Polish and Sealer

AUTOGLYM INSTANT TYRE DRESSING

TYRE WELD Puncture Repair (Holts Brand)

300ml

400ml

DIGITAL TYRE PRESSURE GAUGE

TYRE TREAD DEPTH GAUGE

KACB101

RX1405

RX1322

RX1443

RX1262

RX1368

GAC9903X-300ML

GAC9903X-400ML

XPT00006ACA

27298

NOTES



PRICES
SEE PAGES 124-151
OR VISIT OUR
WEBSITE

LUBRICANTS & FLUIDS

FLUIDS

EZL999 AUTOMATIC TRANSMISSION FLUID

for use in CVT and EM-CVT Gearbox 114, 216, Coupe, Cabriolet, Tourer, Rover 25,45, MG F, MG TF, MGZR, MG ZS

1 Litre **XPT0010020F**
20 Litres **XPT0010000F**

JF403E AUTOMATIC TRANSMISSION FLUID

for use in JF403E 4 speed and JF506E 5 speed Rover 825, 45, 75, MG ZT, MG ZT-T

5 Litres **VYK000040**

HONDAMATIC TRANSMISSION FLUID

96 ATF Rover 416, 618, 620 (not TI), 623

2.5 Litres **VDS000010**

MTF 94 MANUAL TRANSMISSION GEARBOX OIL

for use in PG1 and R380 gearbox Rover 218, 220D, 220Vi, 420, 420D, 620ti, 620D, 820, 825, Coupe, Cabriolet, Tourer, 25, 45, 75, Streetwise, MG F, MG TF, MG ZR, MG ZS, MG ZT, MG ZT-T

2.5 Litres **VYK000020**

BV75W-80 MANUAL TRANSMISSION GEARBOX OIL

for use in R65 Gearbox Rover 211, 214, 216, 414, 416, 620ti, 620D, 820, 825, Coupe, Cabriolet, Tourer, 25, 45 MG ZR

1 Litre **VYK000080**

BOT130M MANUAL TRANSMISSION GEARBOX OIL

for use in IB5 Gearbox Rover 25, 45, Streetwise, MG ZR

1 Litre **UGV000010**

75W/90 MANUAL TRANSMISSION GEARBOX OIL

1 Litre City Rover **UGV000020**

HYDROLASTIC SUSPENSION FLUID

5 litres Rover Mini, Metro, MG F **S3SHHF5**

PSFV POWER STEERING FLUID

for use when Honda PSF or PSFV fluid is specified
1 Litre All models with PAS **QVT000020**

DEXTRON II POWER STEERING FLUID

GUL355R



UNIVERSAL DOT 4 BRAKE AND CLUTCH FLUID

250ml All models **SIJ000010**
500ml All models **SIJ000020**
1 Litre All models **L3PFB401**
5 Litres All models **SIJ000040**
20 Litres All models **L3PFB420**

SILICON DOT 5 BRAKE AND CLUTCH FLUID

500ml All models **RX1327**
1 Litre All models **RX1326**



XPART OAT 5 YEAR LONGLIFE ANTIFREEZE

1 Litre All models **XP1LL**
5 Litres All models **XP5LL**
20 Litres All models **ZLA000020**

R134A AIR CONDITIONING FLUID

250ml All models with Aircon **JMF000020**

AIR CONDITIONING CLEANER AEROSOL

HALF PRICE **S3SGAC1**

SCREEN WASH

1 Litre All models **XP1SW**
2.5 Litres All models **XP25SW**
5 Litres All models **XP5SW**



MOTOR OILS

X-POWER 5W-30 PART SYNTHETIC

1 Litre Petrol engines, refer to Handbook **XP530PS1**
5 Litres Petrol engines, refer to Handbook **XP530PS5**

X-POWER 5W-40 FULLY SYNTHETIC

1 Litre Petrol engines, refer to Handbook **XP540FS1**
5 Litres Petrol engines, refer to Handbook **XP540FS5**

X-POWER 10W-40 PART SYNTHETIC

1 Litre Petrol engines, refer to Handbook **XP1040PS1**
5 Litres Petrol engines, refer to Handbook **XP1040PS5**

X-POWER 15W-40 MINERAL-PETROL

1 Litre Petrol engines, refer to Handbook **XP1540P1**
5 Litres Petrol engines, refer to Handbook **XP1540P5**

X-POWER 15W-40 MINERAL-DIESEL

1 Litre Diesel engines **XP1540D1**
5 Litres Diesel engines **XP1540D5**

OIL ABSORBENT GRANULES (for spillage)

30 Litres All models **GEM400**

CASTROL LOGO GREEN METAL CLASSIC OIL JUG

1/2 pint All models **RX1395**
1 pint All models **RX1396**
2 pint All models **RX1397**



SPECIALIST WHEEL CLEANER



MWS Wheel cleaner has been specially developed for use on Classic chromed and painted Wire, Steel and Alloy wheels. The cleaning system has a unique two stage process which not only cleans your wheels it also shines and protects them meaning they look good for longer and are easier to clean in the future.

The kit includes;

- Wheel Cleaning solution (580ml)
- A unique wooden handled wheel cleaning brush and dispenser
- Finish/Protect solution (180ml)
- Pair of disposable gloves

- Breaks down all brake-dust and road grime.
- Enables you to clean into all awkward places.
- Leaves wheels looking bright and clean.
- Protects wheels in the future.

WHEEL CLEANER KIT

RX1405



NOTES

GENERAL ACCESSORIES

PRICES
SEE PAGES 124-151
OR VISIT OUR
WEBSITE



GENERAL ACCESSORIES

HICLEAN HAND CLEANER

40g tube **RX1549T**
1.5g sachet **RX1549S**

HICLEAN LIQUID GLOVES 40g tube

RX1550T

POWER SOURCE INVERTER – converts 12V DC into 240V AC

150 watt model **RX1551-150**
300 watt model **RX1551-300**
500 watt model **RX1551-500**

SPARK PLUG SLEEVES All models

2 cylinder **RX1462SILVER**
2 cylinder **RX1462BLACK**
2 cylinder **RX1462RED**
2 cylinder **RX1462BLUE**
8 cylinder **RX1463SILVER**
8 cylinder **RX1463BLACK**
8 cylinder **RX1463RED**
8 cylinder **RX1463BLUE**

HT LEAD SLEEVES All models

2 cylinder **RX1464SILVER**
2 cylinder **RX1464BLACK**
2 cylinder **RX1464RED**
2 cylinder **RX1464BLUE**
8 cylinder **RX1465SILVER**
8 cylinder **RX1465BLACK**
8 cylinder **RX1465RED**
8 cylinder **RX1465BLUE**

SPARK PLUG SLEEVES & HT LEAD KIT All models

2 cylinder **RX1466SILVER**
2 cylinder **RX1466BLACK**
2 cylinder **RX1466RED**
2 cylinder **RX1466BLUE**
8 cylinder **RX1467SILVER**
8 cylinder **RX1467BLACK**
8 cylinder **RX1467RED**
8 cylinder **RX1467BLUE**

HI-TEMP SHRINK TUBES - 25 pack All models

18mm diameter **RX1468GREY**
18mm diameter **RX1468BLACK**
18mm diameter **RX1468RED**
18mm diameter **RX1468BLUE**
12 mm diameter **RX1469GREY**
12 mm diameter **RX1469BLACK**
12 mm diameter **RX1469RED**
12 mm diameter **RX1469BLUE**

THERMAL HEAT SLEEVE All models

fixed tube
0.5" x 3' **RX1471-50**
0.75" x 3' **RX1471-75**
1" x 3' **RX1471 1-0**
1.25" x 3' **RX1471 1-25**
1.5" x 3' **RX1471 1-5**
velcro tube 0.5"-1.5" x 3' **RX1472**

RADIATOR RELIEF COOLING SYSTEM ADDITIVE

473ml All models **RX1461-473**

COOL TAPE All models

1 3/8" x 15' **RX1474A**
1 3/8" x 30' **RX1474B**
2" x 60' **RX1474C**

HEAT & SOUND INSULATION MATERIAL All models

2' x 21" **RX1473A**
4' x 21" **RX1473B**
4' x 42" **RX1473C**

UNIVERSAL HEAT SHIELD 7" x 24" All models

RX1470

THERMO-TEC EXHAUST INSULATING WRAP

2" x 50' All models **RX1382**

Installation Strap Kit All models **RX1383**

EXHAUST PAINT AEROSOL

Black 400ml All models **RX1432A**

TURBO-GUARD UNIVERSAL TURBO LUBRICATION KIT

All models with turbocharger **RX1547**

TURBOCHARGER HEAT INSULATION KIT

All models with turbocharger **RX1546**

AIR INTAKE / INTERCOOLER PIPE HEAT PROOFING

VELCRO COVER 14" x 3' All models **RX1548**

RENOVO HOOD CARE PRODUCTS Convertible Models

VINYL TOP CLEANER 500ml **RX1529**

DRY CLEAN SHAMPOO for Canvas/Mohair 300ml **RX1530**

SOFT TOP REVIVER for Canvas/Mohair 500ml Black **RX1525BLACK**

500ml Blue **RX1525BLUE**

500ml Brown **RX1525BROWN**

1 Litre Black **RX1524BLACK**

1 Litre Blue **RX1524BLUE**

1 Litre Brown **RX1524BROWN**

ULTRA PROOFER

for Canvas/Mohair 500ml **RX1527**

1 Litre **RX1526**

for Vinyl 1 Litre **RX1528**

PLASTIC WINDOW POLISH

Removes scratches and discolouration 50ml **RX1531**

100ml **RX1532**

WD40

200ml Aerosol **GAC110**

400ml Aerosol **GAC111**

TYRE WELD Puncture Repair (Holts Brand)

300ml **GAC9903X-300ML**

400ml **GAC9903X-400ML**

RX1508

HOLTS RADWELD 250ml

RX1539-250ML

RX1539-500ML

HOLTS WONDERWELD

250ml **RX1511**

500ml **RX1511**

BRADEX EASY START 280ml

GHF6093

SILICON SEALANT 40ml Tube

GGC102

BLUE HYLOMAR GASKET SEALANT 100g tube

GCH112

EXHAUST JOINTING COMPOUND 250gm

RX1345

COPPER EASE GREASE 85gm tube

514578P

RUBBER GREASE 2oz

GBF901

BRAKE CLEANER 500ml Aerosol

GAC1003ML

LOCTITE THREAD LOCK

3ml **GAC10024ML**

24ml **GGL111**

LITHIUM GREASE 400gm tube

RX1353

TRIM ADHESIVE

1 Litre Tin **RX1353AEROSOL**

500ml Aerosol **RX1257**

SEAM SEALER Canvas Hoods

RX1373

FABSIL CANVAS WATERPROOFING DRESSING

Clear, 1 Litre **RX1406**

DISPOSABLE LATEX GLOVES 100 pack

RX1358

CAM LUBE 250ml Bottle

RX1534

HAYNES "MAN" MANUAL – 128 pages, Health Guide in style of Workshop Manual

RX1032

FINNEGANS WAXOYL PRODUCTS

STARTER KIT (2.5 Litre Can/Sprayer/Probe) **RX1027**

CAN 5 Litre **RX1028**

CARTRIDGE 2.5 Litre **RX1033**

SPRAY GUN **RX1030**

HIGH PRESSURE SPRAYER **RX1026**

AEROSOL 400ml **RX1025**

AEROSOL 200ml **RX1025**

UNDERBODY SEAL **RX1024**

1 Litre **RX1023**

500ml **RX1023**

AUTOGLYM CAR CARE PRODUCTS See page 65 for full details

AUTOGLYM CAR CARE PACK **RX1510**

includes items marked*

SILICONE RESIN POLISH (325ml)* **RX1312**

BODYWORK SHAMPOO/CON' D (500ml)* **RX1313**

CAR INTERIOR SHAMPOO (500ml)* **RX1314**

GLASS POLISH (325ml)* **RX1315**

CUTTING POLISH (325ml)* **RX1316**

ULTRA DEEP SHINE (500ml) **RX1558**

EXTRA GLOSS PROTECTION (325ml)* **RX1317**

BUMPER CARE (325ml)* **RX1318**

VINYL & RUBBER CARE (500ml)* **RX1319**

LEATHER CARE CREAM (325ml)* **RX1320**

SUPERGLYM CHROME POLISH (55g)* **RX1321**

CLEAN WHEELS (500ml)* **RX1322**

PERFECT POLISHING CLOTH (21sq ft)* **RX1323**

AQUA DRY (Synthetic Chamois)* **RX1324**

CLEAN MACHINE (1 Litre)* **RX1325**

HOOD CARE & MAINTENANCE KIT **RX1433**

INSTANT TYRE DRESSING **RX1368**

INTENSIVE TAR REMOVER **RX1367**

ALLOY WHEEL SEAL (450ml) Silicone spray. **RX1443**

SPONGE **RX1415**

WASH LEATHER **RX1416**

BASIC CAR CARE KIT **RX4079**

WASH'N'POLISH KIT **RX4080**

HOME VALET KIT **RX4081**

FINISHING TOUCHES KIT **RX4082**

INTERIOR CARE KIT **RX4083**

COSMETIC COLLECTION **RX1582**

CONCOURS COLLECTION **RX1583**

VALET COLLECTION **RX1584**

GLOSS BLACK AEROSOL 400ml **RX4070A**

MATT BLACK AEROSOL 500ml **RX1266**

SATIN BLACK AEROSOL 500ml **RX1538**

SILVER AEROSOL 450ml **RX1265**

CLEAR LACQUER AEROSOL 400ml **RX1261**

WHITE PRIMER AEROSOL 150ml **RX4048A**

RED OXIDE PRIMER 150ml **RX4049A**

GREY PRIMER AEROSOL 150ml **RX4047A**

HI-COTE PAINT (HIGH TEMPERATURE)

Black 400ml **RX1432A**

BLACK ENGINE PAINT (Brush On) 125ml **RX1432B**

GLOSS BLACK TOUCH UP 125ml **RX4070B**

TWIN AIR HORN KIT inc Compressor and fittings **RX1381 MARCO**

All models **RX1381 MARCO**

K&N AIR FILTER CLEANING FLUID 1 Litre **RX1346**

K&N AIR FILTER OIL

57cc Sachet **RX1347**

250ml Bottle **RX1348**

400ml Aerosol **RX1349**

WHEEL CHOCK (each) All models **ANR3052**

OIL FILTER REMOVAL STRAP WRENCH (1/2" Dive) **RX1514**

DRAPER REAR BRAKE CALIPER PISTON WIND BACK TOOL **RP1112**

BATTERY CONDITIONER KIT, CTEK800, (keeps battery charged during storage) **RX1410CTEK**

BATTERY CHARGER **GAC7106**

KEY FOBS

MG Octagon - Brown & Cream **RP1049**

MG Octagon - Black & White **RP1051**

MG Octagon - Red & Cream **RP1052**

Rover **R01067**

V8 **RX1537**

Union Jack **RX1545**

Rover (Viking Badge) **RP1158**

MG Round Fob **RP1159**

NOTES



Price GUIDE Price GUIDE Price GUIDE Price GUIDE

Use this section to check the price of the part number obtained from the Quickfinder catalogue listings sections on pages 68 to 123.

Note: We only show prices for parts listed in the Quickfinder. For a complete list of all MG Rover part numbers (600,000) and current prices, please visit our website, or contact us.

Please Note:- Prices correct at 1/8/10 and are subject to change without notice. Please confirm all prices when ordering. Up to date prices are available on our website.

099995MINI-2B290161SS

WEB ORDER - YOU SHOP - WE DELIVER. www.rimmerbros.co.uk

Part Number	Description	Price £ Ex VAT	Price £ Inc VAT
099995MINI	CATALYTIC CONVERTER	351.06	412.50
113087	WHEEL NUT (STEEL WHEEL)	1.36	1.60
11537512733	THERMOSTAT HOUSING	18.50	21.74
11537596787	THERMOSTAT - BMW MINI	20.00	23.50
11635296013	STUD ENQUIRE		
116227	GROMMET	1.44	1.69
11662	ROCKER SHAFT MGB	17.02	20.00
12-161	CRANKSHAFT LOCK WRENCH KV6	80.95	95.12
12-175	LOCKING TOOL	97.86	114.99
12102296026	THIN CASTLE NUT M16 X 1.5	0.44	0.52
121355	FRONT SIDELAMP ASSY	9.22	10.83
121356	FLASHER LAMP ASSY.	9.95	11.69
127916	NUMBER PLATE LAMP (CHROME)	18.02	21.17
127916 ORIG	REAR NO.PLATE LAMP "OE"(LUCAS)	23.65	27.79
12A1175EVA	GSKT RUB-TAPPET CVR.'A'SERIES ENG.S	2.18	2.56
12A1175EVA	GSKT RUB-TAPPET CVR.'A'SERIES ENG.S	0.85	1.00
12A1550EVA	HOSE-RADIATOR TO COOLANT PUMP	37.19	43.70
12A1550EVA	BOTTOM HOSE MINI	6.17	7.25
12A2075	ADAPTOR-PIPE	10.21	12.00
12A2178EVA	HOSE-COOLANT PUMP/EXPA/TANK/WATER	1.46	1.72
12A2178EVA	BYPASS HOSE & CLIPS	1.28	1.50
12A398P	LOCKTAB-CRANK MGB+MINI	0.55	0.65
12G1163EVA	HOSE-RADIATOR	3.58	4.21
12G1163EVA	TOP HOSE MINI 67>	2.72	3.20
12G1284SLP	PUMP-WATER	30.83	36.23
12G2373EVA	ELEMENT AIR CLEANER	4.35	5.11
12G2400EVA	USE 12G2400SLP		
12G2400SLP	FILTER OIL	1.71	2.01
12G2400SLP	OIL FILTER	1.50	1.76
12G2534	PIPE-OUTLET-HEATER	30.09	35.36
12G2621	TENSIONER-TIMING CHAIN	11.41	13.41
12G2621P	TENSIONER-TIMING CHAIN	4.42	5.19
12G290	RING GEAR 10988cc S-M	14.47	17.00
12G330EVA	THERMOSTAT GASKET	1.12	1.32
12G330EVA	THERMOSTAT GASKET A SERIES	0.25	0.29
12G3699EVA	ELEMENT AIR CLEANER	2.46	2.89
12G806EVA	ELEMENT AIR CLEANER	3.14	3.69
12G806EVA-K	KN N FILTER 998cc MINI	23.79	27.95
12H1018	GASKET-OIL PUMP	0.38	0.45
12H2521	PISTON SET(4)STD MGB'65-70	113.00	132.78
12H2521-020	PISTON SET(4)+020 MGB'65-70	113.00	132.78
12H2521-030	PISTON SET(4)+030 MGB'65-70	113.00	132.78
12H2521-040	PISTON SET(4)+040 MGB'65-70	113.00	132.78
12H2521-060	PISTON SET(4)+060 MGB'65-70	113.00	132.78
12H3165EVA	BELT	3.87	4.55
12H3273	HEAD-FILTER	75.00	88.13
12H3274EVA	FILTER OIL	2.40	2.82
12H3274EVA	FILTER OIL ENQUIRE		
12H3292	TENSIONER	6.70	7.87
12H3700EVA	GASKET-CAMSHAFT COVER	3.83	4.50
12H3700EVA	GASKET-CAMSHAFT CVR MGB	1.45	1.70
12H4211	INLET VALVE	3.65	4.29
12H5038	DISTRIBUTOR 45D4 MGB>74	69.79	82.00
12H797	HOUSING-THERMOSTAT MGB '63-67	15.11	17.75
12R208	VALVE TIMING TOOL	108.08	126.99
13150609326	SPLIT PIN	0.36	0.42
134174	SOLENOID (STARTER MOTOR)	9.55	11.22
134529	BRAKE LIGHT SWITCH	4.47	5.25
13621486698	SWITCH	6.50	7.64
13H1705	VALVE ASSY-HYDRAGAS	9.53	11.20
13H222	USE 13H222P		
13H222P	REAR LAMP LH MINI MK1 (AMBER LENS)	45.53	53.50
13H223	USE 13H223P		
13H223P	REAR LAMP RH MINI MK1 (AMBER LENS)	45.53	53.50
13H23	TAIL LAMP-LATETR2/3/3A	20.38	23.95
13H2776	USE PMZ308		
13H3471A	UNIT-LIGHT	14.59	17.14
13H3471AP	USE GLU104		
13H3891	CLUTCH SLAVE CYLINDER MGC	41.28	48.50
13H4070EVA	USE GTS104		
13H4070EVA	USE GTS104		
13H4216	USE 13H4216P		
13H4216P	REVERSE LIGHT SWITCH 1275CC	20.00	23.50
13H428	USE 216416		
13H429	USE 216417		
13H4393EVA	FLASHER UNIT-ELECTRONIC	5.88	6.91
13H4393EVA	USE GFU2125		
13H503EVA	BELT-VEE ALTERNATOR	3.26	3.83
13H5281EVA	USE URFO08855EVA		
13H5799E	MOTOR-STARTER ENGINE	72.54	85.23
	SURCHARGE	100.00	117.50
13H5799EP	INERTIA STARTER MINI	36.59	42.99
	SURCHARGE	20.00	23.50
13H5799UR	STARTER MOTOR-HI-TORQUE(MINI)	156.59	183.99
13H6284EVA	THERMOSTAT	5.54	6.51
13H6284EVA	USE GTS102		
13H6343	WIPER SWITCH	10.85	12.75
13H6479	REAR LAMP ENQUIRE		
13H6479P	LAMP ASSY-RHR-MINI	46.81	55.00
13H6480	REAR LAMP	95.83	112.60
13H6480P	LAMP ASSY-LHR-MINI	46.81	55.00
13H7286	BUSH	13.44	15.79
13H7286P	BUSH	1.45	1.70
13H7604	THERMOSTAT	8.31	9.76
13H7604P	USE ETC4765P		
13H7922	USE BHM7199		
13H8213EVA	COIL IGNITION	21.10	24.79
13H8213EVA	USE GCL110		

Part Number	Description	Price £ Ex VAT	Price £ Inc VAT
13H9694	DISTRIBUTOR 45D MGB'74> *NEW*	62.13	73.00
142001	HEADLAMP BEZEL	13.40	15.75
148876A	VOLTAGE STABILIZER	7.75	9.11
14A6476	WING	84.04	98.75
14A6476P	RH FRONT WING MINI (NO SIDE REPEATER)	42.13	49.50
14A6477	WING	77.93	91.57
14A6477P	FRONT WING LH MINI (NO SIDE REPEATER)	42.13	49.50
14A6740	CABLE ASSY-TRUNK REL	9.18	10.79
14A6740P	CABLE ASSY-BOOT STAY-MINI	2.55	3.00
14A6779	USE DPB10166		
14A7776P	STRAP-RETAINING	5.50	6.46
14A9559	W/ARCH-LHR MINI	45.53	53.50
14A9988	USE 14A9988P		
14A9988P	CABLE-HEATER	16.59	19.49
154577EVA	USE GFU2221		
154577EVA	USE GFU2204		
17H8152EVA	CYLINDER ASSY-BRAKE	14.67	17.24
17H8152EVA	WHEEL CYLINDER	5.53	6.50
17H8712	TIE ROD MGB	27.23	32.00
17H8735EVA	CYLINDER ASSY-WHEEL REAR BRAKE	23.37	27.46
17H8735EVA	REAR WHEEL CYLINDER	10.64	12.50
17H98	USE 17H98P		
17H98P	FUEL PUMP-S+M '58-63	45.53	53.50
18G1672	HANDLE FOR C/SHAFT LOCK WRENCH	79.95	93.94
18G1770	TOOL	93.62	110.00
18G1770-1	TOOL	20.85	24.50
18G1770-2	TOOL	20.85	24.50
18G8336EVA	USE 18G8336SLP		
18G8336SLP	PAD-BRAKE	16.20	19.04
18G8535EVA	PAD-BRAKE	23.06	27.10
18G8535EVA	BRAKE PAD SET MINI	12.34	14.50
18G8761	BADGE SET-SILL MIDGET	14.26	16.76
18G8905	STEERING LOCK KIT MGBV8	66.38	78.00
1H756	OPR VALVE SPRING MGB	0.99	1.16
213961	USE 213961A		
213961A	SUMP PLUG WASHER	0.81	0.95
216148E	MOTOR & BRACKET ASSY-W/WIPE	97.62	114.70
216148EP	USE 517621		
216416	RH SIDE/FLASHER LAMP(FLAT LENS)	20.64	24.25
216417	LH SIDE/FLASHER LAMP(FLAT LENS)	20.64	24.25
21A1163EVA	JOINT ASSY-KNUCKLE	10.66	12.53
21A1163EVA	USE RBK10007EVA		
21A1202	USE 21A1202P		
21A1202P	CHOKE CABLE MINI MK1/2	15.53	18.25
21A1230	BUSH	1.48	1.74
21A1230POLY	BUSH POLY		ENQUIRE
21A1265	USE SDB000101EVA		
21A1400EVA	USE 21A1400SLP		
21A1400SLP	KIT-HUB BEARING	30.66	36.03
21A1400SLP	WHEEL BRG.FRONT MINI DISC BRAKES	23.62	27.75
21A1882P	BUSH-LOWER ARM(MINI)	1.36	1.60
21A1902	USE 21A1902SLP		
21A1902P	ENGINE MOUNTING-MINI	3.40	4.00
21A1902SLP	MOUNTING-FRONT ENGINE	8.88	10.43
21A2064X	STUD	5.07	5.96
21A2064XP	WHEEL STUD	0.81	0.95
21A2329	CONTROL-CHOKE	7.62	8.95
21A2329P	USE 21A2329		
21A2558	USE 21A2558P		
21A2599	MOUNTING-RR-SUBFRAME	21.15	24.85
21A2599P	MOUNTING-REAR SUBFRAME	2.72	3.20
21A2599SLP	MOUNTING-FRONT SUBFRAME REAR	22.67	26.64
21A2612EVA	DISC-BRAKE	16.19	19.02
21A2612EVA UR	EBG TURBO GROOVE BRAKE DISC *PAIR*	91.06	107.00
21A2612EVA	BRAKE DISC MINI	10.21	12.00
21A2612SLP	DISC-BRAKE	21.32	25.05
21A2624	MOUNT-RUBBER	5.59	6.57
21A2624P	MOUNTING-FRONT SUB FRAME	2.13	2.50
21A2624X	FRT.MOUNTING TEARDROP (ALLOY)	20.85	24.50
21A654	CONNECTOR-BRAKE-2WAY(MINI)	10.05	11.81
22A1018	MOUNTING-ENGINE		ENQUIRE
22A747P	BOLT-FLYWHEEL	6.95	8.17
22A917	MOUNTING-ENGINE	28.23	33.17
237-430	CAR COVER-MGB ROADSTER	108.08	126.99
246005EVA	USE GRA101		
24A2738	USE 24A2738P		
24A2738P	HEATER CABLE MINI TO 89 (NON SERVO)	5.73	6.73
24G6271	WASHER MOTOR,CAP,VALVE	24.68	29.00
251970MINI	MOUNTING ACCESSORY		ENQUIRE
255073MINI	MOUNTING ACCESSORY		ENQUIRE
255078MINI	MOUNTING ACCESSORY		ENQUIRE
256101MINI	MOUNTING ACCESSORY		ENQUIRE
258117MINI	MOUNTING ACCESSORY- PACK OF 10		ENQUIRE
258825MINI	MOUNTING ACCESSORY- PACK OF 10		ENQUIRE
265433403107	USE G265433403107		
26786220Z10120	FRAME	72.99	85.76
26786220Z121	REINFORCEMENT	23.97	28.16
26786220Z14720	CROSSMEMBER	49.17	57.77
26788870Z10220	HOOD	126.07	148.13
269026300154	KIT	44.05	51.76
269026300155	KIT	135.36	159.05
269026300156	KIT	123.96	145.65
269533403103	BEARING	37.71	44.31
270225200114	USE 270225200119		
270225200119	CLUTCH	86.35	101.46
270225400103	COVER	49.50	58.16
270225600105	BEARING	31.73	37.28
270225600112	USE 270225600105		
270232430145	ARM	88.47	103.95
270232430146	ARM	88.47	103.95

Part Number	Description	Price £ Ex VAT	Price £ Inc VAT
270232800113	ANTI ROLL BAR LINK	35.87	42.15
270235108202	SPACER	2.97	3.49
270235607805	SEAL	0.98	1.15
270235608304	SHIM	0.30	0.35
270235608305	SHIM	0.30	0.35
270235608306	SHIM	0.30	0.35
270235608308	SHIM		ENQUIRE
270235608309	SHIM		ENQUIRE
270235608310	SHIM	0.23	0.27
270235608311	SHIM	0.30	0.35
270235608312	SHIM	0.30	0.35
270235609205	WASHER	1.75	2.06
270246600164	BELLOW	17.02	20.00
270246607730	BELLOW	14.21	16.70
270246607731	BELLOW	14.21	16.70
270282409939	BLADE	5.72	6.72
27298	TYRE TREAD DEPTH GAUGE	4.00	4.70
273135603103	USE G273135603102		
277942100114	USE 277942100134		
277942100134	DISC PAD	74.24	87.23
277942100134P	DISC PAD	38.72	45.50
277942103704	DISC	28.11	33.03
277942300121	USE 284242300108		
277942300125	CYLINDER	36.80	43.24
277942300126	CYLINDER	36.80	43.24
277954409932	HEADLAMP	141.29	166.02
277954409933	HEADLAMP	141.29	166.02
279009130123	USE G279009130131		
279009130131	USE G279009130131		
279018130102	USE 279018130103		
279020100103	USE G279020100108		
279020100108	USE G279020100108		
279020120124	THERMOSTAT	14.57	17.12
279023126306	BELT	5.21	6.12
279105116303	BELT	73.94	86.88
279109110102	FILTER	15.81	18.58
279109130117	USE G279009130131		
279115200123	PUMP	144.09	169.31
279123116302	BELT	31.49	37.00
279149100125	CATALYTIC CONVERTER	331.67	389.71
279149100125P	CATALYTIC CONVERTER CITY ROVER	200.85	236.00
279149100128	PIPE	39.63	46.57
279149100138	EXHAUST	128.74	151.27
279150100121	USE ALTERNATIVE - CONTACT US FOR DETAILS		
279215189901	PLUG	4.46	5.24
279850100104	HOSE	2.86	3.36
27H2942EVA	ELEMENT AIR CLEANER	4.00	4.70
27H5981A	USE GLU515		
282032420112	ARM	46.56	54.71
282032420113	ARM	25.53	30.00
282082409917	BLADE	9.72	11.42
282082409918	BLADE	9.72	11.42
28288810Z10120	PANEL	79.85	93.82
28288810Z10220	PANEL	79.86	93.84
28423			

Part Number	Description	Price £ Ex VAT	Price £ Inc VAT
2B290165MINI	EXHAUST ASSY	241.67	283.96
2B290165MINI P	USE 2B290161MINI P		
2B290165SS	USE 2B290161SS		
2B290167MINI	EXHAUST ASSY	251.41	295.41
2B290167MINI P	USE 2B290159MINI P		
2B290167SS	USE 2B290159SS		
2B823857	EXHAUST	172.78	203.02
2C2022	OIL FILTER	3.06	3.60
2C2253	OIL FILTER	5.71	6.71
2C2256	OIL FILTER	12.34	14.50
2C2281	OIL FILTER	9.40	11.05
2C5110	FUEL FILTER	31.01	36.44
2C5117	FUEL FILTER	21.26	24.98
2C8285	AIR FILTER	13.11	15.40
2C8285K-N	K&N AIR FILTER NEW MINI	32.30	37.95
2C8370	AIR FILTER	6.72	7.90
2C8370K-N	K&N AIR FILTER NEW MINI COOPER S	32.30	37.95
2C8437	AIR FILTER	8.54	10.03
2C8437K-N	K&N AIR FILTER NEW MINI	29.75	34.96
2C8573	AIR FILTER	17.50	20.56
2CE426	USE JKRO00030P		
2CEC395	POLLEN FILTER	19.86	23.34
2D10A0865C	COGGED FAN BELT	4.04	4.75
2D6PK892	BELT	11.91	13.99
2GG35452	SHOCK ABSORBER	84.00	98.70
2GG35453	SHOCK ABSORBER	84.00	98.70
2GG51281	SHOCK ABSORBER	47.81	56.18
2M01520001	COIL SPRING	36.01	42.31
2M01520002	COIL SPRING	36.01	42.31
2M01520003	COIL SPRING	44.74	52.57
2M01520004	COIL SPRING	44.74	52.57
2M01520005	COIL SPRING	44.74	52.57
2N3132 BOPR6E-11	SPARK PLUG	3.99	4.69
2N3199 BKR6EQU	SPARK PLUG	12.24	14.38
2N4285	SPARK PLUG	39.20	46.06
2N5665	GLOW PLUG	23.35	27.44
2N6464 BPR6E	SPARK PLUG	4.03	4.74
2P075	ENERGY BATTERY	75.52	88.74
2P075SP	PRESTIGE BATTERY	94.93	111.54
2P077	ENERGY BATTERY	ENQUIRE	
311346	SCISSOR JACK & HANDLE	21.86	25.69
31G1155SLP	PAD-BUFFER	2.36	2.77
31G1155SLPP	BUSH-TIE BAR	0.77	0.90
372360	DOOR LOCK LH ROVER P6	16.38	19.25
372361	DOOR LOCK RH ROVER P6	16.38	19.25
37H2015EVA	CYLINDER-WHEEL-RH	9.25	10.87
37H2015EVA P	WHEEL CYLINDER(MINI)/RHF	5.73	6.73
37H2245R	ALTERNATOR 15 AC	53.62	63.00
	SURCHARGE	50.00	58.75
37H4128E	LHR S/ABSORBER MGA(RECON)	27.19	31.95
	SURCHARGE	50.00	58.75
37H4414EVA	USE GCS101		
37H8225	VACUUM UNIT-DISTR.-45D MINI	27.66	32.50
37H8778A	LINK-REAR S/ABSORBER MGB'75>	9.32	10.95
3N6860	USE PCC105220SLPP		
3N69700A	RADIATOR	140.94	165.60
3N69701A	RADIATOR	195.36	229.55
3N69702A	RADIATOR	158.76	186.54
3N69703A	RADIATOR	252.99	297.26
3N69704A	RADIATOR	207.80	244.17
3P075E	PLATINUM PRESTIGE BATTERY	64.55	75.85
3P075SPPLA	PLATINUM PRESTIGE PLUS BATTERY	83.89	98.57
3S06007	FRONT COIL SPRING	27.79	32.65
3S06008	FRONT COIL SPRING	29.57	34.74
3S06217	FRONT COIL SPRING	31.95	37.54
3S06218	FRONT COIL SPRING	32.95	38.72
3S06219	REAR COIL SPRING	25.40	29.85
3S06220	FRONT COIL SPRING	32.95	38.72
3S06221	FRONT COIL SPRING	33.74	39.64
3S06222	FRONT COIL SPRING	27.79	32.65
3S06223	FRONT COIL SPRING	30.37	35.68
3S06224	REAR COIL SPRING	25.40	29.85
3S06255	FRONT COIL SPRING	30.35	35.66
3S06256	REAR COIL SPRING	31.95	37.54
502096	RELAY - DIRECTION INDICATOR	6.50	7.64
502335	USE GRK4035		
503352	BULB	1.03	1.21
503352P	BULB	0.51	0.60
506114	DRAIN PLUG D TYPE O/D MGB	6.81	8.00
508182A	USE RTC202A		
513772	SPRING H/BRAKE PULL OFF MGB	2.89	3.40
514356	C/SLAVE CYL.1600	22.55	26.50
514578	USE 514578P		
514578P	RUBBER GREASE SACHET	2.30	2.70
517621	WIPER MOTOR NEW (2-SPEED) NO GEARS	46.02	54.07
519059	R/WHL/CYL/REP.K	4.38	5.15
51K281SET	STUD SET-MGB CYL.HEAD	21.06	24.75
520160A	WIPER PARK SWITCH CLIP ON	14.25	16.74
523638A	USE GAT347		
565540EVA	CAP-EXPANSION TANK PRESSURE	4.34	5.10
565540EVA P	USE GRC110		
57-0167	K&N INDUC KIT R214 SPI 16v>VIN605481	43.36	50.95
570758	WASHER BOTTLE BRACKET	3.83	4.50
589715E	ALTERNATOR	59.17	69.52
	SURCHARGE	100.00	117.50
589715EP	USE GXE8211		
59321324EVA	ROTOR HEAD ASSY-DISTRIBUTOR	1.81	2.13
59321324EVA P	ROTOR ARM LUCAS 45D4	1.36	1.60
5L1331	MAIN HARNESS-MINI>76	127.98	150.38
602159A	DIST.DRIVE CAM GEAR V8 EARLY	42.50	49.94
602165	EXH.VALVE V8 EARLY	4.78	5.62

Part Number	Description	Price £ Ex VAT	Price £ Inc VAT
602166	USE 602166A		
602166A	INL.VALVE V8 EARLY	4.69	5.51
602240	OE*SPRING - VALVE	2.73	3.21
602240A	OUT.V/SPRING P6	0.60	0.71
602241	VALVE SPRING INNER P6	2.47	2.90
603173	USE 603173P		
603173P	DIPSTICK 70>85	2.30	2.70
603330A	FLAME TRAP	4.06	4.77
603554	V8 VALVE GUIDE STANDARD	1.80	2.12
603659	USE 603659A		
603659A	SUMP DRAIN PLUG	3.40	4.00
603930	VISC.COUPLE.13 BLD.FAN *NCA*	ENQUIRE	
605191	OE*AIR FILTER V8 CARB.	5.07	5.96
605214	INSTRUCTION MANUAL-ROVER 3.5(P5)	8.00	8.00
605217	USE 605217P		
605217P	DISTRIBUTOR GEAR EARLY V8	30.64	36.00
605358	W/MANUAL ROVER 3LTR/3.5L SAL/COUPE	40.00	40.00
606030A	NON RETURN VALVE SERVO	15.00	17.63
607875	OWNER'S HANDBOOK-ROVER 3500/3500S SER2(P6)	12.00	12.00
608264	PARTS CATALOGUE-ROVER P5-3LTR/3.5	33.00	33.00
621112	REINFORCEMENT PLATE (CAPTIVE PR)	5.11	6.00
62120601011	BULB HEADLAMP H4 60/65W	14.55	17.10
62120601216	BULB 12V 21W	0.56	0.66
62120601402	BULB 12V 5W	0.61	0.72
62120601615	BULB 12V 5W	2.38	2.80
62120601712	BULB 12V 21W	5.84	6.86
83H335	USE 83H335P		
83H335P	LAMP-NO.PLATE-BLACK	21.49	25.25
8510381	OE*VALVE - EXHAUST GAS RECIRCULATION	74.01	86.96
885546010001	BALL JOINT	12.17	14.30
88G221	GASKET-INL MANIFOLD	0.53	0.62
88G221P	GASKET-HEATER TAP	0.38	0.45
88G252	CAMSHAFT MGA-3BRG MGB	104.68	123.00
88G302	BEARING-NEEDLE ROLLER	35.77	42.03
88G302P	BEARING-NEEDLE ROLLER	4.21	4.95
88G322	NUT-STUD	1.58	1.86
88G322P	WHEEL NUT(MINI/S+M)	0.64	0.75
88G520EVA	KIT-HUB BEARING	24.48	28.76
88G563EVA	USE GPS133		
88G198-010	BIG END BEARING SET+010 'A'SERIES	13.40	15.75
8G2389-020	MAIN BEARING SET+020 MGB	16.50	19.39
8G2391-010	MAIN BEARING SET+010 1098/1275CC	12.34	14.50
8G2441-020	PISTON SET 1098CC	114.04	134.00
8G255310	BIG END BEARING SET +010	14.68	17.25
8G2664	B/END BEARING SET STD.MGB'65>	16.50	19.39
8G2664-020	BIG END BEARING SET+020 MGB'65>	16.50	19.39
8G4197EVA	KIT-BALL JOINT	17.09	20.08
8G4197EVA P	BALL JOINT REPAIR KIT	7.95	9.34
8G621	BEARING-FRONT SUSPENSION(MGB)	0.98	1.15
8G7134EVA	KIT-RADIUS ARM REAR SUSPENSION	30.14	35.41
8G7134EVA P	RADIUS ARM FULCRUM PIN REPAIR KIT	10.21	12.00
8G8741	R/W/CYL.REP.KIT	6.81	8.00
8G8814EVA	SET-SHOE REAR BRAKE SYSTEM	9.37	11.01
8G8814EVA P	BRAKE SHOES(MINI/S+M)	7.62	8.95
9403	HEADLAMP GASKET	2.30	2.70
A2KT90123	USE F3HK7794		
A2KT90232	USE F3HK7851		
A2KT90236	USE F3HK2065		
A3P207	12V 5W BA15S	0.46	0.54
A3P233	12V 4W BA9S	0.46	0.54
A3P239	12V 5W FEST 11/38MM 10=1boite	0.61	0.72
A3P380	12V 21/5W BAY15D	0.61	0.72
A3P382	12V 21W BA15S	0.57	0.67
A3P382WA	12V 21W 20MM W.B AMB	3.23	3.80
A3P453	12V 55W H3 UV	2.81	3.30
A3P472	12V 60/55W P43T H4	4.07	4.78
A3P499	1012V 55W PX22D H7	4.07	4.78
A3P501	12V 5W WB	0.46	0.54
AAC460010	BODY SHELL	4235.30	4976.48
AAC460012	BODY SHELL	3995.57	4694.79
AAC460050	BODY SHELL	7605.17	8936.07
AAL460070	CLOSING-FRONT HEADER	33.97	39.91
AAR460020	REINFORCEMENT-VALANCE/A POST RH	8.48	9.96
AAR460030	REINFORCEMENT-VALANCE/A POST LH	16.95	19.92
AAU2298	USE AAU2298P		
AAU2298P	CLUTCH MASTER CYLINDER REPRO.	42.98	50.50
AAU5486A	BONNET BUFFER ADJ.820N	1.50	1.76
AAU5510	REVERSE LAMP MGB/S+M	11.90	13.98
AAU8008A	ATTENUATOR/CLUTCH DAMPER	39.95	46.94
AAU8240	USE STW00010		
AAU8806EVA	KIT-HUB BEARING	25.03	29.41
AAU8806EVA P	WHEEL BRG.FRONT MINI DRUM BRAKES	16.17	19.00
AB606143	SCHREE-SELF TAPPING	0.45	0.53
ABB130050	BULKHEAD-FRONT ASSY	183.53	215.65
ABB140030	BULKHEAD-FRONT ASSY	ENQUIRE	
ABB140040	BULKHEAD FRONT ASSY	370.40	435.22
ABB160010	BULKHEAD FRONT ASSY	392.40	461.07
ABB380120	BULKHEAD-FRONT ASSY	123.87	145.55
ABB45001	BULKHEAD-FRONT ASSY	298.23	350.42
ABB45002	BULKHEAD-FRONT ASSY	31.66	37.20
ABB45003	BULKHEAD-FRONT ASSY	31.66	37.20
ABB460020	BULKHEAD-FRONT ASSY	ENQUIRE	
ABB460030	BULKHEAD-FRONT ASSY	159.31	187.19
ABB460050	BULKHEAD-FRONT ASSY	442.73	520.21
ABB460070	FRONT SPARE WHEEL PANEL	65.00	76.38
ABB470010	BULKHEAD FRONT ASSY	270.00	317.25
ABB470010P	FRONT PANEL-ROVER 25(PATTERN)	196.59	230.99
ABC100030	RADIATOR	29.69	34.89
ABC130060	XMBR-RADIATOR	37.21	43.72

Part Number	Description	Price £ Ex VAT	Price £ Inc VAT
ABC140040	XMBR ASSY-FRONT	8.88	10.43
ABC140050	USE ABC140110		
ABC140110	XMBR ASSY-FRONT	148.61	174.62
ABC38005	CROSSMEMBER-FRONT	26.01	30.56
ABC41007	XMBR ASSY-RADIATOR	38.60	45.36
ABC450050	XMBR ASSY-RADIATOR	100.37	117.93
ABC460100	CROSSMEMBER ASSY-LOWER	52.69	61.91
ABD460040	VALANCE ASSY	141.27	165.99
ABD460050	VALANCE ASSY	141.27	165.99
ABE460060	SIDEMEMBER ASSY-FR	50.00	58.75
ABE460070	SIDEMEMBER ASSY-FR	50.00	58.75
ABE460180	SIDEMEMBER ASSY-FR	50.00	58.75
ABE460190	SIDEMEMBER ASSY-FR	158.01	185.66
ABE460200	SIDEMEMBER ASSY-FRONT	157.47	185.03
ABE460210	SIDEMEMBER ASSY-FRONT	157.25	184.77
ABF31002	PANEL-CLOSING CROSSMEMBER-TOP	8.51	10.00
ABG130080	PLATFORM ASSY-BONNET	ENQUIRE	
ABG140040	PLATFORM ASSY-BONNET	68.83	80.88
ABG160020	PLATFORM & WELD NUT ASSY-BON/LOCK	69.15	81.25
ABG38009	PLATFORM-BONNET LOCK	41.84	49.16
ABG410030	PLATFORM ASSY-BONNET	48.58	57.08
ABG45001	PLATFORM ASSY-BONNET LOCKING	45.88	53.91
ABG460050	PLATFORM ASSY-SPARE WHEEL	50.91	59.82
ABG460080	PLATFORM ASSY-SPARE WHEEL	44.44	52.22
ABG460100	PLATFORM & WELD NUT ASSY-BON/LOCK	87.86	103.24
ABG470010	PLATFORM ASSY-BONNET LOCKING	44.17	51.90
ABH130030	HEADLAMP MTG ASSY	54.04	63.50
ABH130040	HEADLAMP MTG ASSY	54.23	63.72
ABH140080	HEADLAMP MTG ASSY	15.45	18.15
ABH140090	HEADLAMP MTG ASSY	ENQUIRE	
ABH140180	HEADLAMP MTG ASSY	51.03	59.96
ABH140190	HEADLAMP MTG ASSY	51.03	59.96
ABH38008	BRACKET-MTG-HEADLAMP	29.83	35.05
ABH38009	BRACKET-MTG-HEADLAMP	35.80	42.07
ABH380200	HEADLAMP MTG ASSY	ENQUIRE	
ABH380210	HEADLAMP MTG ASSY	7.40	8.70
ABH41012	HEADLAMP MTG ASSY	33.09	38.88
ABH41013	HEADLAMP MTG ASSY	33.92	39.86
ABH460020	USE ABH460101		
ABH460030	USE ABH460111		
ABH460101	HEADLAMP MOUNTING ASSY	59.51	69.92
ABH460111	HEADLAMP MOUNTING ASSY	66.21	77.80
ABH470080	HEADLAMP MOUNTING ASSY	31.58	37.11
ABH470090	HEADLAMP MOUNTING ASSY	31.58	37.11
ABK103	USE RP1144		
ABU130190	BRKT ASSY-CENTR STAY	12.08	14.19
ABU140360	BRKT ASSY-CENTR STAY	15.30	17.98
ABU140640	BRKT ASSY-CENTR STAY	27.81	32.68
ABU140660	BRKT ASSY-CENTR STAY	30.3	

ADU8116EVAP-AWZ100790

WEB ORDER - YOU SHOP - WE DELIVER. www.rimmerbros.co.uk

Part Number	Description	Price £ Ex VAT	Price £ Inc VAT
ADU8116EVAP	USE GCL132		
ADU8335	TENSIONER-DRIVE BELT	54.58	64.13
ADU8532EVA	CAP-DISTRIBUTOR IGNITION	4.02	4.72
ADU8798EVA	USE GCB10914		
ADU8814EVA	CAP-DISTRIBUTOR IGNITION	8.28	9.73
ADU8814EVA	DISTRIBUTOR CAP	3.49	4.10
ADU9102	VALVE ASSY-COOLANT	28.06	32.97
ADU9102P	VALVE ASSY-COOLANT MINI	18.30	21.50
ADU9475EVA	KIT-HUB BEARING	42.89	50.40
ADU9475EVA	WHEEL BEARING KIT	24.82	29.16
ADU9549EVA	JOINT-BALL	16.99	19.96
ADU9549EVA	UPPER BALL JOINT	12.99	15.28
ADU9617EVA	KIT-HUB BEARING	35.73	41.98
ADU9617EVA	KIT-HUB BEARING	26.38	31.00
ADU9665EVA	KIT-HUB BEARING	40.84	47.99
ADU9665EVA	KIT-HUB BEARING	26.81	31.50
ADU9779EVA	CARTRIDGE-DIESEL FUEL FILTER	6.77	7.95
ADU9779EVA	USE AEU2147P		
ADU9800E	MOTOR-STARTER ENGINE	78.84	92.64
	SURCHARGE	100.00	117.50
ADU9800EP	PRE ENG STARTER MINI	68.08	79.99
	SURCHARGE	30.00	35.25
ADU9800UR	STARTER MOTOR HI-TORQUE MINI	156.59	183.99
ADU9826EVA	OIL FILTER	7.25	8.52
ADU9826EVA	OIL FILTER	5.11	6.09
ADU9830	GLOW PLUG	12.33	14.49
ADU9878EVA	BELT-DRIVE-TIMING	27.90	32.78
ADU9878EVA	BELT-DRIVE-TIMING	13.62	16.00
ADU9955	GLOW PLUG 2400/2500TD	15.34	18.02
ADU9955P	GLOW PLUG 2400/2500TD	6.00	7.05
ADU9982EVA	USE URF009100EVA		
ADU9986EVA	USE URF009065EVA		
AEA312P	CRANK BOLT	8.51	10.00
AEU1581A	'P' PIPE CLIP	0.85	1.00
AEU2147LP	FILTER ELEMENT	3.07	3.61
AEU2218EVA	FILTER OIL	3.44	4.04
AFC460010	CROSSMEMBER-LUGGAGE FLOOR FRONT	37.95	44.59
AFC460020	MEMBER-LONGTDL ASSY	74.56	87.61
AFC460030	MEMBER LONGITUDINAL ASSY-LUGGAGE	105.42	124.30
AFP0663	SEMS-HEXAGONAL SOCKET	0.40	0.47
AFP1523	DOOR	197.83	232.45
AFP1523BMT	T/GATE-BOTTOM REPAIR(METRO'80-'84)	18.08	21.24
AFP1523LWRSKIN	T/GATE-LOWER SKIN REPAIR (METRO'80-'84)	18.72	22.00
AFP1536	USE AFP1536P		
AFP1536P	HEADLAMP PANEL-RH MTMETRO'84-90	37.50	44.06
AFP1537	USE AFP1537P		
AFP1537P	HEADLAMP PANEL-LH METRO'84-90	37.50	44.06
AFP572	FENDER-FRONT RH	25.53	30.00
AFP906	PANEL-FRONT-LOWER	8.51	10.00
AFR460100	REINFORCEMENT-LUGGAGE FLOOR	9.21	10.82
AFU3235	HEADLAMP-COMPLETE		ENQUIRE
AFU3236	HEADLAMP-COMPLETE	96.74	113.67
AFU3389	LAMP-DIRECTION IND	17.86	20.99
AFU4001	GROMMET	3.00	3.53
AFU4067	HEADLAMP ASSY	91.80	107.87
AFU4068	HEADLAMP ASSY	102.25	120.14
AFU4069	HEADLAMP COMPLETE	10.04	11.80
AFU4070	HEADLAMP COMPLETE		ENQUIRE
AFU4481	USE AFU4481P		
AFU4481P	REPEATER BULB	0.13	0.15
AGG460020	FLOOR-LUGGAGE	75.46	88.67
AGW460100	BRACE ENGINE BAY	10.48	12.31
AGW460110	BRACE ENGINE BAY	10.48	12.31
AHA460210	DASH UPPER ASSY	49.88	58.61
AHA5746	USE AHA5746P		
AHA5746P	ACCELERATOR CABLE MIDGET 1275CC	3.56	4.18
AHA5818	MOULDING-REAR WING	19.79	23.25
AHA8093	USE AHA8093P		
AHA8093P	REAR ROAD SPRING MIDGET 1275	44.25	51.99
AHA9447	CLIP-MOULDING	0.81	0.95
AHA9458	BUMPER BLADE-RHR	40.85	48.00
AHA9459	BUMPER BLADE-LHR	45.53	53.50
AHA9956	USE AHA9956E		
AHA9956E	STG,RACK RECON RHD SPRITE+MIDGET	52.77	62.00
	SURCHARGE	50.00	58.75
AHC31	USE AHC31P		
AHC31P	REAR SPRING(OE SPEC)GT'65-75	44.25	51.99
AHH5258	FACIA BADGE "MG"	7.02	8.25
AHH5261C	BADGE SET MG 3-PIECE	7.02	8.25
AHH6079	BOOT LID BADGE "MGB"ROADSTER	3.83	4.50
AHH6091	USE GSR3359E		
AHH6103SBL	MOULDING SET(GENUINE)MGB/C	41.66	48.95
AHH6205POLY	FRONT SUSP BUSH [MGB]	4.94	5.80
AHH6206POLY	SUSPENSION BUSH [MGB]	4.94	5.80
AHH6208	USE AHH6208P		
AHH6208BK	BOLT KIT-FRT. BUMPER FITTING	10.21	12.00
AHH6208P	FRONT BUMPER MGB/C+V8	96.17	113.00
AHH6261	USE AHH6261P		
AHH6261BK	BOLT KIT-REAR BUMPER	7.79	9.15
AHH6261P	REAR BUMPER MGB/C+V8	137.02	161.00
AHH6281	HOSE-FUEL FILLER MGB	32.95	38.72
AHH6348	SEAL-DOOR OUTER-RH MGB	3.79	4.38
AHH6349	SEALDOOR OUTER-LH MGB	3.66	4.30
AHH6362C	CLUTCH PIPE(MGB/MIDGET)-RH	10.21	12.00
AHH6451	USE AHH6451P		
AHH6451P	SPRING FRONT MGB ROADSTER CHR.BPR.	12.13	14.25
AHH6514	FRONT BUMP STOP MGB	5.32	6.25

Part Number	Description	Price £ Ex VAT	Price £ Inc VAT
AHH6514K	FRONT BUMP STOP KIT MGB	8.51	10.00
AHH6543A	USE AHH6543AP		
AHH6543AP	LINK-ARB-RH MGB	10.21	12.00
AHH6544A	USE AHH6544AP		
AHH6544AP	LINK-ARB-LH MGB	10.21	12.00
AHH6553	USE AHH6553P		
AHH6553P	CLUTCH MASTER CYLINDER-MGB ->67	51.06	60.00
AHH6716P	BATTERY COVER (2 X 6V.)	24.25	28.49
AHH7933	WISHBONE BUSH MGB	0.55	0.65
AHH7933K	WISHBONE BUSH SET (8)	3.07	3.61
AHH8462	USE AHH8462P		
AHH8462P	ACCELERATOR CABLE MGB '62-'74	2.81	3.30
AHU1048EVA	USE GLP138		
AHU1448	USE ADU5738		
AHU1672	SEAL-HOUSING SELECTOR SHAFT	2.17	2.55
AHU1672P	SEAL-SELECTOR SHAFT	0.55	0.65
AHU1959P	SEAL-OIL	1.79	2.10
AHU2198	SEAL-OIL	8.36	9.82
AHU2198P	SEAL-OIL	3.23	3.80
AHU2592	SIDE REPEATER LAMP	2.98	3.50
AJM102EVA	GASKET-CYLINDER HEAD	14.83	17.43
AJM102EVA	GASKET-CYLINDER HEADSET	10.21	12.00
AJM1112	RADIO AERIAL (NOT Dolomite)	4.21	4.95
AJM1117	USE AJM1117P		
AJM1117P	W/ARCH EXTENSION KIT(SET 4)-BLACK	20.42	23.99
AJM1140EVA	GASKET SET-CYLINDER HEAD	13.40	15.75
AJM1163EVA	GASKET-CYLINDER HEAD	26.40	31.02
AJM1163EVA	CYL.HEAD GASKET SET MGB	10.64	12.50
AJM302EVA	GASKET-CYLINDER HEAD 'A' SERIES 998CC	3.06	3.60
AJM402	USE 12H3700EVA		
AJU1136	STUD	1.06	1.25
AK606075	NUT-SPRING-U TYPE	0.84	0.99
AK614017	NUT-SPRING-U TYPE	1.26	1.48
AKD3891G	MINI COOPER & S' MK1 HANDBOOK "S.O.O"10.00	10.00	10.00
AKD8468	ROM ENG MGB GT V8	18.25	18.25
AKE5155	CRASH RAIL '63-'73 MGB	62.13	73.00
AKF1786	BULB-HEADLAMP-H3-55 WATT		ENQUIRE
AKM3621	WORKSHOP MANUAL ROVER 3500/3500S	P639.95	39.95
AKM3661	OWNERS HANDBOOK-MGB'76->	8.00	8.00
AKM7007ENG	ROVER 200 COUPE HANDBOOK	26.61	31.27
AKM7035ENG	ROVER 800 HANDBOOK	25.96	30.50
AKM7220ENG	DHB ENG	27.52	27.52
ALA3647	CLIP-TRIM MIDGET	0.24	0.28
ALA460060	BODY SIDE	98.46	115.69
ALA460070	BODY SIDE	100.92	118.58
ALA460120	TORNEAU ASSY-REAR	372.89	438.15
ALA460130	BODY SIDE ASSY	372.89	438.15
ALA5660	SCUTTLE ASSY	24.29	28.54
ALA5660P	'A'PANEL-RH-MINI'69->	6.38	7.50
ALA5661	SCUTTLE ASSY	24.29	28.54
ALA5661P	'A'PANEL-LH-MINI'69->	6.38	7.50
ALA5666LOWER	REAR WING-LOWER RH(MINI MK3/CLUB)	36.17	42.50
ALA5667LOWER	REAR WING-LOWER-LH(MINI MK3/CLUB)	28.94	34.00
ALA6417	PANEL ASSY-UPPER-RR	325.96	383.00
ALG460040	SILL-OUTER	60.50	71.09
ALG460050	SILL-OUTER	60.50	71.09
ALH38004	RH REAR WING R200 CABRIOLET 89->	63.83	75.00
ALH38006	LH REAR WING R200 CABRIOLET 89->	80.85	95.00
ALH460040	TORNEAU ASSY	238.68	280.45
ALH460080	TORNEAU ASSY	250.88	294.78
ALH460090	TORNEAU ASSY	250.88	294.78
ALJ380740	RH REAR WING R400 (XW) TOURER	63.83	75.00
ALJ380750	LH REAR WING R400 (XW)TOURER	63.83	75.00
ALJ460061	QUARTER & WELD NUT ASSY-INNER	130.06	152.82
ALJ460071	QUARTER & WELD NUT ASSY-INNER	130.95	153.87
ALK460060	WHEELARCH-REAR-OUTER	23.44	27.54
ALK460070	WHEELARCH-REAR-OUTER	23.44	27.54
ALR6871	OE'SCREW M10 X 25	1.33	1.56
ALU1403L	OE'WASHER	0.76	0.89
ALU1403LP	WASHER	0.27	0.32
ALU1438	USE ALU1438L		
ALU1438L	OE'BEARING - BALL - DOUBLE GROOVED	0.28	0.33
ALX460060	EXTENSION-OUTER SILL FRONT	26.26	30.86
ALX460070	EXTENSION-OUTER SILL FRONT	30.36	35.67
ALX460080	EXTENSION-REAR LAMP APERTURE	4.65	5.46
ALX460090	EXTENSION-REAR LAMP APERTURE	4.65	5.46
AME460260	CLOSING-REAR QUARTER TO REAR TORNEAU	5.00	5.88
AME460270	CLOSING-RR QTR-TONN	7.88	9.26
AME460400	CLOSING ASSY-FRONT SILL OUTER	5.00	5.88
AME460410	CLOSING ASSY-FRONT SILL OUTER	19.04	22.37
AMR1421	HOLDER-BULB-LIGHTING	9.21	10.82
AMR6676	OE'NON RETURN VALVE	2.20	2.59
AMR6676P	NON RETURN VALVE	0.85	1.00
ANR3052	OE'WHEEL CHOCK	5.26	6.18
APN460011	LID-HOODWELL		ENQUIRE
APW100010	SEAL-LID-HOODWELL	23.49	27.60
AQA100010	BODY ASSY-REAR	113.60	133.48
AQA140010	BODY ASSY-REAR	196.92	231.38
AQA160010	BODY ASSY-REAR	189.33	222.46
AQA38002	BODY ASSY-REAR	72.34	85.00
AQA38007	BODY ASSY-REAR		ENQUIRE
AQA380230	REAR LOWER PANEL ASSY	63.83	75.00
AQA41003	BODY-REAR	235.29	276.47
AQA460020	BODY ASSY-REAR	288.50	338.99
AQA460050	BODY-REAR	101.12	118.82
AQA460070	BODY ASSY-REAR	122.32	143.73
AQA470010	BODY ASSY-REAR	161.76	190.07
AQA500010	BODY ASSY-REAR	241.92	284.26
AQA500030	BODY ASSY-LOWER REAR	186.36	218.97
AQC140010	CROSSMEMBER ASSY	56.74	66.67

Part Number	Description	Price £ Ex VAT	Price £ Inc VAT
AQC160020	XMBR ASSY-BUMPER	52.88	62.13
AQR460060	REINFORCEMENT-STRIKER	17.41	20.46
AQR460080	REINFORCEMENT ASSY-BODY REAR RAIL	72.73	85.46
AQV460020	MOUNTING-REAR LAMP	30.18	35.46
AQV460030	MOUNTING-REAR LAMP	30.18	35.46
ARA221	13 ROW OIL COOLER 1/2 BSP	44.25	51.99
ARA2634B	FILLER PLUG BRASS	4.78	5.62
ARA2634PLASTIC	FILLER PLUG PLASTIC	4.21	4.95
ARH260	RADIATOR MGB'62-'67	129.95	152.69
ARP2000EVA	RADIATOR ASSY	58.68	68.95
ASB100010	FENDER-FRONT ASSY	138.20	162.39
ASB100010P	FRONT WING-RH(PATTERN)	93.62	110.00
ASB100020	FENDER-FRONT ASSY	135.86	159.64
ASB100020P	FRONT WING-LH(PATTERN)	77.45	91.00
ASB140040	FENDER-FRONT	114.70	134.77
ASB140040P	RHF WING(PATTERN)	40.42	47.49
ASB140050	FENDER-FRONT	114.70	134.77
ASB140050P	LHF WING(PATTERN)	40.42	47.49
ASB140080	FENDER-FRONT	128.57	151.07
ASB140090	FENDER-FRONT	128.57	151.07
ASB160020	FENDER-FRONT	142.47	168.25
ASB160030	FRONT LH WING (BODYKIT OPTION - 5D ON)	42.55	50.00
ASB360010	FENDER-FRONT ASSY	78.01	91.66
ASB38030	FENDER-FRONT	91.87	107.95
ASB38031	FENDER-FRONT	91.87	107.95
ASB41024	FENDER-FRONT	130.00	152.75
ASB41025	FENDER-FRONT		ENQUIRE
ASB41030	RH FRONT WING (2 DOOR COUPE)	42.55	50.00
ASB41031	LH FRONT WING (2 DOOR COUPE)		ENQUIRE
ASB45002	FENDER-FRONT	114.70	134.77
ASB45003	FENDER-FRONT	114.70	134.77
ASB460021	FENDER ASSY-FRONT	210.76	247.64
ASB460031	FENDER ASSY-FRONT	210.77	247.65
ASB470040	FENDER-FRONT	120.18	141.21
ASB470040P	RHF WING(PATTERN)	37.87	44.50
ASB470050	FENDER-FRONT	124.47	146.25
ASB470050P	LHF WING(PATTERN)	38.72	45.50
ASB500020	FENDER-FRONT ASSY	151.71	178.26
ASB500030	FENDER-FRONT ASSY	151.71	178.26
ASJ36002	FRONT VALANCE MINI TO 1997'OE	167.25	196.52
ASJ36002P	FRONT VALANCE MINI TO 1997	53.62	63.00
ASJ360070	GRILLE ASSY-FRONT	156.64	184.05
ASU1816EVA	ELEMENT AIR CLEANER		ENQUIRE
ASU1816EVA	USE PHIE10021EVA		
ASU1816GSLP	ELEMENT AIR CLEANER	9.08	10.67
ATU1040A	GROMMET	1.15	1.35
AUD135PR	CARBS RECON PAIR(HS4)MGB 1966	217.87	256.00
	SURCHARGE	40.00	47.00
AUD278PR	CARBS RECON PAIR (HS4) MGB	217.87	256.00
	SURCHARGE	30.00	35.25
AUF214	FUEL PUMP ASSY1098/1275(SU)	65.53	77.00
AUF214EP	ELECTRIC FUEL PUMP POSITIVE	74.04	87.00
	SURCHARGE	10.00	11.75
AUF214P	FUEL PUMP ASSY1098/1275	42.13	49.50
AUU1690EVA	ROTOR HEAD ASS		

Part Number	Description	Price £ Ex VAT	Price £ Inc VAT
AWZ100800	PAINT-PENCIL (NIGHTFIRE RED 2)	7.56	8.88
AWZ100810	PAINT-PENCIL	8.01	9.41
AWZ100900	VOLCANO AEROSOL	ENQUIRE	
AWZ100910	PAINT-PENCIL	ENQUIRE	
AWZ101170	PAINT-AEROSOL (BROOKLANDS GREEN)	10.91	12.82
AWZ101200	PAINT-PENCIL (BROOKLANDS GREEN)	7.24	8.51
AWZ101270	PAINT-PENCIL	7.15	8.40
AWZ101290	PAINT-AEROSOL (ANTHRACITE)	10.21	12.00
AWZ101520	PAINT-PENCIL	6.03	7.09
AWZ101590	PAINT-AEROSOL SPRAY	9.25	10.87
AWZ101690	PAINT-AEROSOL SPRAY	10.04	11.80
AWZ101700	PAINT-AEROSOL (MULBERRY RED)	ENQUIRE	
AWZ101720	PAINT-AEROSOL (MORELLO PURPLE)	ENQUIRE	
AWZ101730	PAINT-AEROSOL SPRAY	11.19	13.15
AWZ101760	PAINT-PENCIL (MULBERRY RED)	ENQUIRE	
AWZ101790	PAINT-PENCIL (MORELLO PURPLE)	ENQUIRE	
AWZ101790	PAINT-PENCIL	6.52	7.66
AWZ101800	PAINT-PENCIL	7.89	9.27
AWZ102000	PAINT-AEROSOL SPRAY	10.91	12.82
AWZ102010	PAINT-AEROSOL (ALUMINA GREEN)	10.91	12.82
AWZ102030	PAINT-PENCIL	7.75	9.11
AWZ102040	PAINT-PENCIL	5.89	6.92
AYP10002	SCREW-DOG POINT	0.90	1.06
AZQ000020	BULB	40.55	47.65
AZQ000030	BULB	6.24	7.33
AZX1311	FUEL PUMP ORIG	72.15	84.78
AZX1311 ELECT	SU FUEL PUMP ELECTRON SURCHARGE	98.68 15.00	115.95 17.83
AZX1311ALT	FUEL PUMP ASSY.	54.89	64.50
AZX1311P	USE AZX1311ALT		
AZX1331	ELECTRIC FUEL PUMP (DUAL POLARITY)	85.96	101.00
AZX1332P	FUEL PUMP MGA/MGB>65	62.13	73.00
AZX1817	PUMP-FUEL-MECHANICAL	66.46	78.09
AZX1817P	MECH.FUEL PUMP	29.79	35.00
AZX1818	PUMP-FUEL-MECHANICAL	73.28	86.10
AZX1818P	PUMP-FUEL-MECHANICAL	54.47	64.00
AZX1823	FUEL PUMP	49.37	58.01
AZX1823P	FUEL PUMP	33.19	39.00
BAC000190	LABEL-UNDERBONNET AIR CONDITIONING	1.13	1.33
BAC10135	LABEL-BONNET OR HOOD CLOSURE	1.23	1.45
BAC10200A	LABEL-WARN-AIR BAG	1.34	1.57
BAC102590	LABEL-AIR CON	2.17	2.55
BAC102710	LABEL-SECURITY-B/ALM	1.90	2.23
BAC102740	LABEL-BONNET LOCK PLATFORM E MARK	1.36	1.60
BAU001120EVA	USE BAU001120EVA		
BAU001120EVA	STEERING RACK BOOT KIT	11.41	13.41
BAU1074A	SWITCH (REMOTE)	6.50	7.64
BAU1074AU	G/BOX SWITCH REMOTE USD	3.35	3.94
BAU1177A	H/L KIT 45/40W LHD&PIL	48.36	56.82
BAU1177AUPRATED	H/L KIT 60/55W LHD&PIL	54.08	63.54
BAU2019EVA	KIT-BOOT-CONSTANT VELOCITY JOINT	14.36	16.87
BAU2019EVA	CV BOOT KIT	4.70	5.52
BAU2043A	GROMMET	1.52	1.79
BAU2225A	USE GXE2257		
BAU2361EVA	USE GSV1062		
BAU2368	LENS/HOUSING ASSY-RR	ENQUIRE	
BAU2369	LENS/HOUSING ASSY-RR	58.23	68.42
BAU5026	LAMP ASSY-REAR	49.56	58.23
BAU5027	LAMP ASSY-REAR	49.56	58.23
BAU5134	LENS AND HOUSING-RH	6.70	7.87
BAU5135	LENS AND HOUSING-LH	64.28	75.53
BAU5345	SWITCH-INDICATOR	48.94	57.50
BAU5345P	SWITCH-INDICATOR	36.17	42.50
BAU5346	SWITCH-WASH/WIPE	37.45	44.00
BAU5441	KIT-GAITER-OUTER JOINT DRIVESHAFT	11.63	13.67
BAU5441P	BOOT KIT WITH STEEL BAND	9.06	10.65
BAU5444	SOLENOID	112.27	131.92
BAU5633	KIT-GUIDE PIN-RR	46.90	55.11
BAU5703	SOLENOID	108.17	127.10
BAU5722EVA	KIT-STEERING BELLOWS	18.27	21.47
BAU5722EVA	STEERING RACK BOOT KIT	7.53	8.85
BAU5837	LHR.LAMP ASSY. ->VIN 258440	20.00	23.50
BDA31002	DOOR ASSY-FRONT	243.55	286.17
BDA31003	DOOR ASSY-FRONT	239.26	281.13
BDA32004	SHELL ASSY-DOOR-RH	339.50	398.91
BDA32005	SHELL ASSY-DOOR-LH FRONT	100.00	117.50
BDA32005 DAMAGED	SHELL ASSY-DOOR-LH FRONT	75.00	88.13
BDA32011	PANEL-DOOR-OUTER-LH	28.11	33.03
BDA381700	DOOR ASSY-FRONT RH.	85.11	100.00
BDA381820	DOOR ASSY. RH.FRONT 3DOOR SAL	63.83	75.00
BDA381870	DOOR ASSY-FRONT LH CABRIOLET	100.00	117.50
BDA381880	DOOR ASSY R.H. COUPE 92>	106.38	125.00
BDA39014	RH FRONT DOORSKIN (1990 ON)	29.79	35.00
BDA39015	DOOR SKIN L.H. 3DR METRO 90>	21.28	25.00
BDA39016	DOOR-FRONT-OUTER	34.04	40.00
BDA39017	DOOR SKIN L.H.FRONT 5DR METRO 90>	21.28	25.00
BDA390520	RH FRONT DOOR (3 DOOR FROM BD)	80.85	95.00
BDA41010	DOOR SKIN R.H.FRONT ROVER 800 91>	21.28	25.00
BDA41011	DOOR SKIN L.H.FRONT ROVER 800 91>	21.28	25.00
BDA41018	DOOR ASSY-FR-OUTER	111.49	131.00
BDA41019	DOOR ASSY-FR-OUTER	120.00	141.00
BDA41036	DOOR ASSY. R.H. ROVER 800 COUPE 91>	63.83	75.00
BDA41037	DOOR ASSY L.H. ROVER 800 COUPE 91>	63.83	75.00
BDA410440	DOOR ASSY R.H.FRONT ROVER 800 91>	63.83	75.00
BDA410450	DOOR ASSY L.H.FRONT ROVER 800 91>	63.83	75.00
BDA460041	DOOR-OUTER FRONT	154.28	181.28
BDA460051	DOOR-OUTER FRONT	154.28	181.28
BDA460120	DOOR ASSY-FRONT-RH	495.90	582.68
BDA460130	DOOR ASSY-FRONT-LH	495.90	582.68
BDB460020	HINGE ASSY-FRONT DOOR UPPER	25.32	29.75

Part Number	Description	Price £ Ex VAT	Price £ Inc VAT
BDB460030	HINGE ASSY-FRONT DOOR UPPER	25.32	29.75
BDB460040	HINGE ASSY-FRONT DOOR LOWER	25.32	29.75
BDB460050	HINGE ASSY-FRONT DOOR LOWER	24.23	28.47
BDU1487	PLUG-CORE	0.51	0.60
BDU1573	USE LPF00132EVA		
BDU1588N	PUMP-FUEL INJECTION	2103.89	2472.07
BDU2441	PUMP-FUEL	56.80	66.74
BDU2441P	FUEL PUMP	30.07	35.33
BEP1012	PANEL-BODY REAR-LOWER - VAN	14.89	17.50
BEP1399	DOOR ASSY-REAR-LH VAN	ENQUIRE	
BEP2142	PANEL-SILL-OUTER-RH	10.64	12.50
BEP2143	USE BEP2143P		
BEP2143P	LH FULL SILL PANEL(PATTERN)	29.36	34.50
BEP2386	RH FRONT WING (STEEL BUMPER)	34.04	40.00
BEP2387	LH.FRONT WING (STEEL BUMPER)	34.04	40.00
BEP2390	RH FRONT WING (MOULDED BUMPER)	ENQUIRE	
BEP2391	USE BEP2391P		
BEP2391P	LHF WING-MAESTRO 2/86>(PATTERN)	69.79	82.00
BEP526	DOOR HINGE FRONT UPPER	ENQUIRE	
BEP708	PANEL-TAIL LAMP SURROUND-RH	8.51	10.00
BEP709	PANEL-TAIL LAMP SURROUND-LH	8.51	10.00
BEP755	USE BEP755P		
BEP755P	MAESTRO BONNET	137.02	161.00
BEP913	PANEL-WINDSHIELD SCUTTLE	ENQUIRE	
BEP968	RH FRONT DOORSKIN	ENQUIRE	
BEP969	LH FRONT DOORSKIN	ENQUIRE	
BEP970	RH REAR DOORSKIN	ENQUIRE	
BEP971	LH REAR DOORSKIN	25.53	30.00
BFA31002	SHELL ASSY-DOOR-RH	100.00	117.50
BFA32002	SHELL ASSY-DOOR-RH	319.14	374.99
BFA32003	SHELL ASSY-DOOR-LH	319.14	374.99
BFA32008	SHELL ASSY-DOOR-RH	85.11	100.00
BFA32009	SHELL ASSY-DOOR-LH	372.74	437.97
BFA32016	PANEL-DOOR-OUTER-RH	88.76	104.29
BFA32017	PANEL-DOOR-OUTER-LH	34.04	40.00
BFA380400	RH REAR DOOR (XW)	85.11	100.00
BFA380410	LH REAR DOOR	85.11	100.00
BFA39010	DOOR SKIN R.H.REAR METRO BD1001 ON	21.28	25.00
BFA39011	DOOR SKIN L.H.REAR METRO BD1001 ON	21.28	25.00
BFA390140	RH REAR DOOR	85.11	100.00
BFA410280	DOOR-REAR-OUTER	19.05	22.38
BFA410290	DOOR-REAR-OUTER	ENQUIRE	
BFA410300	DOOR ASSY-REAR RH	85.11	100.00
BFA410310	DOOR ASSY L.H.REAR ROVER 800 SAL 86>	63.83	75.00
BFH38004	CHECKER ASSY-FRONT DOOR	14.23	16.72
BFS989	BULB-989-5 WATT	0.48	0.56
BH112321	BOLT	1.56	1.83
BHA160180SLP	TAILGATE ASSY - PAINTED	127.66	150.00
BHA38084	TAILGATE ASSY 3/5 DOOR	63.83	75.00
BHA380940	TAILGATE ASSY. ROVER 400 TOURER	80.85	95.00
BHA39001	TAILGATE ASSY (NON SPOILER TYPE)	63.83	75.00
BHA39007	TAILGATE ASSY (SPOILER TYPE)	63.83	75.00
BHA4175	USE BHA4175P		
BHA4175P	REAR LAMP TO 69	48.47	56.95
BHA4283	USE BHA4283P		
BHA4283P	NO. PLATE LAMP 62-73	15.53	18.25
BHA4380E	GUJAGE-TACHO MGB/S-M'64-67 SURCHARGE	64.68 50.00	76.00 58.75
BHA4602	USE BHA4602P		
BHA4602P	VOLTAGE STABILISER	11.90	13.98
BHA4615	USE AAU2298		
BHA4628	SWITCH-INDICATOR >69 MGB/S+M	50.21	59.00
BHA4675	USE BHA4675P		
BHA4675P	BRAKE LIGHT SWITCH	14.68	17.25
BHA4789	4TR 15AC C/BOX	32.97	38.74
BHA4806	MIRROR-INTERIOR MGB'62-69	16.81	19.75
BHA4966	USE UKC5992		
BHA4973P	STOP/TAIL LAMP '69ON	48.51	57.00
BHA5298	USE BHA5298P		
BHA5298P	HEATER VALVE-MGB	16.38	19.25
BHA5301	NO.PLATE LAMP 1974*NLA*	ENQUIRE	
BHA5318	USE BHA5318P		
BHA5318P	INDICATOR LAMP 1500 MIDGET (UK)	59.56	69.98
BHA5322	USE BHA5322P		
BHA5322P	INDICATOR LAMP MGB '74>UK	30.21	35.50
BHH1077	USE BHH1077P		
BHH1077P	FRONT SPRG. GT. CHR.BPR.	11.90	13.98
BHH1225	USE BHH1225P		
BHH1225P	FRONT COIL SPRING	11.90	13.98
BHH1351	USE BHH1351P		
BHH1351P	RH ENGINE MOUNTING MGB(CHR.BUMPER)	4.08	4.79
BHH1352	USE BHH1352P		
BHH1352P	LH ENGINE MOUNTING-MGB(CHR.BUMPER)	4.08	4.79
BHH1621P	USE BHH1621P		
BHH1621P	ENGINE MOUNTING MGB'76>	5.32	6.25
BHH1648	USE BHH1648P		
BHH1648P	ACCELERATOR CABLE MGB '74>RHD	5.96	7.00
BHH1767	USE BHH1767P		
BHH1767P	REAR SPRING(T-LEAF)MGB GT	44.25	51.99
BHH1779	USE BHH1779P		
BHH1779P	REAR SPRING ROADSTER 75>	46.81	55.00
BHH505	BAFFLE PLATE LH MGB/C 1962-1970	13.87	16.30
BHH922	RHF SEAT BASE FOAM MGB'73ON	18.30	21.50
BHH923	LHF SEAT BASE FOAM MGB'73ON	18.30	21.50
BHM1183-020	PISTON RING SET MGB 18v +020	21.90	25.73
BHM1183-040	PISTON RING SET MGB 18v +040	21.90	25.73
BHM13LHP	INNER SILL-LH(MINI)	12.34	14.50
BHM13RHP	INNER SILL-RH(MINI)	12.34	14.50
BHM536	USE BHM536P		
BHM536P	BUMPER COVER-MGB FRONT	395.73	464.98

Part Number	Description	Price £ Ex VAT	Price £ Inc VAT
BHM537	USE BHM537P		
BHM537P	RR BUMPER COVER MGB	395.73	464.98
BHM7012EVA	KIT-GAITER-OUTER JOINT DRIVESHAFT	4.65	5.46
BHM7058	HEADLAMP ADJUSTING KIT	3.73	4.38
BHM7196	HEADLAMP ASSY	49.15	57.75
BHM7198	HEADLAMP ASSY	139.18	163.54
BHM7199	H/L KIT S/BEAM RHD&PIL	28.33	33.29
BHM7205	USE BHM7012EVA		
BKA130020	BONNET ASSY	151.47	177.98
BKA140040	BONNET ASSY	ENQUIRE	
BKA140100	BONNET ASSY	342.19	402.07
BKA32002	PANEL-BONNET	80.85	95.00
BKA360070	BONNET ASSY	154.41	181.43
BKA360110	BONNET ASSY	154.41	181.43
BKA38032	BONNET ASSY	ENQUIRE	
BKA38042	BONNET ASSY	ENQUIRE	
BKA38067	BONNET ASSY	157.53	185.10
BKA38068	BONNET ASSY	63.83	75.00
BKA41012	BONNET ASSY	63.83	75.00
BKA450050	BONNET ASSY	227.94	267.83
BKA450080	BONNET ASSY	351.19	412.65
BKA450080P	BONNET-ROVER 25(PATTERN)	147.23	173.00
BKA460070	BONNET ASSY	354.03	415.99
BKA500130	BONNET ASSY	427.63	502.47
BKB460040	HINGE ASSY-BONNET	23.87	28.05
BKB460050	HINGE ASSY-BONNET	23.87	28.05
BKD100141	STAY-BONNET	26.23	30.82
BKG38001	CLIP-BONNET STAY	2.30	2.70
BMB460020	HINGE ASSY-TRUNK LID	55.98	65.78
BMB460030	HINGE ASSY-TRUNK LID	59.05	69.38
BMB460080	HINGE ASSY-TRUNK LID	41.86	49.19
BMB460090	HINGE ASSY-TRUNK LID	43.09	50.63
BMD36001	TRUNK LID-ASSY	242.65	285.11
BMD37002	BOOT LID >91 R800	42.55	50.00
BMD38029	TRUNK LID ASSY 4 DOOR	63.83	75.00
BMD38031	TRUNK LID ASSY	63.83	75.00
BMD38035	TRUNK LID ASSY (200 COUPE)	80.85	95.00
BMD410040	TRUNK LID ASSY	63.83	75.00
BMD460010	TRUNK LID ASSY	378.68	444.95
BMD460050	TRUNK LID ASSY	395.73	464.98
BMD460070	TRUNK LID ASSY	507.59	596.42
BMD500100	TRUNK LID ASSY. MGTZ JAPAN	ENQUIRE	
BMI460011	STOP-TRUNK LID-HINGE	1.89	2.22
BMK192EVA	SLAVE CYLINDER-CLUTCH	52.49	61.68
BMK192EVA	CLUTCH SLAVE CYLINDER MGB	28.94	34.00
BMP124P	FINISHER-SEAM-RHR	11.49	13.50
BMP125P	FINISHER-SEAM-LHR	11.49	13.50
BMP339	USE BMD36001 & CKE10018 (SEAL)		
BMP454	FENDER-FRONT RH	83.97	98.66
BMP454P	RHF WING(PATTERN)	34.47	40.50
BMP455	FENDER-FRONT LH	83.97	98.66
BMP455P	LHF WING(PATTERN)		

CAM1717-DA608054

Part Number	Description	Price £ Ex VAT	Price £ Inc VAT
CAM1717	EXHAUST VALVE MGB'67>	4.95	5.82
CAM4255SLP	PUMP-WATER	19.99	23.49
CAM4255SLPP	WATER PUMP MINI (WITH BYPASS)	16.60	19.51
CAM4256EVA	PUMP-WATER	16.62	19.53
CAM4256SLP	PUMP-WATER	16.40	19.27
CAM4256SLPP	PUMP-WATER	15.53	18.25
CAM5231EVA	BELT-DRIVE-TIMING	13.01	15.29
CAM5331	ADAPTOR-OIL FILTER	11.53	13.55
CAM5430	USE GLP109		
CAM6822	USE LDR10074		
CAM9006EVA	BELT-DRIVE-TIMING	3.93	4.62
CAM9006EVA	BELT-DRIVE-TIMING	5.32	6.25
CAN10005	CLIP	29.08	34.17
CAN100130	CARRIER ASSY-R/RACK		ENQUIRE
CAN100140	CARRIER-SKI- R/RACK	42.55	50.00
CAN100170	CARRIER-CYCLE-R/RACK	75.00	88.13
CAP105290	KIT-ROOF RACK	12.50	14.69
CAR10002	STRAP-ROOF RACK LASHING	6.27	7.37
CAR10003	STRAP-LASHING-R/RACK	6.49	7.63
CAS000260PML	MUDFLAPS FRONT		ENQUIRE
CAS000290LNF	MUDFLAPS-KIT FRONT	18.92	22.23
CAS100270PMA	MUDFLAPS	14.97	17.59
CAS10040LOG	KIT-MUDFLAPS FRONT GREY	4.25	4.99
CAS10040PML	KIT-MUDFLAPS		ENQUIRE
CAS100570PMD	KIT-MUDFLAPS		ENQUIRE
CAS100680LPU	KIT-MUDFLAPS	21.91	23.28
CAS100690PML	KIT-MUDFLAPS	29.86	26.98
CAS100730PMA	KIT-MUDFLAP-FRONT	23.77	27.93
CAS100780PMD	MUDFLAP-FRONT		ENQUIRE
CAT000320PML	MUDFLAPS-KIT REAR	28.56	33.56
CAT000380LNF	MUDFLAPS-KIT REAR	8.47	9.95
CAT10042	KIT-CAR SET MUDFLAPS		ENQUIRE
CAT10044	KIT-MUDFLAPS	25.11	29.50
CAT100540PMA	MUDFLAPS	9.28	10.90
CAT100550LOG	MUDFLAPS REAR	6.59	7.74
CAT100550PMD	MUDFLAPS REAR	8.51	10.00
CAT100660LOG	KIT-MUDFLAPS	4.26	5.01
CAT100740LPU	KIT-MUDFLAPS		ENQUIRE
CAT100750LPU	MUDFLAP-REAR	22.68	26.65
CAT100820PML	KIT-MUDFLAPS	20.32	23.88
CAT100860PMA	KIT-MUDFLAPS	22.74	26.72
CAT100861PMA	MUDFLAPS-KIT REAR		ENQUIRE
CAT100870	KIT-MUDFLAPS	28.08	32.99
CAT100920PMD	MUDFLAP-REAR	8.84	10.39
CAT101190PMA	MUDFLAPS REAR	19.17	23.23
CAT101220LPU	MUDFLAPS REAR	9.15	10.75
CAT101230LPU	MUDFLAPS REAR	10.01	11.76
CAT101310PMA	KIT-MUDFLAPS	18.23	21.42
CAT101311PMA	MUDFLAPS-KIT REAR		ENQUIRE
CAX100170	BRACKET-ROOF RAIL MOUNTING	7.50	8.81
CDB100190	WEATHERSTRIP-B/LIGHT	56.78	66.72
CDP1141	BOOT LID - MONTEGO	85.11	100.00
CDP1885	WING-FRONT-LH	42.55	50.00
CDP1887	LH SILL PANEL		ENQUIRE
CDP2302	TAILGATE ASSY MONTEGO ESTATE	106.38	125.00
CDP6343	REGULATOR DOOR LHF.	34.04	40.00
CDU1490	USE CDU1490SLP		ENQUIRE
CDU1490P	SWITCH-RADIATOR THERMOSTAT		ENQUIRE
CDU1490SLP	SWITCH-RADIATOR THERMOSTAT	22.27	26.17
CDU1890EVA	GASKET-SUMP		ENQUIRE
CDU1997	RADIATOR	106.25	124.84
CDU1997P	USE PCC10006EVA		ENQUIRE
CDU2206	O RING-OIL PIPE		ENQUIRE
CDU2330EVA	KIT-REPAIR CLUTCH SLAVE CYLINDER	8.24	9.68
CDU2330EVA	KIT-REPAIR CLUTCH SLAVE CYLINDER		ENQUIRE
CDU2749	BELT-ENGINE TIMING	28.31	33.26
CDU2749P	BELT-ENGINE TIMING	12.77	15.00
CDU2785	GLASS ASSY-MIRROR	4.25	4.99
CDU2786	GLASS ASSY-MIRROR	4.25	4.99
CDU2788	GLASS ASSY-MIRROR	4.25	4.99
CDU2791	GLASS ASSY-MIRROR	4.25	4.99
CDU2792	GLASS ASSY-MIRROR	4.25	4.99
CDU3022EVA	SHOE ASSY REAR BRAKE SYSTEM	34.02	39.97
CDU3022EVA	BRAKE SHOES	13.62	16.00
CDU3030EVA	PAD-BRAKE	22.72	26.70
CDU3030EVA GS	USE GBP281 GS		
CDU3030EVA	BRAKE PADS	8.08	9.49
CDU3269	BULB & HOLDER ASSY	3.21	3.77
CDU3270	HOLDER ASSY & BULBS	3.39	3.98
CDU3822	KIT-CALIPER SET-REAR BRAKE	46.62	54.78
CDU3823	KIT-DUST COVER	7.76	9.12
CDU3824	PISTON-CYL-RR BRAKE	25.80	30.32
CDU3858	O RING THERMOSTAT HOUSING PETROL	0.63	0.74
CDU4162	COLLAR-DISTANCE MANUAL TRANS	18.28	21.48
CDU4164	COLLAR-DISTANCE MANUAL TRANS	2.00	2.35
CDU4191EVA	USE URF00605EVA		
CDU4255EVA	USE URF00910EVA		
CDU66	BEARING-BALL	28.26	33.21
CDU68	BEARING-ROLLER	36.61	43.02
CDU70	SEAL-DUST	3.10	3.64
CDU71	SEAL-SELECTOR MECH	5.88	6.91
CDU78	BEARING-BALL	68.05	79.96
CDU84	O RING	1.59	1.87
CDU085	BEARING-BALL	32.64	38.35
CFE000110	SEAL-FRONT DOOR/HOODWELL REAR	109.99	129.24
CFE000981	SEAL-FRONT DOOR/HEADER FRONT	108.17	127.10
CFE103020	SEAL ASSY-FRONT DOOR CHEATER	68.39	80.36

WEB ORDER - YOU SHOP - WE DELIVER. www.rimmerbros.co.uk

Part Number	Description	Price £ Ex VAT	Price £ Inc VAT	Part Number	Description	Price £ Ex VAT	Price £ Inc VAT
CFE103030	SEAL ASSY-FRONT DOOR CHEATER	65.09	76.48				
CHA129	USE CHA129P						
CHA129P	FRONT SPRING S+M 64-74	14.47	17.00				
CHA405	USE CHA405P						
CHA405P	ACCELERATOR CABLE MIDGET 1500	5.32	6.25				
CHA475	USE CHA475						
CHA493	USE CHA493P						
CHA493P	REAR SPRING MIDGET 1500	42.13	49.50				
CHA570	USE CHA570P						
CHA570P	FRONT SPRING M1500'75>	15.96	18.75				
CHA65	LH.SUN VISOR MIDGET73-7	13.87	16.30				
CHA708	SUN VISOR PIVOT BRACKET	5.96	7.00				
CHA709	RH.SUN VISOR MIDGET77ON	13.87	16.30				
CHA710	LH.SUN VISOR MIDGET77ON	13.87	16.30				
CHM13	USE 121356						
CHM430	BUMPER-ASSY-REAR PRIMED	42.55	50.00				
CHM431	BUMPER ASSY-FRONT MAESTRO	42.55	50.00				
CHM432	BUMPER ASSY-REAR	65.22	76.63				
CJE100431	SEAL-TRUNK LID	32.05	37.66				
CJE100450	SEAL-TRUNK LID	11.76	13.82				
CJM000060	BUFFER-BONNET	2.15	2.53				
CK12	FRONT SPAX CONVERSION KIT-MGB	238.26	279.96				
CK22	REAR SPAX CONV KIT MGA/MGB/MGC	127.62	149.95				
CK5	SPAX REAR CONV.SPRT/MIDGET.1959-64	184.64	216.95				
CK6	SPAX REAR CONV.SPRT/MIDGET.1964-75	184.64	216.95				
CK7	SPAX REAR CONV.SPRT/MIDGET.1975 ON	184.64	216.95				
CKE10018	SEAL-TRUNK LID	18.59	21.84				
CKE100760	SEAL-TAILGATE	12.72	14.95				
CKE100820	SEAL-TRUNK LID	43.08	50.62				
CKP7058EVA	KIT-HUB BEARING	45.48	53.44				
CLB10002	PROTECTOR-W/ARCH	9.77	11.48				
CLF000360	LINER-FRONT WHEELARCH	47.37	55.66				
CLF000370	LINER-FRONT WHEELARCH	47.37	55.66				
CLF000480	LINER-FRONT WHEELARCH	48.55	57.05				
CLF000490	LINER-FRONT WHEELARCH	48.55	57.05				
CLF000500	LINER-REAR WHEELARCH	24.74	29.07				
CLF000510	LINER-REAR WHEELARCH	24.74	29.07				
CLF000660	LINER-REAR WHEELARCH	22.21	26.10				
CLF000670	LINER-REAR WHEELARCH	22.20	26.09				
CLF100861	LINER-WHEELARCH	31.56	37.08				
CLF100871	LINER-WHEELARCH	31.56	37.08				
CLP2879	SEMS UNIT	0.36	0.42				
CLP3303EVA	GASKET EXHAUST SYSTEM	1.48	1.74				
CLP3303EVA	GASKET EXHAUST SYSTEM	0.59	0.69				
CLP5229	SCREW-WASHER	0.86	1.01				
CLP6458	STRIKER-TRUNK LID	4.01	4.71				
CLP7352	PIN-CABLE TO CALIPER HANDBRAKE	0.67	0.79				
CMB000350SLP	GLASS ASSY-WSCREEN	291.45	342.45				
CMB000370SLP	GLASS ASSY-GREEN SHADEBAND	251.96	296.05				
CMB000610	GLASS	251.96	296.05				
CMB10022	GLASS-WINDSCREEN	256.00	300.80				
CMB10022P	WINDSCREEN-BRONZE/BRONZE	98.72	116.00				
CMB10024	WINDSCREEN-GREEN TINT	42.55	50.00				
CMC10007	SUPPORT-WINDSCREEN GLAZING	4.53	5.32				
CN100169	CLIP-HOSE	1.19	1.40				
CN100208	USE GHC608						
CN100708A	CLIP	1.46	1.72				
CN100808	CLIP	1.66	1.95				
CND000010	SPORTBOX-ROOF RACK		ENQUIRE				
CONS2145	BLADE FUSE TESTER	4.65	5.46				
CONS2149	ADD-A-CIRCUIT FUSE/TAP / FUSE HOLDER	10.67	12.54				
CONS2235	BATTERY ACID TESTER	5.80	6.82				
CONS2406	TORCH/FLASHLIGHT (90MM LENS)	2.57	3.02				
CONS5220	DISPOSABLE WHITE OVERALLS LARGE	6.59	7.74				
CQB000520	FRAME ASSY	473.66	556.55				
CQB000520P	FRAME ASSY-TAILGATE GLASS	263.83	310.00				
QBB101190	GLASS-GREEN BACKLIGHT	281.03	330.21				
CRB001080PMA	MIRROR ASSY-EXTERIOR	120.06	141.07				
CRB002090PMA	MIRROR ASSY-REMOTE CONTROL EXT	120.06	141.07				
CRB10163	MIRROR ASSY	21.27	24.99				
CRB106140C0F	MIRROR ASSY-EXT RHD MANUAL RED	17.02	20.00				
CRB106220C0Q	MIRROR ASSY-ELEC CONTROL EXTO	21.27	24.99				
CRB106220MNS	MIRROR ASSY-ELEC CONTROL EXT *RH*	21.27	24.99				
CRB106270UME	MIRROR ASSY-ELEC CONTROL EXT *LH*	21.27	24.99				
CRB106300HNA	MIRROR ASSY-EXTERIOR	17.02	20.00				
CRB106460	MIRROR-REMOTE C/TROL	17.02	20.00				
CRB106510	MIRROR-REMOTE C/TROL	17.02	20.00				
CRB107680HAM	MIRROR ASSY-EXTERIOR	103.22	121.28				
CRB107680HFF	MIRROR ASSY-EXTERIOR	103.22	121.28				
CRB107680HYF	MIRROR ASSY-EXTERIOR	99.25	116.62				
CRB107680LML	MIRROR ASSY-EXTERIOR (F/T LH)	120.68	141.80				
CRB107680PAK	USE CRB107680LML						
CRB108270	MIRROR-TOWING	11.61	13.64				
CRB108320EAC	DOOR MIRROR.RHD.RH.MANUAL-VOLCANO		ENQUIRE				
CRB108340	MIRROR ASSY-EXTERIOR	21.06	24.75				
CRB108340P	RH DOOR MIRROR ASSY. MINI(FLAT)	19.95	23.44				
CRB108350	MIRROR ASSY-EXTERIOR	21.06	24.75				
CRB108350P	LH DOOR MIRROR ASSY. MINI(FLAT)	19.95	23.44				
CRB110160CMU	MIRROR ASSY-ELEC CONTROL EXT	127.04	149.27				
CRB110160JFM	USE CRB110160LML						
CRB110160LML	MIRROR ASSY-ELEC CONTROL EXT	140.72	165.35				
CRB110160PBT	MIRROR ASSY-ELEC CONTROL EXT	147.76	173.62				
CRB110170CDX	MIRROR ASSY-ELEC CONTROL EXT	99.13	116.48				
CRB110170FAR	MIRROR ASSY-ELEC CONTROL EXT	29.78	34.99				
CRB110170GUF	MIRROR.LHD.LH.ELEC-SIENNA GOLD	21.28	25.00				
CRB110170JBH	MIRROR ASSY-ELEC CONTROL EXT	97.27	114.29				
CRB110170MNX	MIRROR ASSY-ELECC CONTROL EXT	130.22	153.01				
CRB110180LW	MIRROR ASSY-ELEC CONTROL EXT	127.04	149.27				
CRB110190CDX	MIRROR.LHD.RH.ELEC-COPPERLEAF	109.91	129.14				
CRB110190CMU	MIRROR ASSY-ELEC CONTROL EXTERIO	137.72	161.82				
CRB110190FAR	MIRROR ASSY-ELEC CONTROL EXTERIO	122.16	143.54				
CRB110190GUF	MIRROR ASSY-ELEC CONTROL EXTERIO	29.78	34.99				
CRB110190HFF	MIRROR ASSY-ELEC CONTROL EXTERIO	29.78	34.99				
CRB110190HFN	MIRROR ASSY-ELEC CONTROL EXTERIO	125.21	147.12				
CRB110190HQM	MIRROR ASSY-ELECC CONTROL EXTERIO	122.16	143.54				
CRB110190JBH	MIRROR ASSY-ELEC CONTROL EXTERIO	97.27	114.29				
CRB110190JFV	MIRROR ASSY-ELEC CONTROL EXTERIO	127.96	150.35				
CRB110190JRJ	MIRROR ASSY-ELEC CONTROL EXTERIO	29.78	34.99				
CRB110190LEF	MIRROR ASSY-ELEC CONTROL EXTERIO	131.48	154.49				
CRB110190LW	MIRROR ASSY-ELEC CONTROL EXTERIO	125.21	147.12				
CRB110190NXX	MIRROR ASSY-ELEC CONTROL EXTERIO	29.78	34.99				
CRB110190PBT	MIRROR ASSY-ELEC CONTROL EXTERIO	122.16	143.54				
CRB110200CAQ	MIRROR.RHD.RH.ELEC-NIGHTFIRE RED	21.28	25.00				
CRB110200GUF	MIRROR.RHD.RH.ELEC-SIENNA GOLD	21.28	25.00				
CRB110200HFN	MIRROR.RHD.RH.ELEC-ALUMINA GREEN	21.28	25.00				
CRB110200JFM	MIRROR.RHD.RH.ELE-ROYAL BLUE		ENQUIRE				
CRB110200NXX	MIRROR.RHD.RH.ELEC-OLD ENG.WHITE	21.28	25.00				
CRC100190MMM	PAIR-CHROME MIRROR COVER 75	68.75	80.78				
CRC100960MMM	COVER ASSY-EX MIRROR	28.88	33.93				
CRC5329	USE KKF100390						
CRC6732EVA	EXHAUST-REAR ASSY	19.91	23.39				
CRC7603EVA	DOWNPIPE ASSY EXHAUST SYSTEM	26.97	31.69				
CRC7614EVA	EXHAUST-INTERMEDIATE	20.23	23.77				
CRC7785EVA	EXHAUST-INTERMEDIATE	59.03	69.36				
CRC7789EVA	EXHAUST-REAR ASSY	14.89	17.50				
CRC9287	HOSE-FUEL-PIPE		ENQUIRE				
CRC9295	TANK ASSY-FUEL		ENQUIRE				
CRC9531EVA	EXHAUST-INTERMEDIATE	14.89	17.50				
CRC9531EVA	USE WCE10148EVA						
CRC9532EVA	EXHAUST-REAR ASSY		ENQUIRE				
CRC9534EVA	EXHAUST-INTERMEDIATE	34.96	41.08				
CRC9534EVA	USE WCE10148EVA						
CRC9537EVA	EXHAUST-INTERMEDIATE	34.69	40.76				
CRD100360	GLASS ASSY-HTD-MIR	31.00	36.43				
CRD100370	GLASS ASSY-HTD-MIR	31.00	36.43				
CRK254	CARB.REBUILD KIT HS4(2 CARBS)	57.02	67.00				
CRK269	CARB.REBUILD KIT MG METRO TURBO	38.72	45.50				
CSA4002	CARPET SET BLACK (ROADSTER)	198.22	232.91				
CSE100050	COVER ASSY-EXTERIOR MIRROR ASSY	5.20	6.11				
CSTR640	TOWER MOUNT KIT-MINI ALLOY	20.00	23.50				
CSTR642	FRT.S/FRAME RR.MOUNTINGS ALLOY (PR)	26.38	31.00				
CTB100100	MIRROR ASSY-INTERIOR	46.59	54.74				
CUB000220	GLASS ASSY-FRONT DOOR GREEN RH.	34.04	40.00				
CUB000440	GLASS	149.44	175.59				
CUB000450	GLASS ASSY-FRONT DOOR TINTED	149.44	175.59				
CUB102440	GLASS ASSY-FRONT DOOR GREEN	34.04	40.00				
CUD1051	CARB.NEEDLE 'ACD'	5.11	6.00				
CUH000400	OE*WINDOW REGULATOR RH - MGF/MGT/159.95	187.94	187.94				
CUH000410	OE*WINDOW REGULATOR LH - MGF/MGT/159.95	187.94	187.94				
CUH10070	REGULATOR-ELEC-GLASS RH FRONT	21.27	24.99				
CUH10123	REGULATOR-FRONT DOOR LH MANUAL RHD	21.27	24.99				
CUH10124	REGULATOR						

Part Number	Description	Price £ Ex VAT	Price £ Inc VAT
DAB000160	BADGE ASSY-MG	14.90	17.51
DAB101360	USE DAB101710		
DAB101370	BADGE ASSY-MG	22.60	26.56
DAB101710	BADGE ASSY-MG	19.85	23.32
DAB101720	BADGE ASSY-MG	31.41	36.91
DAG000070M	BADGE-MG	12.43	14.61
DAG000080M	BADGE ASSY-REAR	ENQUIRE	
DAG000130M	BADGE-MG	ENQUIRE	
DAG100420	BADGE-MG	ENQUIRE	
DAH000060M	BADGE ASSY-REAR	19.80	23.27
DAH10036	USE DAH10036SLP		
DAH100590M	BADGE-MODEL-MINI	57.28	67.30
DAH100590M	BADGE-MINI BOOT(GREEN/CHROME)	13.40	15.75
DAM100690M	BADGE-GB	27.95	32.84
DAM100690M	'GB' STICK-ON CHROME	10.68	12.55
DAM100760H	BADGE	80.26	94.31
DAM5968	FLYWHEEL ASSY	ENQUIRE	
DAM7857	SCREW-FLANGED HEAD	0.44	0.52
DAT000170M	BADGE ASSY-REAR	ENQUIRE	
DAT000180M	BADGE ASSY-REAR TF 160	ENQUIRE	
DBM523	PLATE-OIL GUIDE	4.12	4.84
DBM588	USE DBM588L		
DBM588L	OE*BOLT	0.92	1.08
DBM589	WASHER-SPRING	0.40	0.47
DBM598	SHAFT-REVERSE IDLER	22.66	26.63
DBM599	GEAR-3RD-DRIVEN	92.75	108.98
DBM603	GEAR-4TH-DRIVEN	92.66	108.88
DBM612	GEAR-5TH-MAIN SHAFT	97.83	114.95
DBM619	SHAFT-COUNTER-TRANS	83.30	97.88
DBM620	SHAFT-COUNTER-TRANS	89.33	104.96
DBM633	GEAR-1ST CNTRSHT	12.68	14.90
DBM638	GEAR-2ND-CNTRSHT	13.46	15.82
DBM643	GEAR-5TH-CNTRSHT	16.80	19.74
DBM646	GEAR-3RD-CNTRSHT	ENQUIRE	
DBM651	GEAR-4TH-CNTRSHT	50.95	59.87
DBM658	WASHER	3.55	4.17
DBM659	WASHER	3.60	4.23
DBM660	WASHER	3.60	4.23
DBM661	WASHER	0.67	0.79
DBM662	WASHER	0.67	0.79
DBM663	WASHER-SPRING	4.26	5.01
DBM664	NUT-HEXAGONAL	6.59	7.74
DBM665	RING-SNAP	2.85	3.35
DBM684	ROD-CHANGE-MANUAL	15.00	17.63
DBM688	SPRING-DETENT-MANUAL	0.72	0.85
DBM689	SCREW	1.76	2.07
DBM690	BOLT-SPECIAL	0.28	0.33
DBM692	BOLT	0.74	0.87
DBM709	GEAR-DIFFERENTIAL	43.38	50.97
DBM731	WASHER-THRUST	0.69	0.81
DBM732	WASHER-THRUST	3.45	4.05
DBM733	WASHER-THRUST	0.57	0.67
DBM734	WASHER-THRUST	3.45	4.05
DBM735	WASHER-THRUST	2.77	3.25
DBM736	WASHER-THRUST	0.65	0.76
DBM737	WASHER-THRUST	2.77	3.25
DBM738	WASHER-THRUST	2.74	3.22
DBM739	WASHER-THRUST	2.15	2.53
DBM741	RING-SNAP	3.07	3.61
DBM742	RING-SNAP	3.91	4.59
DBM743	RING-SNAP	4.97	5.84
DBM744	RING-SNAP	1.11	1.30
DBM745	RING-SNAP	3.64	4.28
DBM746	RING-SNAP	3.64	4.28
DBM812EVA	SYNCHRONISER ASSY-1ST & 2ND COUNT	149.69	175.89
DBP1326	STRIKER-DOOR LOCK	8.03	9.44
DBP1420	BOLT-FLANGED HEAD	ENQUIRE	
DBP3067	NUT	1.37	1.61
DBP7047	PEDAL RUBBER CLUTCH/BRAKE	4.34	5.10
DBP7056	COVER	3.16	3.71
DBP7104	OE*REAR RUBBER HANGER EXH TO CHASSIS	1.62	1.90
DBP7241	EQUALIZER-HANDBRAKE	34.85	40.95
DBP7829	NUT-ALLOY-ROAD WHEEL	6.30	7.40
DCB10056	WINDSCREEN FINISHER RHD ROVER 800(RS)	ENQUIRE	
DCB100970P	FINISHER	77.99	91.64
DCD10218	FINISHER-BACKLIGHT RH COUPE	21.28	25.00
DCD10219	FINISHER-BACKLIGHT LH COUPE	21.28	25.00
DCP3625	NUT	1.35	1.59
DCP4229	SCRIVET	1.35	1.59
DCP4918	CAP-SPINDLE-WIPER	ENQUIRE	
DCP7354	MOUNTING-RUBBER	1.24	1.46
DCP7494EVA	JOINT-BALL-OUTER TRACK ROD	22.63	26.59
DCP7494EVA	TRACK ROD END RH	13.40	15.75
DCP7495EVA	JOINT-BALL-OUTER TRACK ROD	22.63	26.59
DCP7495EVA	TRACK ROD END LH	13.40	15.75
DCP8004	BULB HOLDER	ENQUIRE	
DCP9711EVA	FILTER ASSY-IN LINE FUEL LINES	18.63	21.89
DDC10070	FINISHER-FRONT DOOR RH	8.51	10.00
DDC10071	FINISHER-FRONT DOOR LH	8.51	10.00
DDC101800PMA	FINISHER ASSY-FR DR	24.75	29.08
DDC101810PMA	FINISHER ASSY-FR DR	24.75	29.08
DDD100500	FINISHER-B/C POST	12.51	14.70
DDD100510	FINISHER-B/C POST	12.51	14.70
DDE101440PMA	FINISHER ASSY-WAIST	23.34	27.42
DDE101450PMA	FINISHER ASSY-WAIST	23.34	27.42
DDJ000380	KIT-EXTERIOR TRIM	18.17	21.35
DDJ000390	KIT-EXTERIOR TRIM	18.17	21.35
DDJ000720LML	FINISHER-BODY SIDE SILL	73.79	86.70
DDJ000730LML	FINISHER-BODY SIDE SILL	73.79	86.70
DDJ100480M	FINISHER-BODY SIDE	20.42	23.99

Part Number	Description	Price £ Ex VAT	Price £ Inc VAT
DDJ101081LML	FINISHER-BODY SIDE SILL	121.03	142.21
DDJ101091LML	FINISHER-BODY SIDE SILL	109.50	128.66
DDQ000050	CLIP-SILL FINISHER RETAINING	2.62	3.08
DDQ100470	CLIP-FINISH-W/RAMP	2.56	3.01
DFB000010LML	SPOILER-FRONT BUMPER *TROPHY*	181.80	213.62
DFB100590LML	FRONT BIB SPOILER MG ZR MK1	93.61	109.99
DFD000020LML	SPOILER ASSY-TAILGATE-PRIMED	63.83	75.00
DFD000080LML	MGF TROPHY REAR BOOT SPOILER	ENQUIRE	
DFD000630LML	USE ZUA000510LML		
DFD10045	TAILGATE SPOILER	ENQUIRE	
DFD10083PML	TAILGATE SPOILER-BLACK	ENQUIRE	
DFD10089MNS	SPOILER ASSY-TRUNK QUICKSILVER	51.06	60.00
DFD10089PMF	SPOILER ASSY-TRUNK BLACK	51.06	60.00
DFD101110HNA	SPOILER-TAILGATE	63.83	75.00
DFD101110JRJ	SPOILER-TAILGATE	63.83	75.00
DFD101570LML	SPOILER-TRUNK	225.33	264.76
DFD101650GUF	TAILGATE SPOILER-SIENNA GOLD ROVER 25	ENQUIRE	
DFD101690LQW	BOOT SPOILER-ANTHRACITE	63.83	75.00
DFD106710LML	SPOILER-TRUNK	ENQUIRE	
DFT100820LML	KIT-FLARE-W/ARCH	374.41	439.93
DFT100820MLP	FLARED WHEEL ARCH KIT "SPORTSPAC"	73.19	86.00
DHB000050JAO	GRILLE ASSY-RADIATOR	88.44	103.92
DHB000050LZW	GRILLE ASSY-RADIATOR	139.56	163.98
DHB000050PBY	GRILLE ASSY-RADIATOR	98.27	115.47
DHB000050WRB	GRILLE ASSY-RADIATOR	93.43	109.78
DHB000060LZW	GRILLE ASSY-RADIATOR	139.56	163.98
DHB000360LES	GRILLE ASSY	90.78	106.67
DHB000390M	GRILLE ASSY-RADIATOR	168.23	197.67
DHB000440LML	GRILLE RADIATOR BEZEL	131.97	155.06
DHB000450LML	GRILLE RADIATOR BEZEL	74.98	88.10
DHB10119	GRILLE-RADIATOR	41.35	48.59
DHB10137	GRILLE-PRIMED-RAD	ENQUIRE	
DHB10150M	GRILLE ASSY-RADIATOR	92.40	108.57
DHB10150M	GRILLE ASSY-RADIATOR	56.29	66.14
DHB10150SLP	USE DHB10150M		
DHB10151M	GRILLE ASSY-RADIATOR	86.56	101.71
DHB101770M	GRILLE ASSY-RADIATOR	142.12	166.99
DHB101770M	GRILLE ASSY-RADIATOR	66.38	78.00
DHB101920M	GRILLE ASSY-RADIATOR	25.53	30.00
DHB101950M	GRILLE ASSY-RADIATOR	97.48	114.54
DHB102140M	GRILLE ASSY-RADIATOR	107.39	126.18
DHB102140SLP	GRILLE ASSY-RADIATOR	83.95	98.64
DHB102360MAR	GRILLE ASSY-RADIATOR	106.60	125.26
DHB102380M	GRILLE ASSY-RADIATOR	204.06	239.77
DHB102542M	GRILLE ASSY-RADIATOR	96.17	113.00
DHB102542M	GRILLE ASSY-RADIATOR(PLASTIC)	192.27	225.92
DHB102580M	GRILLE ASSY-RADIATOR	ENQUIRE	
DHB102690M	GRILLE ASSY-RADIATOR	199.53	234.45
DHB107720RHT	GRILLE ASSY-RADIATOR	160.96	189.13
DHF000080PMD	BEZEL ASSY-ENGINE INTAKE	60.00	70.50
DHF000090PMD	BEZEL ASSY-ENGINE INTAKE	60.00	70.50
DHF000100JRR	BEZEL ASSY-ENGINE INTAKE	27.65	32.49
DHF000100JZN	BEZEL ASSY-ENGINE INTAKE	ENQUIRE	
DHF000100LQY	BEZEL ASSY-ENGINE INTAKE	ENQUIRE	
DHF000100LZB	BEZEL ASSY-ENGINE INTAKE	27.65	32.49
DHF000100MAG	BEZEL ASSY-ENGINE INTAKE	27.65	32.49
DHF000100NUN	BEZEL ASSY-ENGINE INTAKE	26.21	30.80
DHF000100WAK	BEZEL ASSY-ENGINE INTAKE	27.65	32.49
DHF000100WAK	BEZEL ASSY-ENGINE INTAKE	ENQUIRE	
DHF000100WDM	BEZEL ASSY-ENGINE INTAKE	27.65	32.49
DHF000100WDQ	BEZEL ASSY-ENGINE INTAKE	20.69	24.31
DHF000100WDY	BEZEL ASSY-ENGINE INTAKE	20.69	24.31
DHF000100WFW	BEZEL ASSY-ENGINE INTAKE	18.73	22.01
DHF000110JRR	BEZEL ASSY-ENGINE INTAKE	27.65	32.49
DHF000110JZN	BEZEL ASSY-ENGINE INTAKE	21.30	25.03
DHF000110LQY	BEZEL ASSY-ENGINE INTAKE	27.65	32.49
DHF000110LZB	BEZEL ASSY-ENGINE INTAKE	27.65	32.49
DHF000110MAG	BEZEL ASSY-ENGINE INTAKE	34.55	40.60
DHF000110NUN	BEZEL ASSY-ENGINE INTAKE	27.72	32.57
DHF000110WAK	BEZEL ASSY-ENGINE INTAKE	26.21	30.80
DHF000110WAK	BEZEL ASSY-ENGINE INTAKE	22.32	26.23
DHF000110WDM	BEZEL ASSY-ENGINE INTAKE	27.65	32.49
DHF000110WDQ	BEZEL ASSY-ENGINE INTAKE	27.65	32.49
DHF000110WDY	BEZEL ASSY-ENGINE INTAKE	27.65	32.49
DHF000110WFW	BEZEL ASSY-ENGINE INTAKE	23.54	27.66
DHF000120HDQ	BEZEL ASSY-ENGINE INTAKE	27.66	32.50
DHF000120HQN	BEZEL ASSY-ENGINE INTAKE	9.95	11.69
DHF000120JAO	BEZEL ASSY-ENGINE INTAKE	29.18	34.29
DHF000120LDC	BEZEL ASSY-ENGINE INTAKE	29.18	34.29
DHF000120LZC	BEZEL ASSY-ENGINE INTAKE	27.66	32.49
DHF000120NUP	BEZEL ASSY-ENGINE INTAKE	29.18	34.29
DHF000120PBY	BEZEL ASSY-ENGINE INTAKE	27.66	32.50
DHF000120WAL	BEZEL ASSY-ENGINE INTAKE	32.72	38.45
DHF000120WAM	BEZEL ASSY-ENGINE INTAKE	29.18	34.29
DHF000120WBJ	BEZEL ASSY-ENGINE INTAKE	29.18	34.29
DHF000120WBN	BEZEL ASSY-ENGINE INTAKE	29.18	34.29
DHF000120WBP	BEZEL ASSY-ENGINE INTAKE	30.15	35.43
DHF000120WPJ	BEZEL ASSY-ENGINE INTAKE	9.95	11.69
DHF000120WRB	BEZEL ASSY-ENGINE INTAKE	9.95	11.69
DHF000130HDQ	BEZEL ASSY-ENGINE INTAKE	29.18	34.29
DHF000130HQN	BEZEL ASSY-ENGINE INTAKE	9.95	11.69
DHF000130JAO	BEZEL ASSY-ENGINE INTAKE	29.18	34.29
DHF000130LDC	BEZEL ASSY-ENGINE INTAKE	ENQUIRE	
DHF000130LZC	BEZEL ASSY-ENGINE INTAKE	9.95	11.69
DHF000130NUP	BEZEL ASSY-ENGINE INTAKE	9.95	11.69
DHF000130PBY	BEZEL ASSY-ENGINE INTAKE	27.66	32.50
DHF000130WAL	BEZEL ASSY-ENGINE INTAKE	30.15	35.43
DHF000130WAM	BEZEL ASSY-ENGINE INTAKE	29.18	34.29
DHF000130WBJ	BEZEL ASSY-ENGINE INTAKE	27.66	32.50

Part Number	Description	Price £ Ex VAT	Price £ Inc VAT
DHF000130WBN	BEZEL ASSY-ENGINE INTAKE	40.28	47.33
DHF000130WPB	BEZEL ASSY-ENGINE INTAKE	9.95	11.69
DHF000130WPJ	BEZEL ASSY-ENGINE INTAKE	9.95	11.69
DHF000130WRB	BEZEL ASSY-ENGINE INTAKE	27.66	32.50
DHF100080LML	BEZEL ASSY-ENGINE INTAKE	17.01	19.99
DHF100090LML	BEZEL ASSY-ENGINE INTAKE	17.01	19.99
DHF100300LZW	BEZEL ASSY-ENGINE INTAKE	35.73	41.98
DHF100310LZW	BEZEL ASSY-ENGINE INTAKE	37.01	43.49
DHN000060	DUCT-ENGINE INTAKE	8.07	9.48
DHN000070	DUCT-ENGINE INTAKE	5.80	6.82
DHN100100	DUCT-ENGINE INTAKE	5.80	6.82
DHN100110	DUCT-ENGINE INTAKE	5.80	6.82
DHS100020	RETAINER ASSY-DUCT	15.90	18.68
DHS100030	RETAINER ASSY-DUCT	6.38	7.50
DJB100260	PIN-PIVOT-HOOD FRAME	16.15	18.98
DJ0100010	EXTRUSION-CONVERTIBLE HOOD REAR BOW	85.68	100.67
DJP8473	RELAY	20.42	23.99
DJP8799	FUSE	0.34	0.40
DJP8800	FUSE	0.33	0.39
DJP8801	BLADE-FUSE-20 AMP	0.25	0.29
DJP8802	BLADE-FUSE-30 AMP	1.91	2.24
DJQ100080	CABLE-HOOD FRAME	19.59	23.02
DJY100010	LINK-ROD ASSY-HOOD	41.41	48.66
DKB001290EVA	ARM ASSY-WINDSCREEN WIPER	ENQUIRE	
DKB102030	ARM WINDSCREEN WIPER	26.86	31.56
DKB102040	ARM-PASSENGER WINDSCREEN WIPER	26.86	31.56
DKB102050	ARM WINDSCREEN WIPER	ENQUIRE	
DKB102060	ARM WINDSCREEN WIPER	ENQUIRE	
DKB102540	ARM WINDSCREEN WIPER	25.78	30.29
DKB102550	ARM WINDSCREEN WIPER	24.55	28.85
DKC000029SLP	BLADE-WIPER	8.43	9.91
DKC000029SLP	USE GWB711		
DKC000036SLP	BLADE-WIPER	7.58	8.91
DKC000041EVA	BLADE-WIPER	7.53	8.85
DKC000045SLP	BLADE-WIPER	7.80	9.17
DKC000048EVA	BLADE-WIPER	7.53	8.85
DKC000048SLP	USE DKC000048EVA		
DKC000051EVA	BLADE-WIPER	8.03	9.44
DKC000051SLP	USE DKC000051EVA		
DKC0000120	BLADE-BACKLIGHT WIPER	20.04	23.55
DKC0000190	BLADE-DRIVER WINDSCREEN WIPER	12.13	14.25
DKC0000190P	WIPER BLADE 20"	9.50	11.16
DKC0000331EVA	USE DKC0000331EVA		
DKC0000331EVA	BLADE-WIPER	9.36	11.00
DKC000055EVA	BLADE-WIPER	14.84	17.44
DKC10002	BLADE-WIPER	9.67	11.36
DKC10003	USE DKC101070		
DKC100660	BLADE-PASSENGER WINDSCREEN WIPER	11.86	13.

DPB102450LML-EDB000400LUM

Part Number	Description	Price £ Ex VAT	Price £ Inc VAT
DPB102450LML	BUMPER ASSY	211.32	248.30
DPB102460LML	BUMPER ASSY-FRONT	225.28	264.70
DPB102470LML	BUMPER ASSY	63.83	75.00
DPB102480LML	BUMPER ASSY	201.49	236.75
DPB102640LML	BUMPER ASSY	208.54	245.03
DPB103060PMD	BUMPER ASSY-FRONT	217.32	318.80
DPB103090LPM	BUMPER ASSY-FRONT		ENQUIRE
DPB104290WAI	BUMPER ASSY-FRONT	571.06	671.00
DPC000060LML	USE DPC000061LML		
DPC000060LMLP	USE DPC000061LMLP		
DPC000061LML	COVER ASSY-FR BUMPER	274.46	322.49
DPC000061LMLP	COVER ASSY-FR BUMPER-PRIMED	209.36	246.00
DPC000250LML	BUMPER FRONT	217.57	255.64
DPC000251LML	BUMPER ASSY-PRIMED FRONT	219.21	257.57
DPC000270LML	COVER ASSY-FR BUMPER	501.31	589.04
DPC000360JBH	COVER-PAINTED FRONT BUMPER		ENQUIRE
DPC000360LML	COVER-PRIMED FRONT BUMPER	217.57	255.64
DPC000361LML	COVER-PAINTED FRONT BUMPER	219.21	257.57
DPC000480LML	USE DPC000770LML		
DPC000680LML	COVER-PAINTED FRONT BUMPER	217.57	255.64
DPC000681LML	COVER-PAINTED FRONT BUMPER	219.21	257.57
DPC000770LML	USE DPC000771LML		
DPC000771LML	COVER ASSY-PAINTED FRONT BUMPER	236.40	277.77
DPC001120LZT	USE DPC001120LZY		
DPC001120LZY	COVER	323.66	380.30
DPC001200LML	BUMPER ASSY-PRIMED FRONT	229.85	270.07
DPC001201LML	BUMPER ASSY-PRIMED FRONT	229.85	270.07
DPC001220LML	BUMPER ASSY-PRIMED FRONT	229.85	270.07
DPC001230LML	BUMPER ASSY-PRIMED FRONT		
	MGZS 05/04>H/L POWWAS		ENQUIRE
DPC001280LML	COVER ASSY	474.97	558.09
DPC10050LML	COVER ASSY-FR BUMPER METRO	29.79	35.00
DPC101050LML	COVER-FRONT BUMPER	161.83	190.15
DPC101051LML	COVER-PRIMED FRONT BUMPER	161.83	190.15
DPC101330LML	COVER-FRONT BUMPER	172.11	202.23
DPC101331LML	COVER-PRIMED FRONT BUMPER	231.19	271.65
DPC101450LML	COVER-FRONT BUMPER	318.81	374.60
DPC101490LML	COVER-PRIMED FRONT BUMPER	183.90	216.08
DPC101520LML	COVER-FRONT BUMPER	179.49	210.90
DPE100430	ARMATURE ASSY-BUMPER	137.11	161.10
DPE100431	ARMATURE-FRONT BUMPER	137.11	161.10
DPF000160LML	USE DPF000200PMD		
DPF000170LML	USE DPF000210PMD		
DPF000200PMD	PANEL-FOG LAMP BLANKING	5.66	6.65
DPF000210PMD	PANEL-FOG LAMP BLANKING	5.66	6.65
DPL000180	BRACKET-FRONT BUMPER FOG MOUNTING	16.13	18.95
DPL000190	BRACKET-FRONT BUMPER FOG MOUNTING	16.13	18.95
DQB000960LML	USE DQB000961LML		
DQB000961LML	COVER ASSY-PRIMED REAR BUMPER	250.01	293.76
DQB001720LML	USE DQB001721LML		
DQB001721LML	BUMPER ASSY-PRIMED	221.90	260.73
DQB001750LML	USE DQB001720LML		
DQB001770LML	BUMPER ASSY-PRIMED REAR		ENQUIRE
DQB001780LML	USE DQB001781LML		
DQB001781LML	BUMPER ASSY-PRIMED REAR	221.89	260.72
DQB001810LML	BUMPER ASSY-PRIMED REAR	206.54	242.68
DQB001820LML	BUMPER ASSY-PRIMED REAR		ENQUIRE
DQB001830LML	BUMPER ASSY-PRIMED REAR	106.38	125.00
DQB10040LML	BUMPER	208.95	245.52
DQB10088PMD	BUMPER ASSY-REAR	230.21	270.50
DQB10094LPL	BUMPER ASSY-REAR	199.00	233.83
DQB10104LPL	BUMPER ASSY-REAR	205.97	242.01
DQB10117LML	BUMPER	208.95	245.52
DQB10118LML	BUMPER	215.95	253.74
DQB10157PMD	BUMPER ASSY-REAR	381.72	448.52
DQB101910LPM	BUMPER ASSY-REAR	42.55	50.00
DQB101920LPM	BUMPER ASSY-SELF COLOUR REAR		ENQUIRE
DQB102020	BUMPER ASSY-REAR	63.83	75.00
DQB102030	BUMPER ASSY-REAR R400 SAL.PET. 92>	230.21	270.50
DQB102080	BUMPER ASSY-REAR		ENQUIRE
DQB102090	BUMPER ASSY-REAR		ENQUIRE
DQB102410WAI	BUMPER ASSY-REAR	80.85	95.00
DQB102480LML-R1	USE DQB102481LML		
DQB102490LML	USE DQB102490LML-R1		
DQB102490LML-R1	USE DQB102491LML		
DQB102491LML	BUMPER ASSY-PRIMED REAR	177.54	208.61
DQC000040GMN	COVER ASSY-RR BUMPER PAINTED	209.36	246.00
DQC000040JFM	COVER ASSY-RR BUMPER PAINTED (ROYAL BLUE)		ENQUIRE
DQC000040LML	USE DQC000041LML		
DQC000041LML	COVER ASSY-RR BUMPER	230.37	270.68
DQC000140LML	USE DQB102490LML		
DQC000190LML	USE DQC000191LML		
DQC000191LML	BUMPER ASSY-PRIMED REAR	177.38	208.42
DQC000530LML	USE DQC000530LML-R1		
DQC000530LML-R1	COVER-PRIMED REAR BUMPER	206.00	242.05
DQC000540LML	USE DQC000530LML		
DQC000550LML	USE DQC000530LML-R1		
DQC001010	COVER ASSY-BLACK REAR BUMPER	208.51	245.00
DQC001010LML	COVER ASSY-PRIMED REAR BUMPER	230.37	270.68
DQC001030LML	COVER ASSY-PRIMED REAR BUMPER	230.37	270.68
DQC001540LML	COVER-PAINTED REAR BUMPER	206.00	242.05
DQC10036LML	COVER ASSY-RR BUMPER METRO 84>91 B80000>	29.79	35.00
DQC10050LML	USE DPC10050LML		
DQC100940LML	COVER-REAR BUMPER	160.61	188.72
DQC100941LML	COVER-PRIMED FRONT BUMPER	156.35	183.71
DQC101040LML	COVER-REAR BUMPER	213.22	250.53

WEB ORDER - YOU SHOP - WE DELIVER. www.rimmerbros.co.uk

Part Number	Description	Price £ Ex VAT	Price £ Inc VAT
DQC101150LML	COVER ASSY-RR BUMPER	377.31	443.34
DQC101210LML	COVER-REAR BUMPER	159.95	187.94
DQC101211LML	COVER-REAR BUMPER	156.35	183.71
DQC101350LML	USE DQC101040LML		
DQC101480LML	COVER-REAR BUMPER	179.49	210.90
DQC101530LML	USE DQC101531LML		
DQC101531LML	COVER ASSY-RR BUMPER	239.59	281.52
DQM000160	END CAP-RH	25.20	29.61
DQM000170	END CAP-LH	25.20	29.61
DQY000100PMD	GRILLE-FRONT BUMPER LOWER	48.03	56.44
DQY000110MMD	GRILLE-FRONT BUMPER LOWER	48.03	56.44
DQY000120PMD	GRILLE-REAR BUMPER	39.36	46.25
DQY000130MMD	GRILLE-REAR BUMPER	60.29	70.84
DQY000290PMD	GRILLE ASSY	19.46	22.87
DQY000300PMD	GRILLE ASSY	15.35	18.04
DQY000310PMD	GRILLE ASSY	13.49	15.85
DQY100200PMD	GRILLE-UPPER	33.40	39.25
DQY100210PMD	GRILLE-FRONT BUMPER	30.81	36.20
DQY100250	GRILLE-FRONT BUMPER	48.69	57.21
DQY100250P	GRILLE-FRONT BUMPER (PLASTIC)	19.79	23.25
DQY100390MMD	GRILLE-UPPER	38.42	45.14
DQY100400MMD	GRILLE-FRONT BUMPER	49.13	57.73
DQY100500MMD	GRILLE-UPPER	79.29	93.17
DQY100510MMD	GRILLE-FRONT BUMPER	83.07	97.61
DRC1382	IGNITION SWITCH (COL-LOCK) 76-80	15.11	17.75
DRC8626EVA	FLASHER UNIT-ELECTRONIC	12.59	14.79
DSB000330CCV	HOOD ASSY	2615.80	3073.57
DSB000330H2P	HOOD ASSY	2615.80	3073.57
DSB000330J2P	HOOD ASSY	2615.80	3073.57
DSB000330LFM	HOOD ASSY	2615.80	3073.57
DSB000330PDA	HOOD ASSY	2687.41	3157.71
DSB100220CCV	HOOD ASSY-MANUAL CONVERTIBLE	2598.45	3053.18
DSB100220CCV	HOOD ASSY-MANUAL CONVERTIBLE	1661.60	1952.38
DSB100220CCV-E	HOOD ASSY-MANUAL CONVERTIBLE	642.00	754.35
DSB100220H2P	USE DSB100220H2P-E		
DSB100220H2P-E	HOOD ASSY-MANUAL CONVERTIBLE SURCHARGE	642.00	754.35
DSB100220J2P	HOOD ASSY-MANUAL CONVERTIBLE	2626.44	3086.07
DSB100220J2P-E	HOOD ASSY-MANUAL CONVERTIBLE SURCHARGE	635.58	746.81
DSB100220J2P-E	HOOD ASSY-MANUAL CONVERTIBLE SURCHARGE	500.00	587.50
DSB100220J2P-E	HOOD ASSY-MANUAL CONVERTIBLE SURCHARGE	674.10	792.07
DSB100220L2D	USE DSB100220L2D-E		
DSB100220L2D-E	HOOD ASSY-MANUAL CONVERTIBLE SURCHARGE	642.00	754.35
DSB100220PDA	HOOD ASSY-MANUAL CONVERTIBLE	2945.70	3461.20
DSB100220PDA-E	HOOD ASSY-MANUAL CONVERTIBLE SURCHARGE	787.94	925.83
DSB100220RIN-E	HOOD ASSY-MANUAL CONVERTIBLE SURCHARGE	642.00	754.35
DSB100220SBT	USE DSB100220SBT-E		
DSB100220SBT-E	HOOD ASSY-MANUAL CONVERTIBLE SURCHARGE	642.00	754.35
DSDD000020	COVER-CONVERTIBLE HOOD	57.02	67.00
DSDD00020PMA	COVER-CONVERTIBLE HOOD		ENQUIRE
DSDD00030PMA	COVER		ENQUIRE
DSDD00060CCV	COVER ASSY-CONVERTIBLE HOOD	581.73	683.53
DSDD00060H2P	COVER ASSY-CONVERTIBLE HOOD	581.73	683.53
DSDD00060J2P	COVER ASSY-CONVERTIBLE HOOD	581.73	683.53
DSDD00060LFM	COVER ASSY-CONVERTIBLE HOOD	581.73	683.53
DSDD00060PDA	COVER ASSY-CONVERTIBLE HOOD	581.73	683.53
DSDD00070CCV	COVER ASSY-HOOD TONNEAU	231.87	272.45
DSDD00070LPR	COVER ASSY-HOOD TONNEAU	143.52	168.64
DSDD00070PMA	COVER ASSY-HOOD TONNEAU		ENQUIRE
DSDD00070PMA	USE DSD100590PMA		
DSDD00070SBA	COVER ASSY-HOOD TONNEAU	204.87	240.72
DSDD00080	COVER ASSY-HOOD	24.88	29.23
DSD100430H2P	COVER ASSY-HOOD	626.08	735.64
DSD100430J2P	COVER ASSY-HOOD	659.08	774.42
DSD100430L2D	COVER ASSY-HOOD (GREY)	336.17	395.00
DSD100450	COVER-CONV HOOD	36.28	42.63
DSD100590CCV	COVER ASSY-HOOD TONNEAU	224.75	264.08
DSD100590PMA	COVER ASSY-HOOD TONNEAU	129.36	152.00
DSD100590R10	COVER-TONNEAU	103.69	121.84
DSD100590R1V	COVER-TONNEAU	175.11	205.75
DSD100590SAV	COVER ASSY-HOOD TONNEAU	103.69	121.84
DSD100630PMA	COVER-TONNEAU	150.52	176.86
DSE00020PMA	FRAME ASSY-MANUAL HOOD	850.72	999.60
DSE100260PMA	FRAME ASSY-MANUAL HOOD		ENQUIRE
DSF101140PMD	SEAL ASSY-HARDTOP	10.95	12.87
DSF101200PMA	USE DSF101350PMA		
DSF101280PMD	SEAL ASSY-HARDTOP	65.53	77.00
DSF101300PMD	SEAL ASSY-HARDTOP	31.43	36.93
DSF101340PMA	SEAL ASSY-CONV HOOD	80.41	94.48
DSF101350PMA	SEAL ASSY-CONV HOOD	80.41	94.48
DSJ100490PMD	FINISHER-HARDTOP	25.69	30.19
DSL000030LFM	BACKLIGHT ASSY-HOOD GLAS	444.47	522.25
DSL000030PDA	BACKLIGHT ASSY-HOOD GLAS		ENQUIRE
DSL100100H2P	USE XPT000091HZP1		
DSL100100J2P	USE XPT000091JZP1		
DSL100100LFM	USE XPT000091LFM		
DSL100100L2D	USE XPT000091LZD1		
DSS100220PMD	STRIKER-HOOD FRONT HEADER		ENQUIRE
DSS100230PMD	STRIKER-HOOD FRONT HEADER	10.01	11.76
DTCC00050MBA	TRIM-CENTRE ROADWHEEL	16.56	19.46
DTCC00080LEH	TRIM-ROADWHEEL	12.81	15.05
DTCC100630LEH	TRIM-CENTRE ROADWHEEL		ENQUIRE
DTC100630MNH	CAP-WHEEL CENTRE-MGF	11.30	13.28
DTC100630MNV	TRIM-CENTRE ROADWHEEL	9.53	11.20
DTC100680MNH	TRIM-ROADWHEEL	14.59	17.14
DTC100690MNH	TRIM-ROADWHEEL	14.73	17.31
DUB000130	FINISHER-TRIM EXHAUST TAILPIPE	76.86	90.31
DUN100230	PLATE ASSY-CONVERTIBLE HOOD RETAININ	2.37	2.78

Part Number	Description	Price £ Ex VAT	Price £ Inc VAT
DUQ100020	TAPE-HOOD		ENQUIRE
DUQ100030	TAPE-HOOD	39.56	46.48
DXB100540	BEZEL-RH		ENQUIRE
DXB100550	BEZEL-LH		ENQUIRE
DXI100020	INSERT-CANOPY-HOOD	18.44	21.67
DXI100040	INSERT-CANOPY-HOOD	22.10	25.97
DXI100050	INSERT-CANOPY-HOOD	20.02	23.52
DXJ000020	DUCT-AIR COOLING-FRONT BUMPER	26.16	30.74
DXR100040	ZIP-BACKLIGHT-HOOD	77.36	90.90
DXS100070	KIT-HOOD FINISHER	96.74	113.67
DXU100020PMA	USE HMP118099AMB		
DXU100140PMA	USE HMP118099MGR		
DXW100140PMA	CATCH ASSY-REAR HOODWELL	4.29	5.04
DXW100200PMA	CATCH ASSY-CONV HOOD		ENQUIRE
DXW100280PMA	CATCH ASSY-CONV HOOD RH	56.76	66.69
DXW100290PMA	CATCH ASSY-CONV HOOD LH	56.76	66.69
DYF000200	WASHER-PLAIN-THICK	0.32	0.38
DYF100500	WASHER-PLAIN	9.72	11.42
DYF100510	WASHER-SEALING	10.14	11.91
DYG100580	BOLT-TORX-PAN	2.23	2.62
DYH100710	NUT-HEXAGONAL-THIN	7.66	9.00
DYH100780	NUT	2.99	3.51
DYM000020	CARTRIDGE-ADHESIVE		ENQUIRE
DYN000040	USE DYN000040L		
DYN000040L	TAPE	30.77	36.15
DYP10035L	OE-SCREW/WASHER-GRILLE	2.72	3.20
DYP10045L	SCREW-TORX-PAN	0.48	0.56
DYP101150	SCREW-PAN	1.55	1.82
DYP101350	SCREW-TORX	0.44	0.52
DYQ000100	RIVET-POP-STAINLESS STEEL	0.44	0.52
DYR100250	STUD	1.23	1.45
DYX000020	RING-SEALING	1.02	1.20
DZB100220SLP	SEAL	3.98	4.68
DZN10001	INSERT	0.57	0.67
EAD000010PMA	CARPET-HOODWELL	61.74	72.54
EAD000180PGT	CARPET-MAIN FLOOR	318.82	374.61
EAD000190PGT	CARPET-MAIN FLOOR	271.25	318.72
EAD101261PMA	CARPET-REAR BULKHEAD	4.99	5.86
EAD101272PMA	CARPET-HOODWELL		ENQUIRE
EAG000260LNF	CARPET ASSY-LOADSPACE	143.95	169.14
EAH000180LNF	CAR SET-DROP IN MAT	48.49	56.98
EAH000190LNF	CAR SET-DROP IN MAT	42.28	49.68
EAH000200PMA	MAT-FRONT FLOOR	16.56	19.46
EAH000230PMA	MAT-FRONT FLOOR	25.71	30.21
EAH000520PMA	MAT-REAR FLOOR DROP IN		

Part Number	Description	Price £ Ex VAT	Price £ Inc VAT
EDB102630LUM	HEADLINING ASSY-ROOF	193.96	227.90
EDG100170LNF	FINISHER-HEADLINING	10.87	12.77
EDG100170LUM	FINISHER-HEADLINING	10.14	11.91
EDP109EVA	SET-DISTRIBUTOR CONTACT	3.09	3.63
EDP3050EVA	USE URF009978EVA		
EDP3706EVA	DAMPER ASSY	24.25	28.49
EDP3842EVA	DAMPER REAR	144.88	170.23
EDP4412EVA	RHR SHOCK ABSORBER ROVER 820	81.70	96.00
EDP4413EVA	LHR SHOCK ABSORBER ROVER 820	81.70	96.00
EDP5642	SLUG-WINDSCREEN MIRROR FIXING	1.82	2.14
EDP7169P	USE ADU9549EVA		
EDP7418EVA	KIT-HUB BEARING	45.95	53.99
EDP7864	CLIP-SPRING-STEEL	1.66	1.95
EDQ103880LNF	SUNVISOR ASSY-FRONT HEADER	50.32	59.13
EDQ103880LUM	SUNVISOR ASSY-FRONT HEADER	45.53	53.50
EDQ103910LNF	SUNVISOR ASSY-FRONT HEADER	50.32	59.13
EDQ103910LUM	SUNVISOR ASSY-FRONT HEADER	ENQUIRE	
EDU1004	BOLT-FLANGED HEAD	0.76	0.89
EDU1082EVA	CARTRIDGE-OIL FILTER	7.46	8.77
EDU1203EVA	ROTOR HEAD ASSY-DISTRIBUTOR	7.24	8.51
EDU4776EVA	USE URF009978EVA		
EED10065	SUNROOF ASSY-GLASS	39.60	46.53
EED100930LNG	SUNROOF ASSY-GLASS	106.38	125.00
EFP191	SWITCH-HANDBRAKE	15.65	18.39
EFP279EVA	USE EEP279EVA		
EFP279EVA	SWITCH-OIL-PRESSURE	4.43	5.21
EFP9	AERIAL	8.51	10.00
EEQ10007	SEAL-SUNROOF	8.51	10.00
EFJ100180	SUN ROOF WIND DEFLECTOR	17.02	20.00
EFF6111EVA	DOWNSPIPE ASSY EXHAUST SYSTEM	52.48	61.66
EFF6111EVA	FRONT PIPE	40.42	47.49
EGP1254	BRAKE DISC-REAR*SINGLE*	32.26	37.91
EGP1254 ROS	PAIR ROSSINI PERFORMANCE DISCS REAR	99.56	116.98
EGP1254P	DISC-REAR BRAKE	15.30	17.98
EGP1254URC	EBC TURBO GROOVE BRAKE DISC *PAIR*	91.06	107.00
EGP1529	SPRING-COIL	2.24	2.63
EGP1617EVA	EXHAUST-REAR ASSY	47.59	55.92
EGP1649EVA	EXHAUST-INTERMEDIATE	ENQUIRE	
EGP1662	LINK ASSY ANTI-ROLL BAR	21.71	25.51
EGP1662P	LINK-R200/400	3.66	4.30
EGP1673	BUSH-LOWER ARM-SUSP	12.57	14.77
EGP1714	CLAMP	9.99	11.74
EJE100260PMA	PULL-DOOR	1.92	2.26
EJE100270PMA	PULL-DOOR	1.92	2.26
EJH000060MVK	INSERT ASSY-FRONT DOOR GARNISH	9.98	11.73
EJH000070MVK	INSERT ASSY-FRONT DOOR GARNISH	9.98	11.73
EJP1051	KNOB-TRIP RESET	0.30	0.35
EJP1180	BULB & HOLDER ASSY	2.83	3.33
EJP1380	BUSH	1.56	1.83
EJP1420	KIT-GUIDE PIN-CLPR	23.69	27.84
EJP1421	KIT-DUST COVER	13.13	15.43
EJP1437	BRAKE PAD KIT REAR	49.48	58.14
EJP1437GS	EBC GREENSTUFF KEVLAR BRAKE PADS	34.04	40.00
EJP1437P	KIT-PAD REAR CALIPERR200/400/25/45	12.77	15.00
EJP1446EVA	CYLINDER ASSY-BRAKE MASTER	ENQUIRE	
EJP1446EVA	CYLINDER ASSY-BRAKE MASTER	42.55	50.00
EJP1451	KIT-REPAIR BRAKE SERVO	16.09	18.91
EJP1488	CYLINDER-WHEEL-LH	44.07	51.78
EJP1488P	WHEEL CYLINDER	12.34	14.50
EJP1489	CYLINDER-WHEEL-RH	44.49	52.28
EJP1489P	WHEEL CYLINDER	12.34	14.50
EJP1504	O RING	1.81	2.13
EJP1506P	JOINT-CONSTANT VELOCITY	40.00	47.00
EJP1509	KIT-GAITER-INNER JOINT DRIVESHAFT	11.80	13.87
EJP1509P	CV BOOT KIT	8.21	9.65
EJP736EVA	DISC-BRAKE **EACH**	ENQUIRE	
EJP736EVA UR	EBC TURBO GROOVE BRAKE DISC *PAIR*	72.34	85.00
EJP736EVA	BRAKE DISC **PAIR**	22.34	26.25
EJP7738	NUT R380	1.79	2.10
EJP9579SLP	DISC-VENTED BRAKE **EACH**	24.76	29.09
EJP9579SLP UR	EBC TURBO GROOVE BRAKE DISC *PAIR*	114.89	135.00
EJP9579SLPP1	BRAKE DISC **PAIR** OEM	75.00	88.13
EJU100242	FINISHER-WAIST SEAL	27.87	32.75
EJU100252	FINISHER-WAIST SEAL	27.87	32.75
EJZ100320PMA	BUTTON/LINK-SILL-DR	ENQUIRE	
EJZ100330PMA	BUTTON/LINK-SILL-DR	1.51	1.77
EMB100620LNF	FINISHER-A POST UPPER	5.99	7.04
EMB100620LUM	FINISHER-A POST UPPER	5.99	7.04
EMB100630LNF	FINISHER-A POST UPPER	5.99	7.04
EMB100630LUM	FINISHER-A POST UPPER	ENQUIRE	
EMP7120EVA	CABLE-HANDBRAKE-RH	39.68	46.62
EMP7120EVA	BRAKE CABLE	34.69	40.76
EMP7331	USE EMP7331SLP		
EMP7331SLP	LINK ASSY ANTI-ROLL BAR	38.64	45.40
EMP7331SLPP	STABILIZER LINK	6.12	7.19
EMP7423EVA	DAMPER REAR	156.30	183.65
EMP7537EVA	CABLE-HANDBRAKE-LH	44.64	52.45
EMP7537EVA	BRAKE CABLE	39.95	46.94
EMP9109EVA	EXHAUST-INTERMEDIATE	17.02	20.00
EPB100900LNF	PARCEL SHELF ASSY-REAR END TRIM	17.02	20.00
EPU100190	SUNBLIND ASSY-REAR	38.67	45.44
EQN100010	SEAL-PASSENGER BULK HEAD	21.07	24.76
EQY100630LNF	FINISHER-BULKHEAD	29.93	35.17
EQY100660CVC	FINISHER-REAR BULKHEAD	253.82	298.24
EQY100660LPR	FINISHER-REAR BULKHEAD	294.58	346.13
EQY100660SAV	FINISHER-BULKHEAD	250.18	293.96
EQY100660SBA	FINISHER-REAR BULKHEAD	29.93	35.17
EQY100730LNF	FINISHER-BULKHEAD	268.40	315.37
ERC3256P	PLUG LEAD SET 4 CYL.	6.81	8.00
ERK100231	COVER-ENGINE	16.78	19.72

Part Number	Description	Price £ Ex VAT	Price £ Inc VAT
ERK100232	COVER-ENGINE	16.78	19.72
ERR4035	DISTRIBUTOR MGR V8 S.O.O	331.90	389.98
ERR5542	OE*OIL FILTER DIESEL	7.78	9.14
ERR5542P	OIL FILTER DIESEL	2.80	3.29
ERR597	SPECIAL NUT	1.28	1.50
ERR6380E	PUMP ASSY-FUEL INJ	865.65	1017.14
ERR6381	PUMP ASSY-FUEL INJ	973.64	1144.03
ESD000070PMA	BIN-LOADSPACE STOWAGE	ENQUIRE	
ESH10005	GUARD-DOG-LOADSPACE	8.51	10.00
ESH100182	GUARD ASSY ENGINE REAR APERTURE	39.75	46.71
ESK100260	KIT-TIDY NET-TRUNK	9.24	10.86
ESK100430	KIT-TIDY NET-TRUNK	ENQUIRE	
ESK100460K	KIT-SEAT BELT FIXG	1.33	1.56
ESK1005470	KIT-TIDY NET-TRUNK	ENQUIRE	
ESR2034	OE*NUT	1.32	1.55
ESR3806A	SEAL FUEL PUMP TO TANK	5.71	6.71
ESR4103	OE*AIR FILTER ELEMENT	12.14	14.26
ESR4103K-N	K&M AIR FILTER 1.8 P/2L TURBO DIESEL	25.49	29.95
ETC000410	PAD-INSULATION ENGINE BAY	16.74	19.67
ETC100672	PAD-INSULATION	10.19	11.97
ETC100830	PAD-FUEL BAY BULKHEAD INSULATION	12.09	14.21
ETC100840	PAD-INSULATION	28.56	33.56
ETC100850	PAD-INSULATION ENGINE BAY	ENQUIRE	
ETC107130	PAD-INSULATION ENGINE BAY	ENQUIRE	
ETC4765	OE*THERMOSTAT 88"	5.39	6.33
ETC4765P	THERMOSTAT 88"	3.34	3.92
ETL100202	PAD-FRONT FOOTWELL INSULATION	17.48	20.54
ETL100212	PAD-FRONT FOOTWELL INSULATION	17.44	20.49
ETQ100121	LOOR INSULATION	6.24	7.33
ETQ100080	PAD-TUNNEL INSULATION	2.23	2.62
ETR100090	PAD-TUNNEL INSULATION	2.28	2.68
ETU000050	PAD-REAR BULKHEAD INSULATION	16.14	18.96
ETU000070	PAD-HOODWELL INSULATION	41.96	49.30
ETU100150	PAD-INSULATION-RR	17.04	20.02
ETU100171	PAD-INSULATION	44.04	51.75
EUM10001	CLIP	0.84	0.99
EV8000660LNF	SEAT BELT ASSY-ACTIVE FRONT LONG END	125.77	147.78
EV810460LNF	SEAT BELT ASSY-FRONT	117.40	137.95
EV8104641LNF	SEAT BELT ASSY-ACTIVE FRONT SHORT EN	17.40	137.95
EV8104650LNF	SEAT BELT ASSY-FRONT	117.40	137.95
EV8104651LNF	SEAT BELT ASSY-ACTIVE FRONT SHORT EN	17.40	137.95
EYA10007	GROMMET	1.79	2.10
EYC10052	CLIP	1.56	1.83
EYC10061	CLIP	0.84	0.99
EYC10064	CLIP-SNAP SACK	0.84	0.99
EYC10066	CLIP	0.74	0.87
EYC101050	CLIP-TRIP RETENTION	0.31	0.36
EYG100160	BOLT	0.70	0.82
EYP10012	SCREW-SELF TAPPING	0.47	0.55
EYP10063	SCREW	0.51	0.60
EYP100870	SCREW-POLYIMATE	1.41	1.66
EYR000050	STUD-SHOULDER	3.11	3.65
EZM100320	OE*FASTENER	0.38	0.45
EZM100320A	USE EZM100320		
F3FBJ5428	BALL JOINT	13.85	16.27
F3FBJ5429	BALL JOINT	15.52	18.24
F3FBJ5430	BALL JOINT	15.52	18.24
F3FCA6188	WISHBONE	63.39	74.48
F3FCA6189	WISHBONE	63.39	74.48
F3FDL6609	STABILISER LINK	14.78	17.37
F3FDL6610	STABILISER LINK	13.44	15.79
F3FDL6611	STABILISER LINK	13.44	15.79
F3FFP1043	FUEL PUMP	82.82	97.31
F3FKB2550	BRAKE CABLE	24.90	29.26
F3FKB2551	BRAKE CABLE	24.88	29.23
F3FSK6418	BUSH	37.28	43.80
F3FSK6419	BUSH	37.28	43.80
F3FSK6420	BUSH	38.74	38.59
F3FTR5023	TIE ROD END	16.17	19.00
F3FTR5024	TIE ROD END	16.17	19.00
F3FTR5025	RACK END	16.91	19.87
F3FTS4582	THERMOSTAT	22.70	26.67
F3FWP1942	WATER PUMP	64.73	76.06
F3FWP2035	WATER PUMP	62.55	73.50
F3HK2065	CLUTCH KIT 3-IN-1	252.03	296.14
F3HK2728	CLUTCH KIT 2-IN-1	234.69	275.76
F3HK7289	USE RP1068		
F3HK7794	CLUTCH KIT 3-IN-1	94.27	110.77
F3HK7851	CLUTCH KIT 3-IN-1	317.26	372.78
F3HK9065	CLUTCH KIT 3-IN-1	83.73	98.38
F3HK9203	CLUTCH KIT 3-IN-1	110.42	129.74
F3HK9539	CLUTCH KIT 3-IN-1	122.30	143.70
F4CS1297	CAMSHAFT SENSOR	59.69	70.14
F4LB1891	LAMBDA SENSOR	61.05	71.13
FAB104800CVC	FACIA ASSY	846.62	994.78
FAB104800LNF	FACIA ASSY	ENQUIRE	
FAB104800LPR	FACIA ASSY	99.75	117.21
FAB104800SAV	FACIA ASSY	758.85	891.65
FAB104800SBA	FACIA ASSY	99.75	117.21
FAB104810CVC	FACIA ASSY	99.75	117.21
FAB104810LNF	FACIA ASSY	918.73	1079.51
FAB104810LPR	FACIA ASSY	758.85	891.65
FAB104810SAV	FACIA ASSY	769.81	904.53
FAB104810SBA	FACIA ASSY	756.27	887.44
FAM2903EVA	CABLE-HANDBRAKE	9.65	11.36
FAM2903EVA	BRAKE CABLE	4.78	5.62
FAM3903	CIRCLIP	0.84	0.99
FAM3968	CONE-SUSPENSION SPRING	35.32	41.50
FAM4752	CLAMP	7.90	9.28
FAM6240EVA	CABLE-HANDBRAKE	7.39	8.68

Part Number	Description	Price £ Ex VAT	Price £ Inc VAT
FAM6240EVA	BRAKE CABLE	3.39	3.98
FAM7789	COLLAR	3.47	4.08
FAM7821P	VALVE-BRAKE PRESSURE	79.95	93.94
FAM8419	STUD	4.68	5.50
FAM8560EVA	CABLE ASSY HANDBRAKE	10.51	12.35
FAM9252	USE NAM3620		
FAM9267	WASHER-SEALING	5.50	6.46
FAM9359EVA	CYLINDER ASSY-BRAKE MASTER	24.77	29.10
FAM9425	WASHER	2.12	2.49
FAM9425P	WASHER	0.64	0.75
FAM9525	MOUNTING-FRONT SUBFRAME RUBBER	18.51	21.75
FAM9525P	MOUNTING-FRONT SUBFRAME RUBBER	13.95	16.39
FB106067	USE FB106067L		
FB106067A	USE FB106067L		
FB106067L	BOLT	0.38	0.45
FB106071	BOLT	0.52	0.61
FB106075	BOLT-FLANGED HEAD	ENQUIRE	
FB106105	BOLT-FLANGED HEAD	0.94	1.10
FB106115	BOLT-FLANGED HEAD	0.52	0.61
FB108091	BOLT	1.52	1.79
FB108095	BOLT	0.92	1.08
FB110091	BOLT	3.91	4.59
FB110101	BOLT-FLANGED HEAD	1.62	1.90
FB110111	BOLT	0.94	1.10
FB110121P	BOLT	1.54	1.81
FB110131	BOLT-FLANGED HEAD	1.57	1.84
FB110141P	BOLT-FLANGED HEAD	0.47	0.55
FB110221	USE FB110221L		
FB110221L	OE*BOLT	1.98	2.33
FB112111	BOLT	1.64	1.93
FB112241	BOLT	4.29	5.04
FC108125	BOLT-FLANGED HEAD	1.26	1.48
FC108135	BOLT	1.18	1.39
FC112121	BOLT	1.36	1.60
FC112121P	BOLT	0.21	0.25
FC112161	BOLT-FLANGED HEAD	1.59	1.87
FC112171M	BOLT-FLANGED HEAD	2.58	3.03
FC112187A	BOLT-FLANGED HEAD	2.62	3.08
FDG100160	KIT-VENEER FACIA	ENQUIRE	
FDU1464EVA	BELT-ENGINE TIMING	26.00	30.55
FDU1464EVA	BELT-ENGINE TIMING	17.45	20.50
FDU1466	BELT-TIMING	37.40	43.95
FDU1466P	TIMING BELT	23.57	27.69
FDU1632EVA	ELEMENT AIR CLEANER	12.02	14.12
FDU1632EVA	AIR FILTER	9.95	11.69
FDU1762EVA	USE 2N3132		
FDU1817EVA	BELT-DRIVE-TIMING	5.44	6.39
FDU1817EVA	MULTI RIB BELT	4.75	5.58
FDU2522EVA	USE 2N3132		
FFB000420CVC	GLOVEBOX ASSY-FACIA	45.05	52.93
FFB000420LNF	GLOVEBOX ASSY-FACIA	45.05	52.93
FFB000420LPR	GLOVEBOX ASSY-FACIA	45.06	52.95
FFB000420SBA	GLOVEBOX ASSY-FACIA	45.06	52.95
FFB000430CVC	GLOVEBOX ASSY-FACIA	45.06	52.95
FFB000430LNF	GLOVEBOX ASSY-FACIA		

FJB100170LNF-GEX164

Part Number	Description	Price £ Ex VAT	Price £ Inc VAT
FJB100170LNF	LID-TUNNEL CONSOLE	29.95	35.19
FJB100180LNF	LID-TUNNEL CONSOLE	54.03	63.49
FJB100440CVC	LID ASSY-TUNNEL CONSOLE	ENQUIRE	
FJB100440LNF	LID ASSY-TUNNEL CONSOLE	11.97	14.06
FJB100440LPR	LID ASSY-TUNNEL CONSOLE	11.97	14.06
FJB100440SAV	LID ASSY-TUNNEL CONSOLE	ENQUIRE	
FJB100440SBA	LID ASSY-TUNNEL CONSOLE	100.25	117.79
FJB100450CVC	LID ASSY-TUNNEL CONSOLE	100.25	117.79
FJB100450LNF	LID ASSY-T/CONSOLE ASH GREY LEATHER	ENQUIRE	
FJB100450LPR	LID ASSY-TUNNEL CONSOLE	11.97	14.06
FJB100450PMA	LID ASSY-TUNNEL CONSOLE	124.59	146.39
FJB100450SAV	LID ASSY-TUNNEL CONSOLE	ENQUIRE	
FJB100450SBA	LID ASSY-T/CONSOLE LIGHT TAN LEATHER	29.79	35.00
FJB100500CVC	LID-TUNNEL CONSOLE REAR	ENQUIRE	
FJB100500LNF	LID-TUNNEL CONSOLE	11.97	14.06
FJB100500LPR	LID-TUNNEL CONSOLE REAR	11.97	14.06
FJB100500SAV	LID-TUNNEL CONSOLE	11.97	14.06
FJB100500SBA	LID-TUNNEL CONSOLE REAR	11.97	14.06
FJB100510CVC	LID-TUNNEL CONSOLE FRONT	ENQUIRE	
FJB100510LNF	LID-TUNNEL CONSOLE FRONT	11.97	14.06
FJB100510LPR	LID-TUNNEL CONSOLE FRONT	50.98	59.90
FJB100510SAV	LID-TUNNEL CONSOLE FRONT	ENQUIRE	
FJB100510SBA	LID-TUNNEL CONSOLE FRONT	11.97	14.06
FJL000090PMA	GAITER-GEAR LEVER	60.64	71.25
FJL000740ANV	GEARLEVER GAITER/FINISHER	ENQUIRE	
FJL000810LFD	AUTO GEARLEVER GAITER/FIN. MGZT LHD	4.26	5.01
FJL100710PMA	GAITER ASSY-GR LEVER	ENQUIRE	
FJL100720PMA	GAITER ASSY-H/BRAKE	24.92	29.28
FJL100720SAV	GAITER-HANDBRAKE	18.67	21.94
FJL101180CMS	GAITER ASSY-GR LEVER	51.98	61.08
FJL101180LPR	GAITER ASSY-GR LEVER	55.13	64.78
FJL101180VAC	GAITER ASSY-GR LEVER	ENQUIRE	
FJL101190CMS	GAITER ASSY-H/BRAKE	9.98	11.73
FJL101190LPR	GAITER ASSY-H/BRAKE	ENQUIRE	
FJL101190VAC	GAITER ASSY-H/BRAKE	ENQUIRE	
FJL101200CAC	GAITER-HANDBRAKE	ENQUIRE	
FJL101200CEN	GAITER-HANDBRAKE	16.75	19.68
FJL101200CVC	GAITER-HANDBRAKE	ENQUIRE	
FJL101200HDC	HANDBRAKE GAITER-GREEN LEATHER	ENQUIRE	
FJL101200HOV	GAITER-HANDBRAKE	16.11	18.93
FJL101200PUU	GAITER-HANDBRAKE	ENQUIRE	
FJL101200SAV	GAITER-HANDBRAKE	16.75	19.68
FJL101200SMK	GAITER-HANDBRAKE	20.17	23.70
FJL101200VAE	GAITER-HANDBRAKE	19.01	22.34
FJL101220CEN	GAITER ASSY-GR LEVER	ENQUIRE	
FJL101220CVC	GAITER ASSY-GR LEVER	ENQUIRE	
FJL101220HDC	GEARLEVER GAITER-GREEN LEATHER	ENQUIRE	
FJL101220PUU	GAITER ASSY-GR LEVER	24.51	28.80
FJL101220SAV	GAITER ASSY-GR LEVER	21.16	24.86
FJL101220SMK	GAITER ASSY-GR LEVER	25.86	30.39
FJL101920PMA	GAITER ASSY-GR LEVER	ENQUIRE	
FJL101930PMA	GAITER ASSY-GR LEVER	20.01	23.51
FJL102170PVB	GAITER-HANDBRAKE	ENQUIRE	
FJL102170SMB	GAITER-HANDBRAKE	18.02	21.17
FJL102170VAJ	GAITER-HANDBRAKE	ENQUIRE	
FJL102180PVB	GAITER ASSY-GR LEVER	ENQUIRE	
FJL102180SMB	GAITER ASSY-GR LEVER	55.13	64.78
FJL102190PVB	GAITER ASSY-GR LEVER	30.31	35.61
FJL102190SMB	GAITER ASSY-GR LEVER	31.54	37.06
FJL107340WTP	GEARLEVER GAITER/FINISHER	ENQUIRE	
FJL107420VAJ	GAITER ASSY-GEAR LEVER SEWN	ENQUIRE	
FJL107430VAJ	GAITER ASSY-GEAR LEVER SEWN	1.39	1.63
FJM100640PMA	PANEL-MTG-SWITCHES	8.63	10.14
FJM100650PMA	PANEL-MTG-SWITCHES	8.04	9.45
FJM100160PMA	RETAINER-GAITER-GEAR	12.79	15.03
FJV101000PMA	FINISHER-CONSOLE	10.25	12.04
FJV101910MDC	FINISHER	ENQUIRE	
FJV107000AFM	AUTO GEARLEVER GAITER/FINISHER	8.51	10.00
FJV107000MT	AUTO GEARLEVER GAITER/FINISHER	8.51	10.00
FKH100160MVK	ASHTRAY ASSY-FACIA	43.30	50.88
FKH100160PMA	ASHTRAY ASSY-T/CONSL	ENQUIRE	
FKH100210MMM	ASHTRAY ASSY-T/CONSL	76.87	90.32
FKH100230	USE FKH100230P		
FKH100230P	CHROME ASHTRAY KIT	54.47	64.00
FMK8959	HOSE-PUMP/ADAPT.A+B	2.04	2.40
FN105045	NUT	0.42	0.49
FN105047	NUT	0.81	0.95
FN106047	NUT	0.47	0.55
FN106047LP	NUT - FLANGED	0.34	0.40
FN108041	NUT M8	0.59	0.69
FN110041	NUT	0.55	0.65
FN112041	NUT	1.10	1.29
FNB10026	LOCK-GLOVEBOX	19.90	23.38
FNC100050	LATCH ASSY-GLOVEBOX	11.06	13.00
FND100080PMA	STRIKER-GLOVEBOX	4.63	5.44
FPB100110	STRIKER & SAFETY CATCH ASSY-BONNET	27.47	32.28
FP510007	LATCH ASSY-BONNET	27.44	32.24
FPT10005	PLATE-BONNET LATCH TOP	3.46	4.07
FQJ000010PMA	LATCH ASSY-FRONT DOOR	83.19	97.75
FQJ000080PMA	LATCH ASSY-FRONT DOOR	11.99	14.09
FQJ000090PMA	LATCH ASSY-FRONT DOOR	116.75	137.18
FQJ000120PMA	LATCH ASSY-FRONT DOOR	ENQUIRE	
FQJ102262PMA	LATCH ASSY-FRONT DOOR	142.05	166.91
FQJ102271PMA	LATCH ASSY-FRONT DOOR	119.99	140.99
FQJ102281PMA	LATCH ASSY-FRONT DOOR	119.99	140.99
FQJ102292PMA	LATCH ASSY-FRONT DOOR	142.05	166.91
FQJ100230	LATCH-TRUNK LID	34.58	40.63

WEB ORDER - YOU SHOP - WE DELIVER. www.rimmerbros.co.uk

Part Number	Description	Price £ Ex VAT	Price £ Inc VAT
FOW000040PMA	COVER-TAILGATE LATCH	5.51	6.47
FRC100090	CABLE-LOCK-TAILGATE	7.62	8.95
FS105101P	SCREW-MYLON PATCH	0.97	1.14
FS105165	OE*SCREW	0.38	0.45
FS105167	USE FS105165		
FS106107	SCREW-FLANGED HEAD	0.60	0.71
FS106121P	SCREW	1.78	2.09
FS106125	SCREW-FLANGED HEAD	0.60	0.71
FS106127	SCREW-FLANGED HEAD	0.60	0.71
FS106127ML	OE*BOLT - FLANGED HEX.	0.38	0.45
FS106141	USE FS106141L		
FS106141L	OE*SCREW	0.61	0.72
FS106165	SCREW-FLANGED HEAD	0.49	0.58
FS106167	SCREW-FLANGED HEAD - M6 X 16	0.38	0.45
FS106205	SCREW-FLANGED HEAD	0.60	0.71
FS106205E	SCREW-FLANGED HEAD	0.49	0.58
FS106206	OE*BOLT AND WASHER ASSY - HEX.HEAD	0.24	0.28
FS106206P	SCREW M6 X 20	0.09	0.11
FS106207	SCREW	0.60	0.71
FS106255L	SCREW-FOA	0.59	0.69
FS108161	EXHAUST SCREW	0.38	0.45
FS108207	USE FS108207L		
FS108207L	FLANGE SCREW	0.38	0.45
FS108255	SCREW-FLANGED HEAD	ENQUIRE	
FS108257	USE FS108257L		
FS108257L	OE*SCREW-FOA	0.61	0.72
FS108257M	OE*SCREW	0.54	0.63
FS108257MA	USE FS108257M		
FS108357A	BOLT	ENQUIRE	
FS110207	SCREW-FLANGED HEAD	0.52	0.61
FS110301	SCREW	1.26	1.48
FS112281L	OE*SCREW	0.96	1.13
FS112357	SCREW-FLANGE	1.10	1.29
FSC100130PMA	LEVER-BONNET RELEASE	7.39	8.68
FSC000160	CABLE ASSY-BONNET RELEASE ASSY	22.25	26.14
FSMGA	MGA S/S 3-PCX EXHAUST SYSTEM	134.74	158.32
FT106257MA	BOLT	2.76	3.24
FT108255	USE FT108255L		
FT108255L	SCREW	1.23	1.45
FTC5100A	SYNCHRO ASSY-1/2	29.79	35.00
FVC101740MMM	HANDLE-DOOR RELEASE	ENQUIRE	
FVC101750MMM	HANDLE-DOOR RELEASE	12.50	14.69
FVC102660MMM	HANDLE ASSY-INNER PANEL DOOR RELEASE13.24	15.56	
FVC102670MMM	HANDLE ASSY-INNER PANEL DOOR RELEASE14.31	16.81	
FVJ100120PMA	FINISHER-DOOR RELEASE ASSY ESCUTCHEO	5.45	6.40
FVJ100130PMA	FINISHER-DOOR REL	4.98	5.85
FVJ100200LNF	FINISHER-DOOR RELEASE ASSY ESCUTCHEO	1.86	2.19
FVJ100210LNF	FINISHER-DOOR RELEASE ASSY ESCUTCHEO	ENQUIRE	
FX106041	NUT	0.52	0.61
FX108047	NUT-FLANGE	1.05	1.23
FX112041L	OE*NUT M12	1.23	1.45
FX112041LP	NUT M12	0.85	1.00
FX112057	NUT-FLANGE	1.24	1.46
FY108046	OE*FLANGE - HEX.	0.33	0.39
FY108046P	NUT-FOA	0.17	0.20
G265433403105	USE G265433403107		
G265433403107	BEARING	10.54	12.38
G277532100138	BALL JOINT	31.82	37.39
G279009130131	ELEMENT	6.15	7.23
G279020100108	PUMP	59.46	69.87
GAC10024ML	LOCTITE STUD & BEARING(24ml)	16.12	18.94
GAC1003ML	LOCTITE STUD 'N' BEARING FIT-3ML	2.68	3.15
GAC1055X	AIR CLEANER-CHROME	43.83	51.50
GAC1065X	FOOTWELL MATS-BLACK-MGB'68>	67.23	79.00
GAC1072X	WIND DEFLECTOR MGB	147.23	173.00
GAC110	WD40-SMALL(200ml)	2.04	2.40
GAC111	AEROSOL WD40 (400ML)	3.36	3.95
GAC111 AC90	AEROSOL AC-90 LIQUID MAIN (VANFIT)	4.51	5.30
GAC2019	ANTIFREEZE 5 LTR.	13.40	15.75
GAC2082	USE RX1368		
GAC2999	SAFETY WAISTCOAT [LUMINOUS]	10.21	12.00
GAC4003	BOOT RACK MGB+C CHROME	182.98	215.00
GAC4032	USE RP1135 MG		
GAC4069FK	USE RP1134FK		
GAC4069P	USE RP1134 POLISHED		
GAC4098X	WINDSTOP MGB(MO BAG)	144.68	170.00
GAC4611	FOGLAMPS(P/R)-COOPER	36.59	42.99
GAC4617	REAR LENS KIT-CLEAR-MINI MK11>	12.34	14.50
GAC5005	USE XP5LL		
GAC5058	CLUTCH ALIGNMENT TOOL MGB'65>	5.11	6.00
GAC7032	USE RP1136		
GAC7033	USE RP1137		
GAC7045	USE RP1145		
GAC7046	USE RP1146		
GAC7106	BATTERY CHARGER [12VOLT]	35.70	41.95
GAC7203X	CORE PLUG SET MGB	2.13	2.50
GAC8496X	REAR LENS KIT-LH/RH C/W BULBS	39.56	46.48
GAC9903X-300ML	HOLT'S TYREWELD AEROSOL-300ml	5.92	6.96
GAC9903X-400ML	HOLT'S TYREWELD AEROSOL 400ml	8.30	9.75
GAC9903X-500ML	HOLT'S TYREWELD AEROSOL-500ml	12.13	14.25
GAC9904X	FIRE EXTINGUISHER(POWDER)1kg.	19.53	22.95
GAE191	REVERSE LIGHT SWITCH	7.45	8.75
GAE191A	REVERSE LIGHT SWITCH *OE*	10.27	12.07
GAM105	'BULLLET' DOOR MIRROR CHROME	15.10	17.74
GAM215A	MIRROR S+M/MIRRO-RH(CHROME)-CONVEX	29.52	34.69
GAT347	FOOT PUMP-DBL.BARREL(HEAVY DUTY)	22.13	26.00
GBA3015	12V BATTERY 35AMP	46.38	54.50
GBG169	USE SEG10005		
GBG170	USE SEG10006		
GBG90192	USE SMC000470		

Part Number	Description	Price £ Ex VAT	Price £ Inc VAT
GBC900193	USE SMC000460		
GBD168	USE SEH10003		
GBD607	USE NAM7806P		
GBD90607	USE NAM7806		
GBD90800	USE SDB090800EVA		
GBD90806	USE 21A2612EVA		
GBD90851	USE SDB000290		
GBF901	AEROSOL BRAKE CLEANER	3.06	3.60
GBH124	RR.BRAKE HOSE	10.37	12.18
GBH124GR	GOODRIDGE BRAKE HOSE (TUV APPROVED)	15.24	17.91
GBH157	USE SHB000157EVA		
GBH158	USE GBH158P		
GBH158P	BRAKE HOSE-FRT(MGB)-RR(S+M)	4.34	5.10
GBH158SS	BRAIDED S/S B/HOSE S+M & MGB	15.96	18.75
GBH159	USE SHB000159EVA		
GBH166	FLEXIBLE BRAKE HOSE	7.00	8.23
GBH166GR	GOODRIDGE BRAKE HOSE (TUV APPROVED)	14.15	16.63
GBH172	BRAKE HOSE MGB FRONT 75 ON	6.38	7.50
GBH313	USE SHB000313EVA		
GBH314	USE GBH314P		
GBH314P	BRAKE HOSE-RHR CALIPER	10.85	12.75
GBP102	USE 18G8336EVA		
GBP103	USE 18G8535EVA		
GBP103AF	USE 18G8535EVA		
GBP202GS	USE SFC000202EVA GS		
GBP281	BRAKE PADS ONLY-STANDARD	7.47	8.78
GBP281 GS	BRAKE PADS ONLY-GREENSTUFF (KEVLAR)	23.88	28.06
GBP281 K	BRAKE PAD KIT-STANDARD INC.FITTINGS	15.19	17.85
GBP281 GSK	BRK.PAD KIT-GREEN STUFF INC.FITTINGS	28.33	33.29
GBP307	USE CDU3030EVA		
GBP90306	USE SFC090306EVA		
GBP90306AF	USE SFC090306EVA		
GBP90323AF	USE SFP100360SLP		
GBP90337AF	USE SEM100020		
GBS740	USE SMN000740EVA		
GBS819AF	USE SMN000819EVA		
GBS834	USE 8G8814EVA		
GBS834AF	USE 8G8814EVA		
GBY063	BAT 063-UJF	45.96	54.00
GCB10813	FAN BELT	3.56	4.18
GCB10825	USE 12H3165EVA		
GCB10838	FAN BELT	3.06	3.60
GCB10863	USE GCB10863P		
GCB10863P	USE 2D10A0865C		
GCB10900	FAN BELT	3.90	4.58
GCB10914	D/BELT2L/2400TD	6.17	7.25
GCB10950	FAN BELT 1850	3.64	4.28
GCB11088	FAN BELT	6.17	7.25
GCB11125	FAN BELT EARLY	4.77	5.60
GCC90278	USE URB10009		
GCH112	EXHAUST JOINTING COMPOUND	3.23	3.80
GCK100AF	USE URF008855EVA		
GCK101	3-IN-1 CLUTCH KIT 1750 MAXI	67.23	79.00
GCK109	CLUTCH KIT MGB (OE TYPE)	78.30	92.00
GCK149AF	USE URF008652EVA		
GCK160	CLUTCH KIT 3-IN-1	62.13	73.00
GCK260P	USE GCK260P		
GCK260P	CLUTCH KIT 1098CC	73.19	86.00
GCK261	USE GCK261P		
GCK261P	CLUTCH KIT 1275CC	62.13	73.00
GCK3306			

Part Number	Description	Price £ Ex VAT	Price £ Inc VAT
GEX177	USE WDE000177EVA		
GEX33013	INT EXHAUST		ENQUIRE
GEX33013P	USE GEX33221P		
GEX33043	USE GEX3918		
GEX33054	USE GEX33054P		
GEX33054P	EXHAUST DOWNPIPE MG METRO TURBO	85.96	101.00
GEX33055	EXHAUST REAR ASSY MG METRO		ENQUIRE
GEX33062	USE GEX33062P		
GEX33062P	EXHAUST INTER MG MAESTRO BL27	123.40	145.00
GEX33063	USE GEX33063P		
GEX33063P	EXHAUST - REAR MG MAESTRO BL28	50.21	59.00
GEX33079	USE GEX33079P		
GEX33079P	EXHAUST-REAR ASSY	52.77	62.00
GEX33083	RR EXHAUST		ENQUIRE
GEX33152	USE GEX33054		
GEX33166	USE WCG033166EVA		
GEX33179	USE GEX33221P		
GEX33179P	USE GEX33221P		
GEX33196	USE GEX33428		
GEX33221	USE GEX33221P		
GEX33221P	EXHAUST INTERMEDIATE ASSY	61.28	72.00
GEX33231	USE GEX33231P		
GEX33231P	EXHAUST SILENCER	67.16	78.91
GEX33365	USE GEX33365P		
GEX33365P	EXHAUST-REAR MG METRO TURBO	68.08	79.99
GEX33428	EXHAUST DOWNPIPE MG METRO TURBO		ENQUIRE
GEX33479	USE WDE10002EVA		
GEX33519	USE WCE10116EVA		
GEX33524	USE WCG10062EVA		
GEX33541	USE WCD10227EVA		
GEX33546	USE WCG033546EVA		
GEX33565	EXHAUST SYSTEM-REAR	85.96	101.00
GEX33592	EXHAUST SYSTEM-REAR	49.36	58.00
GEX33641	USE WCD104210		
GEX33653	DOWNPIPE ASSY EXHAUST SYSTEM	75.73	88.98
GEX33659	USE EMP9109EVA		
GEX33659P	USE EMP9109EVA		
GEX33673	USE GEX33673P		
GEX33673P	DOWNPIPE ASSY EXHAUST SYSTEM	73.19	86.00
GEX33676	USE WCE103330EVA		
GEX33679	USE WCE103370LSL		
GEX33698	USE WCG102840SLP		
GEX33701	USE WCG102850SLP		
GEX33732	USE WCD103910EVA		
GEX3674	EXH.REAR SILENCER	23.79	27.95
GEX3917P	USE GEX3917P		
GEX3917P	EXHAUST DOWNPIPE MG METRO TURBO	86.81	102.00
GEX3918P	EXHAUST - REAR MG METRO TURBO	74.04	87.00
GEX7196	EXH.FLANGE GASKET MGA&C	2.55	3.00
GEX8025	USE WAG103910SLP		
GEX8036	USE GEX8036P		
GEX8036P	CATALYST	79.87	93.85
GEX8065	CATALYTIC CONVER		ENQUIRE
GEX8069	USE WAG103910SLP		
GEX8070	USE WAG103651		
GFE1003	USE PHE001003EVA		
GFE1004	USE PHE001004EVA		
GFE102	OIL FILTER CARTRIDGE	3.83	4.50
GFE103	USE LPZ000103EVA		
GFE1033	USE PHE001033EVA		
GFE104	OIL FILTER TR2/3/4	3.35	3.94
GFE1063	AIR FILTER.DOLOMITE/SPITFIRE/1500	5.92	6.96
GFE1096	USE 12G3699EVA		
GFE1143	USE PHE10015EVA		
GFE119	OIL FILTER	4.78	5.62
GFE121	USE 12H3274EVA		
GFE166	USE 12G2400EVA		
GFE171	OIL FILTER 2000	3.39	3.98
GFE197	USE LRF000197EVA		
GFE2334	USE PHE100420		
GFE2461	USE PHE100540		
GFE2496	USE PHE100540		
GFE295	FILTER		ENQUIRE
GFE7004	FUEL FILTER (IN LINE)	2.74	3.22
GFE7059	USE WJN101520EVA		
GFU103	FLASHER UNIT	4.42	5.19
GFU103 ORIG	USE 502096		
GFU2124	FLASHER UNIT	4.00	4.70
GFU2125	FLASHER UNIT	3.90	4.58
GFU2204	HAZARD FLASHER RELAY	3.60	4.23
GFU2221	FLASHER UNIT-ELEC	3.90	4.58
GGC102	BLUE HYLONAR 100g	5.06	5.95
GGL111	400GM GREASE (TUBE)	2.47	2.90
GGL175	USE GGL505		
GGL505	ATF TYPE G 5 LITRE	18.51	21.75
GHB102	HUB BEARING	8.30	9.75
GHC608	HOSE CLIP 16-25mm	0.94	1.10
GHF233	NYLOC NUT 10mm	0.59	0.69
GHF252	CLEVELOC NUT M8	0.77	0.90
GHF6093	INSTANT GASKET	3.66	4.30
GHK1005 MGB	USE RFC001005EVAP		
GHK1018	USE AAU8806EVA		
GHK1140	USE 21A1400EVA		
GHK1482	USE EDP7418EVA		
GHK1548	USE RFM001805EVA		
GHK1551	USE CKP7058EVA		
GHS114	FRONT HUB OIL SEAL P6	4.25	4.99
GHS115	OIL SEAL P6 ROVER	4.42	5.19
GHT102	HT LEAD SET (OE TYPE)	27.23	32.00

Part Number	Description	Price £ Ex VAT	Price £ Inc VAT
GHT102P	HT LEAD SET (SIDE ENTRY)	9.56	11.23
GHT106	USE NGC000106EVA		
GHT152	USE ERC3256P		
GHT182S	V8 SILICONE HT LEAD SET	32.95	38.72
GHT184	USE GHT184P		
GHT184P	HT LEAD SET MGB	9.57	11.24
GLB207	BULB 12v 5w S/C	0.43	0.51
GLB233	BULB 12v 4w	0.64	0.75
GLB239	BULB FESTOON 12v 5w	0.65	0.76
GLB245	BULB 12V10WSCC	0.64	0.75
GLB380	BULB 12v 21/5w	0.64	0.75
GLB380LED	BULB 12V 21/5W [LED]	7.87	9.25
GLB380LEDRED	BULB 12V 21/5W [LED]RED	6.81	8.00
GLB382	BULB 12V21W S/C	0.45	0.53
GLB382AMBER	BULB 12V21W S/C AMBER	1.11	1.30
GLB382LED	BULB 12V21W C/C [LED]	7.87	9.25
GLB382LED AMBER	BULB 12V21W C/C [LED] AMBER	6.81	8.00
GLB382SILVER	'SILVATEC'INDICATOR BULBS(PR)	6.81	8.00
GLB410	BULB HEADLIGHT 45/40w	1.87	2.20
GLB411	BULB HEADLAMP YELLOW 45/40w	3.15	3.70
GLB448	BULB HALOGEN 55WATT	3.28	3.85
GLB448 SILVER	H1 BULBS PHILIPS VISION PLUS PAIR	12.45	14.63
GLB448X	#PAIR# XENON BULBS	7.40	8.70
GLB453	BULB-HALOGEN 12V/55W	3.49	4.10
GLB472	BULB HALOGEN 60/55w	3.28	3.85
GLB472 SILVER	H4 BULBS PHILIPS VISION PLUS PAIR	16.37	19.23
GLB472BLUE	H4 BULB XENON BLUE	5.53	6.50
GLB472X	PAIR XENON BULBS	7.40	8.70
GLB476	BULB HALOGEN 60/55w (CADMIUM YELLOW)		ENQUIRE
GLB499	BULB-HEADLAMP	7.50	8.81
GLB499 SILVER	H7 BULBS PHILIPS SILVER STAR PAIR	18.94	22.25
GLB499BLUE	PR H7 BULBS [NARVA] XENON BLUE	16.98	19.95
GLB501	BULB 12v 5w	0.64	0.75
GLB501LED	BULB 12V 5W LED	4.42	5.19
GLB899	BULB 12v5w SIDE LAMP	0.64	0.75
GLP105	USE LPF000132EVA		
GLP109	OIL PUMP 'O' SERIES	48.08	56.49
GLP132	USE LPF000132EVA		
GLP138	OIL PUMP ASSY (1275CC A+ ENGS)	13.83	16.25
GLP139	OIL PUMP A SERIES (3 BOLT SPADE DRIVE)	13.62	16.00
GLP142	OIL PUMP 948/1098CC(A SERIES)	13.62	16.00
GLU104	S/BEAM RHD.XPL.	6.13	7.20
GLU105	HEADLAMP-INNER-S/BEAM 5.3/4"dia.	13.95	16.39
GLU132	SEALED BEAM UNIT RHD (NO PILOT) 60/45W 8.51	10.00	
GLU135	HEADLAMP-OUTER-S/BEAM RHD	14.06	16.52
GLU515	HEADLIGHT LHD - WITH PILOT LIGHT	22.34	26.25
GMC1007	USE STC001007EVA		
GMC150	BRAKE M/CYL SINGLE LINE-MGB ->76	44.25	51.99
GMC151	USE GMC151P		
GMC151P	BRAKE MASTER CYLINDER S+M' 67-77	40.42	47.49
GMC164	USE SJC000164EVA		
GMC166	USE GMC166P		
GMC166P	B/M/CYLINDER 1500 RHD'77/8 *NCA*	49.36	58.00
GMC170	USE GMC170P		
GMC170P	BRAKE MASTER CYLINDER-1500(TANDEM)	96.17	113.00
GMC90360	USE SJC10005		
GMC90361	USE SJC10007		
GNU2256	USE ADU7774E GNU2521 USE YLE101790E		
GPS133	OIL PRESS.SWITCH	3.56	4.18
GRA101	ROTOR ARM	1.96	2.30
GRA101RED	ROTOR ARM(AS ORIG.RED)	7.23	8.50
GRA112	ROTOR ARM	3.55	4.17
GRA114	ROTOR ARM	1.87	2.20
GRA114RED	ROTOR ARM(AS ORIG.RED)	7.23	8.50
GRA139	USE NJE002123EVA		
GRA2123	USE NJE002123EVA		
GRA2138	USE AUU1690EVA		
GRA2143	ROTOR ARM	2.89	3.40
GRA2274	USE AUU1690EVA		
GRA2310	USE NJE100070SLPP		
GRC101	RAD.CAP 7PSI LONG REACH	3.49	4.10
GRC102	RADIATOR CAP (7lbs psi)	3.40	4.00
GRC110	RADIATOR CAP 15 PSI	3.32	3.90
GRD110	USE ARP2000EVA		
GRD135	USE PCC104080SLP		
GRD139	USE PCC001086EVA		
GRD172	USE PCC103980SLP		
GRD173	RADIATOR ASSY	195.73	229.98
GRD812	USE PCC104260EVA		
GRD927	USE PCC105740SLP		
GRD936	USE PCC104080SLP		
GRH1242	USE PCH10735EVA		
GRH1466	USE PCH113480EVA		
GRH240	USE 12A1550EVA		
GRH244	USE PCH000244EVA		
GRH245	USE 12G1163EVA		
GRH247	USE GRH247P		
GRH247P	TOP HOSE COOPER & COOPER S	3.66	4.30
GRH305	USE PCH000305EVA		
GRH468	USE GRH468P		
GRH468P	RADIATOR BOTTOM HOSE MINI CLUBMAN	8.94	10.50
GRH469	USE GRH469P		
GRH469P	TOP HOSE 1275GT	8.94	10.50
GRH498	USE PCH000498EVA		
GRH592	TOP RAD.HOSE MGB '76ON	6.38	7.50
GRH641	USE PCH000641EVA		
GRH903	HEATER HOSE-LOWER MGB	3.32	3.90
GRH1006	REPAIR KIT-B/M/CYLINDER-MINI	2.38	2.80
GRK4035	SLAVE CYL./R/KIT	4.08	4.79
GRK5006	CALIPER REPAIR KIT-MINI 'S'	3.95	4.64

Part Number	Description	Price £ Ex VAT	Price £ Inc VAT
GRK5007	CALIPER REPAIR KIT MGB V8	5.95	6.99
GSA102	USE GSA102P		
GSA102E	RHF S/ABSORBER(SPRITE/MIDGET)EXCH.	18.30	21.50
		25.00	29.38
GSA102P	RHF S/ABS.S+M NEW	81.70	96.00
GSA103	USE GSA103P		
GSA103E	LHF S/ABSORBER(SPRITE/MIDGET)EXC	18.30	21.50
		25.00	29.38
GSA103P	LHF S/ABS.S+M NEW	81.70	96.00
GSA119	USE GSA119P		
GSA119E	FRONT S/ABS RECON. MGB & V8	18.30	21.50
		25.00	29.38
GSA119P	FRONT S/ABSORBER *NEW*MGB&V8	118.30	139.00
GSA149	USE GSA149P		
GSA149E	RHR S/ABSORBER S+M	18.30	21.50
		25.00	29.38
GSA149P	RHR S/ABSORBER S+M	77.45	91.00
GSA150	USE GSA150P		
GSA150E	LHR S/ABSORBER S+M	18.30	21.50
		25.00	29.38
GSA150P	LHR S/ABSORBER S+M	77.45	91.00
GSA168	USE GSA168P		
GSA168E	RH REAR S/ABS. RECON.MGB/C & V8	18.30	21.50
		15.00	17.63
GSA168P	RHR S/ABSORBER MGB/C/V8 *NEW*	70.64	83.00
GSA169	USE GSA169P		
GSA169E	LH REAR S/ABS. RECON. MGB/C & V8	18.30	21.50
		15.00	17.63
GSA169P	LHR S/ABSORBER MGB/C/V8 *NEW*	70.64	83.00
GSA2064	STRUT-REAR		ENQUIRE
GSA71541	USE RBB071541EVA		
GSA71542	USE RPD071542EVA		
GSA971574	USE RPD000180		
GSA972064	USE NAM3959EVA		
GSA98301P	RHF SHOCK ABSORBER (ROVER220GT)	42.98	50.50
GSA98302P	LHF SHOCK ABSORBER (ROVER220GT)	51.90	60.98
GSC109	CONDENSER	2.13	2.50
GSC111	CONDENSER	2.89	3.40
GSC113	CONDENSER	2.30	2.70
GSC118	CONDENSER	3.66	4.30
GSD102	USE GSD102P		
GSD102P	SPEEDO CABLE MINI	6.38	7.50
GSD152	USE GSD152P		
GSD152P	SPEEDO CABLE MINI	8.30	9.75
GSD402	USE ADU5919EVA		
GSD415	USE YBD000415EVA		
GSD417	USE YBD000417EVA		
GSD418	USE YBD000418EVA		
GSD487	USE YBD10101EVA		
GSD488	USE YBD10075EVA		
GSJ1087	USE RBJ001087EVA		
GSJ1088	USE RBJ001088EVA		
GSJ166	USE 8G4197EVA		
GSJ168	USE RBK000168EVA		
GSJ269	USE RBG000020SLP		
GJ301	USE RBK000301EVA		
GJ734	USE QJB10004EVA		
GSP4352	USE NLP004352EVA		
GSP4362	SPARK PLUG (STANDARD)	2.25	2.64
GSP4376	SPARK PLUG	1.40	1.65
GSP4382	SPARK PLUG (STANDARD)	2.25	2.64
GSP4462	SPARK PLUG	2.60	3.06
GSP6462	SPARK PLUG DOUBLE CORE	2.21	2.60
GSR135	STEERING RACK RHD MGB'74->NEW	128.51	151.00
GSR136	STEERING RACK-RHD MGB'62-74	125.96	148.00
GSR3359E	RACK-STRG-MGB-RHD		ENQUIRE
GSV1006	USE GSV1006P		
GSV1006P	REAR SPRING MGB	42.13	49.50
GSV1062	S/RACK GATR.KIT	22.62	26.58
GSV1073	USE BHM7012EVA		
GSV1155	USE TDR001155EVA		
GSV1175	USE RHM10001EVA		
GSY106	USE BMK192EVA		
GSY107	CLUTCH SLAVE CYLINDER MID1500	24.04	28.25
GSY110	CLUTCH SLAVE CYLINDER S+M	11.90	13.98
GSY195	USE UUB100040		
GTG101	USE 12G330EVA		
GTG103	THERMOSTAT HOUSING GASKET	0.37	0.43
GTG116	THER		

GVC2328-L2LRT00186

Part Number	Description	Price £ Ex VAT	Price £ Inc VAT
GVC2328	USE NAM5604EVA		
GVC902384	USE SPB000610		
GVC902385	USE SPB000600		
GWB142	WIPER BLADE MGBGT '65>'69	7.53	8.85
GWB197	WIPER BLADE SILVER	9.95	11.69
GWB219	WIPER BLADE 10" SILVER	6.17	7.25
GWB711	WIPER BLADE BLK11"	5.32	6.25
GWB911	USE DKC00029SLP		
GWC102	USE SML00102EVA		
GWC1102	USE 17H8152EVA		
GWC1103	USE 17H8735EVA		
GWC1114	WHEEL CYL.S&M MK1	20.85	24.50
GWC1115	USE GWC1115P		
GWC1115P	REAR WH.CYL. SPRITE MK2	20.00	23.50
GWC1122	USE SML001122EVA		
GWC1129	USE SML001129EVA		
GWC1132	REAR W/CYLINDER MAXI	17.45	20.50
GWC126	USE 37H2015EVA		
GWC127	USE SML000127EVA		
GWP101	USE GWP132		
GWP111	WATER PUMP MGC	61.28	72.00
GWP114	USE GWP114P		
GWP114P	WATER PUMP MGB '65-'71	42.98	50.50
GWP115	USE PEB000115EVA		
GWP130	USE GWP130P		
GWP130P	WATER PUMP ALLY.MGB	19.15	22.50
GWP132	USE PEB000132SLP		
GWP154	USE CAM4256EVA		
GWP155	WATER PUMP 2LITRE PETROL	25.53	30.00
GWP156	PUMP WATER		ENQUIRE
GWP156P	WATER PUMP	24.08	28.29
GWP187	USE PEB10036EVA		
GWP188	USE PEB10037EVA		
GWP310	WATER PUMP V8	56.65	66.56
GWP317	WATER PUMP V8 70>85	36.06	42.37
GW802	USE GW802CHROME OR GW802BLACK		
GW802BLACK	WASHER JET-BLACK	1.96	2.30
GW802CHROME	WASHER JET CHROME	2.91	3.42
GW904	WASHER BOTTLE OE.TYPE	14.15	16.63
GXE2257	USE GXE2257P		
GXE2257P	ALTERNATOR A115 MINI SURCHARGE	59.56	69.98
GXE3101	DYNAMO (C40) RECON SURCHARGE	41.02	48.20
GXE4404	USE 13H5799E		
GXE4418	STARTER MOTOR MGB'62-'67' SURCHARGE	73.19	86.00
GXE4418X	USE GEU9405UR		
GXE4418X	STARTER MOTOR MGB '68>(NEW)	78.22	91.91
GXE4441R	STARTER MOTOR MGB '68>(RECON) SURCHARGE	97.87	115.00
GXE4527	USE ADU9800E		
GXE4537	STARTER MOTOR	156.59	183.99
GXE7714	WIPER MOTOR NEW (SINGLE SPEED) SURCHARGE	129.95	152.69
GXE7714R	WIPER MOTOR RECON (SINGLE SPEED) SURCHARGE	67.04	78.77
GXE8211	ALTERNATOR (17ACR) SURCHARGE	46.94	55.15
GZA2083	USE 12A2178EVA		
GZA2086	USE 12A2178EVA H030 USE CK12		
HFA103820	FRAME-FRONT SEAT SQUAB	88.54	104.03
HFA103830	FRAME-FRONT SEAT SQUAB	88.54	104.03
HFA105220	FRAME-FRONT SEAT SQUAB	102.03	119.89
HFA105230	FRAME-FRONT SEAT SQUAB	86.21	101.30
HFB102240	FRAME ASSY-MAN FRONT SEAT CUSHION	19.95	23.44
HFB102250	FRAME ASSY-MAN FRONT SEAT CUSHION	19.95	23.44
HFFK1	FUEL PIPE KIT MGB'65-'71 CB	42.13	49.50
HGA100720	OVERLAY-FRONT SEAT SQUAB		ENQUIRE
HGA100730	OVERLAY-FRONT SEAT SQUAB CENTRE	14.71	17.28
HGA101060	OVERLAY-FRONT SEAT SQUAB		ENQUIRE
HGB100640	OVERLAY-FRONT SEAT CUSHION	34.05	40.01
HGB101050	OVERLAY-FRONT SEAT CUSHION	42.74	50.22
HMCC1003	USE HMCC1003DVD		
HMCC1003DVD	DVD SPRITE/MIDGET 57-64	19.15	22.50
HMCC2006	USE HMCC2006DVD		
HMCC2006DVD	DVD BL SPECIAL TUNING DATA & PARTS	19.15	22.50
HMCC3005	USE HMCC3005DVD		
HMCC3005DVD	DVD MGB 62-69	19.15	22.50
HMCC3006	USE HMCC3006DVD		
HMCC3006DVD	DVD MGB 70-74	19.15	22.50
HMCC3007	USE HMCC3007DVD		
HMCC3007DVD	DVD MGB 74-80	19.15	22.50
HMCC3008	USE HMCC3008DVD		
HMCC3008DVD	DVD MGB GT V8 & MGRV8	19.15	22.50
HMCC3009	USE HMCC3009DVD		
HMCC3009DVD	DVD SPRITE/MIDGET 64-74	19.15	22.50
HMCC3010	USE HMCC3010DVD		
HMCC3010DVD	DVD MIDGET 74-79	19.15	22.50
HMCC4001	USE HMCC4001DVD		
HMCC4001DVD	DVD MINI 1959-69	19.15	22.50
HMCC4002	USE HMCC4002DVD		
HMCC4002DVD	DVD MINI 1969-85	19.15	22.50
HMCC4003	USE HMCC4003DVD		
HMCC4003DVD	DVD MINI 1985-00	19.15	22.50
HMP118099AMB	HARDTOP BLACK GEL STD H/L	893.62	1050.00
HMP118099MGR	ORIG. MGF HARDTOP (GREY PRIMER)	795.00	934.13
HMP441016	BOOT FLOOR CPTE.-MINI	129.36	152.00
HYP100230	SCREW-WASHER	0.45	0.53

WEB ORDER - YOU SHOP - WE DELIVER. www.rimmerbros.co.uk

Part Number	Description	Price £ Ex VAT	Price £ Inc VAT	Part Number	Description	Price £ Ex VAT	Price £ Inc VAT
HYR10002	STUD	0.95	1.12	JUE000181	PIPE-EVAPORATOR/COMPRES AIR COND	63.68	74.82
HZA231	REINFORCEMENT-JACK POINT	2.17	2.55	JUE000191	PIPE-EVAPORATOR/COMPRES AIR COND	63.68	74.82
HZA4014	BONNET ASSY-MGB OE	280.81	329.95	JUE000720	PIPE-COMPRESSOR/COND AIR COND	90.33	106.14
HZA4014P	BONNET ASSY. MGB REPRO	116.59	136.99	JUE105170	PIPE-SUCTION-AIR COND	28.19	33.12
HZA496P	RH OUTER SILL	37.02	43.50	JUE105510	PIPE-COMPR/COND	74.13	87.10
HZA497P	LH OUTER SILL	37.02	43.50	JUE105800	PIPE-COMPR/RECEIVER DRY AIR CONDITIO	108.91	127.97
HZA566	DOOR SKIN-RH MGB	64.68	76.00	JUE105810	PIPE-COMPR/RECR DRY	95.45	112.15
HZA566P	RH DOOR SKIN	45.53	53.50	JUE105821	PIPE-RECEIVER DRY/EVAP AIR COND14.89	17.50	
HZA567	DOOR SKIN-LH MGB	64.68	76.00	JUE105831	PIPE-RECEIVER DRY/EVAP AIR CONDITI		ENQUIRE
HZA567P	LH DOOR SKIN	45.53	53.50	JUE105841	PIPE-EVAPORATOR/COMP AIR COND	131.10	154.04
J2160MM	CLIPDRIVER-JUBILEE 160MM	4.25	4.99	JUE105851	PIPE-EVAPORATOR/COMP AIR COND	121.55	142.82
J295MM	CLIPDRIVER-JUBILEE 95MM	3.95	4.64	JUE107004	USE JUE001250		
J2FLEXDRIVER	FLEXDRIVER-JUBILEE	6.77	7.95	JUF000220	HOSE-COMPR/COND AIR CONDITION	151.80	178.37
JBD100650ALU	VENT-DASHBOARD CENTRE ALUMINIUM		ENQUIRE	JUF101740	HOSE-COMPR/COND	162.55	191.00
JBD100650CHR	VENT-DASHBOARD CENTRE CHROME		ENQUIRE	JUF102140	HOSE-EVAP/COMPR		ENQUIRE
JBD100650PMA	VENT-DASHBOARD CENTRE BLACK	26.33	30.94	JUU000060	O RING AIR CONDITIONING	2.41	2.83
JBD100650SIL	VENT-DASHBOARD CENTRE POLISHED SILVER		ENQUIRE	JUU000070SLP	O RING AIR CONDITIONING	2.14	2.51
JBD100680PMA	VENT ASSY-FACIA	17.62	20.70	JUU100240	O RING	2.13	2.50
JBD100690PMA	VENT ASSY-FACIA	17.62	20.70	JWD10002	BULB AND HOLDER	4.98	5.85
JBD101000ANU	VENT ASSY-FACIA	114.81	134.90	JYX100150	O RING	0.36	0.42
JBD101010ANU	VENT ASSY-FACIA	118.83	139.63	JYX100160	O RING	0.36	0.42
JCC100270ALU	BEZEL-WINDSCREEN DEMIST ALUMINIUM		ENQUIRE	KACB101	CLEANING BRUSH	6.81	8.00
JCC100270CHR	BEZEL-WINDSCREEN DEMIST CHROME PAIR		ENQUIRE	KAH100050	HANDLE-JACK		ENQUIRE
JCC100270PMA	BEZEL-WINDSCREEN DEMIST BLACK EACH 14.37	16.88		KAJ100410	USE KAJ100410P		
JCC100270SIL	BEZEL-WINDSCREEN DEMIST SILVER PAIR		ENQUIRE	KAJ100410P	SCISSOR JACK/HANDLE 1 TONNE	19.56	22.98
JEC000940	HEATER ASSY RHD MGT	165.96	195.00	KAJ100460	USE 311346		
JEC000950	HEATER ASSY	318.04	373.70	KAL100040	WHEELBRACE	12.87	15.12
JEC102080	HEATER ASSY RHD.		ENQUIRE	KBK000130	KIT-TOOL & STOWAGE ASSY	31.64	37.18
JEC102220	HEATER ASSY RHD MGF	165.96	195.00	KBK100420	KIT-TOOL & STOWAGE		ENQUIRE
JEC102230	HEATER ASSY	322.63	379.09	KC4282L MG	2 EARED CENTRE KNOCK CAP LH [MG]	17.66	20.75
JEF000080P	HEATER MATRIX	102.09	119.96	KC4282R MG	2 EARED CENTRE KNOCK CAP RH [MG]	17.66	20.75
JEF000100P	MATRIX-HEATER	97.83	114.95	KCC100080	USE RX1344		
JEF10003	MATRIX-HEATER-HEATER	42.55	50.00	KDB000010	USE S3SSFE1		
JFC000450PMA	CONTROL ASSY HEATER	111.02	130.45	KDB000020	USE S3SSFE1		
JFC001420	HEATER CONTROL ASSY		ENQUIRE	KFF000010	SEALANT-INSTANT MOBILITY SYSTEM	24.08	28.29
JFC101800PMA	CONTROL ASSY-HEATER		ENQUIRE	KFG000010	PROTECTOR-EYE	4.49	5.28
JFC102740PMA	CONTROL ASSY-HEATER	205.12	241.02	KGB000160	SUBFRAME ASSY-FRONT SUSPENSION	600.78	705.92
JFC102750PMA	CONTROL ASSY-HEATER		ENQUIRE	KGB10027	SUBFRAME ASSY-SUSPN	319.15	375.00
JFD000060	KNOB-CONTROL HEATER	15.03	17.66	KGB100500	SUBFRAME ASSY-SUSPN	493.51	579.87
JFD000070	KNOB-CONTROL HEATER	21.03	24.71	KGB100891	SUBFRAME ASSY-SUSPN	600.78	705.92
JFD100590PMA	KNOB-CONTROL-HEATER	7.86	9.24	KGE000071	MOUNTING-FRONT SUBFRAME REAR	46.63	54.79
JFF10003	CABLE-CONTROL HEATER	30.56	35.91	KGE000110	MOUNTING-FRONT SUBFRAME RUBBER	15.34	18.02
JFF10003P	HEATER CABLE MINI 89 ON	8.94	10.50	KGE10001	MOUNTING-RR-SUBFRAME	40.57	47.62
JFF10048	CABLE-CONTROL HEATER		ENQUIRE	KGE100150	MOUNTING-FRONT SUBFRAME REAR RUB	41.59	48.87
JFF10048P	HEATER CABLE MINI	9.79	11.50	KGK100500	LONGITUDINAL-UPPER	76.39	89.76
JFF10051	USE JFF10051P			KGK100510	LONGITUDINAL-UPPER	76.39	89.76
JFF10051P	HEATER CABLE-MINI	24.68	29.00	KHB000070	SUBFRAME ASSY-REAR SUSPENSION	766.37	900.48
JFF100830	CABLE-CONTROL HEATER	18.62	21.88	KHB10008	SUBFRAME REAR STD.		ENQUIRE
JFF100840	CABLE-CONTROL HEATER	18.62	21.88	KHB100922	SUBFRAME REAR-SUSPN	621.81	730.63
JFF100910	CABLE-COOLANT VALVE	23.42	27.52	KHC10010	MOUNTING ASSY-RR SUB		ENQUIRE
JGC100140	MOTOR & FAN BAL ASSY	283.23	332.80	KHC10010P	REAR SUBFRAME MOUNTING BUSH RH	13.07	15.36
JGC100150	MOTOR & FAN BAL ASSY	302.01	354.86	KHC10011	MOUNTING ASSY-RR SUB	28.40	33.37
JGM100060	RESISTOR-PACK HEATER	42.98	50.50	KHC10011P	REAR SUBFRAME MOUNTING BUSH LH	13.07	15.36
JHB100450	HOSE-HEATER-INLET	5.50	6.46	KHL000010	LONGITUDINAL-REAR SUBFRAME UPPER	52.67	61.89
JHB100460	HOSE-HEATER-INLET	5.50	6.46	KHL100141	LONGITUDINAL ASSY	61.25	71.97
JHC100240	HOSE-HEATER-OUTLET	7.10	8.34	KHL100170	LONGITUDINAL ASSY	60.54	71.13
JHN100010	SCREW-BLEED	3.00	3.53	KHL100190	LONGITUDINAL-REAR SUBFRAME UPPER	65.73	77.23
JJB10011	VALVE ASSY-COOLANT	33.26	39.08	KKB101441	MOUNTING-RIGHT HAND SIDE ENGINE	41.86	49.19
JJB10011P	HTR.VALVE MINI (REMOTE MOUNT-ENG.BAY)	29.95	35.19	KKB101820	MOUNTING-LEFT HAND SIDE ENGINE	34.54	40.58
JJB100260	VALVE ASSY-COOLANT	33.26	39.08	KKB101890	MOUNTING-ENGINE	70.21	82.50
JJB100280	VALVE ASSY-COOLANT	83.79	98.45	KKF000040	BUSH	8.06	9.47
JKR000030	FILTER-POLLEN AIR INTAKE	34.24	40.23	KKF10005	BUSH	10.25	12.04
JKR000030 ASSY	POLLEN FILTER C/W HOUSING (ORIG MGR)		ENQUIRE	KKF100030	BUSH-TIE ROD MTG	1.37	1.61
JKR000030P	FILTER POLLEN AIR FILTER	17.63	20.72	KKF100390	ENGINE STABILIZER BUSH MINI	0.95	1.12
JKR000040	FILTER-POLLEN/ODOUR AIR INTAKE	54.09	63.56	KKF100390POLY	ENGINE STABILIZER BUSH MINI-POLY	2.13	2.50
JKR100020	FILTER-POLLEN AIR INTAKE	20.85	24.50	KKG10015	HOUSING & BUSH ASSY		ENQUIRE
JKR100020P	POLLEN FILTER	18.53	21.77	KKG10015P	HOUSING & BUSH ASSY	22.98	27.00
JKR100080	FILTER-POLLEN-AIR	24.77	29.10	KKK100371	HOUSING & BUSH ASSY-TIE ROD	68.05	79.96
JKR100080P	CABIN FILTER	17.99	21.14	KKH100782	ROD ASSY-TIE	38.21	44.90
JKR100220	FILTER-POLLEN-AIR	27.28	32.05	KKH102571	ROD ASSY-TIE	20.60	24.21
JKR100220P	USE JXK100010P			KKK100110	SPACER-ENGINE MTG	3.46	4.07
JXK100010	ELEMENT-FILTER	20.58	24.18	KKK100800	ARM ASSY-ENGINE MTG	47.49	55.80
JXK100010P	CABIN FILTER	11.70	13.75	KKK101424	ARM ASSY-ENGINE MOUNTING	38.53	45.27
JMF000020	FLUID AIR CON (R134A)	15.92	18.71	KKU103820	BRACKET-ENGINE MTG		ENQUIRE
JPB000060	COMPRESSOR ASSY-A/C	755.13	887.28	KLM2150	KENLOWE AUTO SNGL.SPEED ELEC T'STAT	32.95	38.72
JPC7182PMA	KNOB-CONTROL-MIRROR	2.46	2.89	KLM2455	KENLOWE AUTO TWO-SPEED ELEC T'STAT	40.95	48.12
JPC9110LML	COVER ASSY-FR BUMPER	38.12	44.79	KNB100470	TOWBAR-FIXED	120.97	142.14
JPC9111LML	COVER ASSY-RR BUMPER	130.24	153.03	KNB100670	TOWING-ATTACH ASSY	131.88	154.96
QJB101090	EVAPORATOR ASSY-ACON	99.25	116.62	KNB100670P	TOWING-ATTACH ASSY NON-DETE9	99.00	116.33
QJB101100	EVAPORATOR ASSY-ACON	466.56	548.21	KNB100690	TOWING-ATTACH ASSY	203.75	239.41
QJB101660	EVAPORATOR ASSY-ACON	99.25	116.62	KNB100690P	TOWING-ATTACH ASSY (DETACHABLE)	136.17	160.00
QJB101670	EVAPORATOR ASSY-ACON	99.25	116.62	KNB105710	TOWING ATTACHMENT ASSY	212.50	249.69
QJD100250	VALVE-AIR CON	123.68	145.32	KNB105710P	TOWING ATTACHMENT ASSY(DETACH)	136.17	160.00
QJL100040	THERMOSTAT-AIR CON	95.37	112.06	KYP10002	USE KYP10002L		
QJY100080	PLATE-BLANKING	2.67	3.14	KYP10002L	OE-SCREW	0.38	0.45
QJY100100	PLATE ASSY-STEERING COLAIR CONDI	6.03	7.09	KYP10005	SCREW-FLANGED HEAD		ENQUIRE
JRB100180							

Part Number	Description	Price £ Ex VAT	Price £ Inc VAT
L2LRT00234	STARTER MOTOR	90.04	105.80
	<i>SURCHARGE</i>	31.00	36.43
L3BHV566E	BRAKE CALIPER	62.78	73.77
	<i>SURCHARGE</i>	25.00	29.58
L3BHV567E	BRAKE CALIPER	62.78	73.77
	<i>SURCHARGE</i>	25.00	29.58
L3DF4197	BRAKE DISC (PAIR)	43.57	51.19
L3DF4197 ROS	ROSSINI PERFOR DISCS**PAIR**FRT.VENTED	140.42	164.99
L3DF4197UR	TURBO GROOVE BRAKE DISC **PAIR**	128.51	151.00
L3DF4198	BRAKE DISC (PAIR)	37.02	43.50
L3DF4198 ROS	ROSSINI PERFOR DISCS**PAIR**REAR SOLD	129.36	152.00
L3DF4198UR	TURBO GROOVE BRAKE DISC **PAIR**	112.34	132.00
L3GDB1476	BRAKE PADS	26.69	31.36
L3GDB1476GS	EBC GREENSTUFF BRAKE PADS FRONT	51.06	60.00
L3GDB1477	BRAKE PADS	24.28	28.53
L3GDB1477GS	EBC GREENSTUFF BRAKE PADS REAR	44.68	52.50
L3GDB1561	BRAKE PADS	23.72	27.87
L3GDB1561GS	EBC GREENSTUFF K BRAKE PADS REAR	44.68	52.50
L3GIC185	WARNING CABLE	8.92	10.48
L3GIC186	WARNING CABLE	9.18	10.79
L3PFB401	1 LITRE DOT 4 BRAKE FLUID	8.32	9.78
L3PFB440	1 LITRE DOT 4 ESP	10.08	11.84
L3PHD479	BRAKE HOSE	14.82	17.41
L3PHD479 GOODRIDGE	USE RBMW1003 OR RBMW1004		
L3PHD485	BRAKE HOSE	12.40	14.57
L3PHD485 GOODRIDGE	USE RBMW1003 OR RBMW1004		
LB8001520SR	ENGINE - SERVICE REPLACEMENT	1895.00	2226.63
	<i>SURCHARGE</i>	450.00	528.75
LB8002300	STRIPPED ENGINE-VVC 160PS (NEW)	ENQUIRE	
LB8002450 ASSY1	1.4 16V NEW K SERIES ENGINE ASSY	1200.00	1410.00
LB8002580	STRIPPED ENGINE 4.6 V8 (NEW)	ENQUIRE	
LB8107850SR	ENGINE - SERVICE REPLACEMENT	1575.00	1850.63
	<i>SURCHARGE</i>	450.00	528.75
LB8108410SR	ENGINE - SERVICE REPLACEMENT	1895.00	2226.63
	<i>SURCHARGE</i>	450.00	528.75
LB8110660N	STRIPPED ENGINE ASSY	995.00	1169.13
LB8111600SR	ENGINE - SERVICE REPLACEMENT	1550.00	1821.25
	<i>SURCHARGE</i>	450.00	528.75
LB8111761SR	ENGINE - SERVICE REPLACEMENT	1350.00	1586.25
	<i>SURCHARGE</i>	450.00	528.75
LCF000221	OE*CYLINDER ASSY - SHORT BLOCK	ENQUIRE	
LCF105160	CYLINDER BLOCK ASSY BMW 2L DIESEL	500.00	587.50
LCJ000050	USE LCJ000050SLP		
LCJ000050SLP	LINER-ENGINE CYLINDER	38.69	45.46
LCJ000050SLPP	CYLINDER LINER-K'SERIES	28.51	33.50
LCN000140L	RAIL	41.70	49.00
LCN100210	RAIL-ENGINE CLAMPING & OIL FEED	33.50	39.36
LDF000980	CYLINDER HEAD ASSY 1.8 VVC	849.00	997.58
LDF10075	HEAD ASSY-CYLINDER 1.6	ENQUIRE	
LDF108520	CYLINDER HEAD/CAMSHAFT CAR ASSY-	595.00	699.13
LDF109380R	USE LDF109380SR		
LDF109380SR	CYLINDER HEAD ASSY-ENGINE	695.00	816.63
	<i>SURCHARGE</i>	150.00	176.25
LDL100210	PLATE-BLANKING	ENQUIRE	
LDN10018	BOLT-FLANGED HEAD	2.45	2.88
LDN10027	BOLT-CYLINDER HEAD FIXING	10.99	12.91
LDN10027P SET	BOLT-CYLINDER HEAD FIXING	41.28	48.50
LDR000400	COVER-SPARK PLUG	17.02	20.00
LDR000431	COVER-CAMSHAFT CARRIER	79.01	92.84
LDR10074	COVER-VALVE ROCKER	47.21	55.47
LDR10074 ALLOY	POLISHED ALLOY ROCKER COVER (RIBBED)	22.34	26.25
LDR10074 ALLOY KIT	POLISHED ALY.RKR.CVR.(RIBBED)	36.59	42.99
LDR10074 ALLY SR KIT	ALY.RKR.CVR.(SLANTED & RIBBED)	74.89	88.00
LDR102800	USE LDR103810		
LDR103260	COVER-CAMSHAFT CARRIER	88.45	103.93
LDR103810	OE*COVER	7.76	9.12
LDR104511	COVER ASSY-CAMSHAFT CARRIER	72.64	85.35
LEF101770	CRANKSHAFT ASSY-ENGINE	413.60	485.98
LEF101790	CRANKSHAFT ASSY-ENGINE	545.88	641.41
LFB000150BLU	BEARING-HALF BIG END CONNECTING ROD	6.06	7.12
LFB000150RED	BEARING-HALF BIG END CONNECTING ROD	6.65	7.81
LFB000150YEL	USE LFB000150300		
LFB10001BLU	BEARING-HALF BIG END CONNECTING ROD	7.31	8.59
LFB10001RED	BEARING-HALF BIG END CONNECTING ROD	7.26	8.53
LFB10001YEL	BEARING-HALF BIG END CONNECTING ROD	6.80	7.99
LFL000780	PISTON & CONNECTING ROD ASSY-ENGINE	168.68	198.20
LFL000790	PISTON&CON ROD ASSY	183.23	215.30
LFL000800	PISTON&CON ROD ASSY	173.64	204.03
LFP000110	RING PISTON (SET)	183.56	215.68
LFP000110P	RING PISTON (SET)	59.53	69.95
LGC000280	CAMSHAFT-ENGINE	94.81	111.40
LGC000560	RH CAMSHAFT 4.6 V8 75 V8 & MGZT260	21.28	25.00
LGC000570	LH CAMSHAFT 4.6 V8 75 V8 & MGZT260	21.28	25.00
LGC10205	CAMSHAFT ASSY-ENGINE EXHAUST	154.71	181.78
LGC106010	CAMSHAFT ASSY-ENGINE INLET	150.04	176.30
LGC106960	CAMSHAFT-ENGINE	173.07	203.36
LGC107430	CAMSHAFT ASSY-ENGINE	ENQUIRE	
LGH10029	VALVE-CYLINDER HEAD	22.44	26.37
LGH10029LP	VALVE-INLET-CYL HEAD	11.28	13.25
LGH10064	VALVE-CYLINDER HEAD INLET	26.16	30.74
LGH101180	VALVE-CYLINDER HEAD EXHAUST	27.66	32.50
LGH101180P	VALVE-CYLINDER HEAD EXHAUST	6.59	7.74
LGH101190	VALVE-CYLINDER HEAD	29.61	34.79
LGH101190LP	VALVE - EXHAUST	17.02	20.00
LGH101300	VALVE-CONTROL	105.28	123.70
LGH101350	VALVE-VARIABLE TIMING HYDRAULIC CO	128.36	150.82
LGH101360	VALVE-EXH-CYL HEAD	33.07	38.86
LGJ10034	GUIDE-CYLINDER HEAD VALVE	20.93	24.59
LGJ10034LP	GUIDE-VALVE-CYL HEAD	3.56	4.18
LGJ101060	GUIDE-CYLINDER HEAD VALVE	7.75	9.11
LGK10088	INSERT-INLET VALVE SEAT-CYLINDER HEAD	4.01	4.71
LGK10089	INSERT-CYLINDER HEAD EXH VALVE SEAT	4.58	5.38
LGK101140	INSERT-INLET VALVE SEAT-CYLINDER HEAD	10.32	12.13

Part Number	Description	Price £ Ex VAT	Price £ Inc VAT
LGK101150	INSERT-CYLINDER HEAD EXH VALVE SEAT	3.42	4.02
LGK101160	INSERT-INLET VALVE SEAT-CYLINDER HEAD	2.98	3.50
LGK101170	INSERT-CYLINDER HEAD EXH VALVE SEAT	3.55	4.17
LGL10008	SPRING-CYLINDER HEAD VALVE	3.68	4.32
LGL100460	SPRING-CYLINDER HEAD VALVE	4.14	4.86
LGN10004	COLLET-CYLINDER HEAD VALVE	0.63	0.74
LGR000050	TAPPET-ENGINE VALVE HYDRAULIC	19.18	22.54
LGR000050P	TAPPET-ENGINE VALVE HYDRAULIC	8.94	10.50
LGR100330	TAPPET-ENGINE VALVE HYDRAULIC	19.52	22.94
LHR100440P	CAM FOLLOWER'A'SERIES	1.62	1.90
LHG000010	USE LHG000010 & LHH100480		
LHB101190	PULLEY-TIMING BELT DRIVEN	20.93	24.59
LHB101230	PULLEY-CAMSHAFT	13.27	15.59
LHB101330	PULLEY-TIMING BELT DRIVEN	157.02	184.50
LHB101360	PULLEY-TIMING BELT DRIVEN	17.79	20.90
LHG000010	PULLEY-CRANKSHAFT	130.89	153.80
LHG100750LP	CRANSHAFT PULLEY / DAMPER ASSY	108.94	128.00
LHM100480	GEAR-CRANKSHAFT TIMING DRIVE	14.44	16.97
LHM508	SYNCHRO ASSY-3/4	99.42	116.82
LHM595	SYNCHRO ASSY-5TH	106.86	125.56
LHN000070	CHAIN-TIMING	44.43	52.21
LHN10015EVA	BELT-TIMING	14.57	17.12
LHN10016	TIMING BELT 2.0 MPI	26.48	31.11
LHN10016P	TIMING BELT 2.0 MPI	16.81	19.75
LHN10022EVA	BELT-DRIVE-TIMING	7.93	9.32
LHN10029	BELT-ENGINE TIMING	51.93	61.02
LHN10029P	BELT-ENGINE TIMING	29.95	35.19
LHN100320EVA	BELT-ENGINE TIMING	52.06	61.17
LHN100320EVA	TIMING BELT	30.20	35.49
LHN100370EVA	BELT-DRIVE-TIMING	24.78	29.12
LHN100370EVA	BELT-DRIVE-TIMING	12.77	15.00
LHN100390	OE* TIMING BELT LANDROVER	35.87	42.05
LHN100390K	TIMING BELT NON AUTO TENSIONING	34.50	40.54
LHN100390P	TIMING BELT PETROL 1.8K	15.96	18.75
LHN100400	BELT-ENGINE TIMING	31.18	36.64
LHN100400P	BELT-ENGINE TIMING	20.42	23.99
LHN100410	BELT-ENGINE TIMING	54.94	64.55
LHN100410P	BELT-ENGINE TIMING	46.45	51.07
LHN100420	BELT-ENGINE TIMING	43.35	50.94
LHN100420P	BELT-ENGINE TIMING	34.86	40.96
LHN100460EVA	BELT-TIMING	39.58	46.51
LHN100460EVA	TIMING BELT	33.18	38.99
LHN100560	BELT-ENGINE TIMING 1.8K (AUTO TEN)	32.48	40.28
LHN100560P	BELT-ENGINE TIMING 1.8K (AUTO TEN)	18.51	21.75
LHN100690	BELT-ENGINE TIMING	63.04	74.07
LHN100690P	BELT-ENGINE TIMING	56.51	66.40
LHN100730	BELT-ENGINE TIMING	13.49	15.85
LHN100760	OE*TIMING BELT DIESEL 112 TEETH	60.83	71.48
LHN100760P	TIMING BELT DIESEL 112 TEETH	18.56	21.81
LHN100840	CHAIN-TIMING-ENGINE	62.31	73.21
LHP10015	TENSIONER-TIMING BELT	36.59	42.99
LHP10015P	TENSIONER-TIMING BELT	19.53	22.95
LHP10016	TENSIONER-T/BELT	40.78	47.92
LHP10016P	TENSIONER-T/BELT	32.34	38.00
LHP100550	TENSIONER-TIMING BELT	37.47	43.67
LHP100550P	TENSIONER-TIMING BELT	16.17	19.00
LHP100840A	TENSIONER-T/BELT	16.69	19.46
LHP100840P	TENSIONER-T/BELT	16.17	19.00
LHP100900	TENSIONER-TIMING BELT	30.61	35.97
LHP100940	TENSIONER-T/BELT	36.63	43.04
LHR10005	SPRING & SLEEVE ASSY	8.68	10.20
LHT100060	BOLT-SHOULDERED-TIMING BELT COVER	3.62	4.25
LHV100160A	IDLER-TIMING BELT	51.25	60.22
LHV100160AP	IDLER-TIMING BELT	42.98	50.50
LIB100000EVA	BELT-ENGINE BALANCE SHAFT DRIVE	23.69	27.84
LIB100000EVA	TIMING BELT	12.86	15.11
LJQ000030	USE UAM3797L		
LJQ10001L	USE LJQ10001LP		
LJQ10001LP	OE*TIMING COVER GASKET	0.19	0.22
LJQ10001LP	TIMING COVER GASKET	0.15	0.18
LJQ100003	SEAL-COOLANT PUMP	0.57	0.67
LJQ100003L	OE*TIMING COVER GASKET	0.37	0.43
LJQ100003LP	TIMING COVER GASKET	0.30	0.35
LJQ10007	SEAL	4.89	5.75
LJQ10007L	OE*TIMING COVER GASKET	6.24	7.33
LJQ10007LP	TIMING COVER GASKET	2.30	2.70
LJQ10008	SEAL	7.09	8.33
LJQ10008L	OE*TIMING COVER GASKET	6.52	7.66
LJQ10008LP	TIMING COVER GASKET	3.56	4.18
LJQ100920	USE LJQ100920SLP		
LJQ100920SLP	SEAL-VARIABLE VALVE TIMING HYDRAULIC	CON.2.72	3.20
LJQ100950	SEAL-VARIABLE VALVE TIMING HOUSING	6.91	8.12
LJQ100950P	SEAL-VARIABLE VALVE TIMING HOUSING	4.59	5.39
LJQ100950SLP	SEAL-VARIABLE VALVE TIMING HOUSING	6.94	8.15
LJR000110	COVER ASSY-REAR TIMING BELT	6.10	7.17
LJR000120	COVER ASSY-UPPER REAR TIMING COVER	6.45	7.58
LJR104000	COVER ASSY-UPPER FRONT TIMING BELT	26.75	31.43
LJR104000T0	NEW TAKE OFF-TIMING BELT COVER	8.08	9.49
LJR104320	COVER ASSY-UPPER REAR TIMING COVER	26.16	30.74
LJR104350	COVER-LOWER FRONT TI	ENQUIRE	
LJR104760	COVER ASSY-UPPER FRONT TIMING BELT	26.02	30.57
LJR104770	COVER ASSY-UPPER FRONT TIMING BELT	11.87	13.95
LJR104800	USE LJR000110		
LJZ100680	SHAFT ASSY-VARIABLE VALVE TIMING INL	ENQUIRE	
LKB000281	MANIFOLD-ENGINE UPPER INLET	156.07	183.38
LKB107030	MANIFOLD-ENGINE LOWER INLET	142.57	167.52
LKB107031	MANIFOLD-ENGINE LOWER INLET	140.73	165.36
LKB107060	MANIFOLD-INLET-ENG	64.68	76.00
LKB107560	MANIFOLD ASSY-INLET	177.97	209.11
LKB109290	USE LKB109291		

Part Number	Description	Price £ Ex VAT	Price £ Inc VAT
LKB109290 T0	USE LKB109291 NEW T-0		
LKB109291	MANIFOLD ASSY - INLET	204.13	239.85
LKB109291 NEW T-0	INLET MANIFOLD ASSY	ENQUIRE	
LKC10200	USE LKC10200L OR RP1054 & RP1055		
LKC10200L	OE*MANIFOLD ASSY - EXHAUST - 6 STUD TYPE	206.07	242.13
LKC103240	EXHAUST MANIFOLD 4 STUD TYPE	183.57	215.69
LKG100300	OE*EXHAUST MANIFOLD GASKET PETROL	6.01	7.06
LKG100300P	EXHAUST MANIFOLD GASKET PETROL	3.40	4.00
LKG100551	GASKET	5.96	7.00
LKG100551P	MANIFOLD GASKET	4.08	4.79
LKJ10028EVA	GASKET-MANIFOLD	2.17	2.55
LKJ10028EVA	GASKET-MANIFOLD	1.28	1.50
LKJ10029EVA	GASKET-INLET MANIFOLD	3.56	4.18
LKJ10029EVA	GASKET-INLET MANIFOLD	1.96	2.30
LKJ100821	GASKET-INLET MANIFOLD	3.03	3.56
LKJ100821P	GASKET-INLET MANIFOLD	2.25	2.64
LKJ100860	GASKET-INLET MANIFOLD-UPPER TO LOWER	2.82	3.31
LKJ101110LP	INLET MANIFOLD GASKET PETROL	3.40	4.00
LKJ101110SLP	GASKET-INLET MANIFOLD	6.16	7.24
LL1171	BATTERY ISOLATOR SWITCH	5.96	7.00
LL1316	LUMENITION KIT DEFENDER 2 1/4 PETROL	200.85	236.00
LLH102210A	HOSE-MANIFOLD	8.74	10.27
LLH102280	HOSE-BREATHR-CAM CVR	11.82	13.89
LLH102380	HOSE-BREATHR-CAM CVR	8.36	9.82
LLH102390	HOSE-BREATHR-CAM CVR	11.87	13.95
LLH102801	HOSE-CAMSHAFT COVER TO THROTT/BODY	9.76	11.47
LN10081	NIPPLE-GREASE	0.50	0.59
LNN100000	SOLENOID-CONTROL VALVE	22.80	26.79
LPP000030	OIL PUMP ASSY	236.55	277.95
LPP000030P	OIL PUMP ASSY	67.23	79.00
LPP000130EVA	PUMP ASSY-ENGINE OIL	66.69	78.36
LPP000130EVA	PUMP ASSY-ENGINE OIL	49.95	58.69
LPP000132EVA	PUMP ASSY-ENGINE OIL	208.42	244.89
LPP000132EVA	OIL PUMP	73.19	86.00
LPP000139EVA	USE GLP139		
LPP000142EVA	USE GLP142		
LPP10051EVA	PUMP ASSY-ENGINE OIL	159.18	187.04
LPP10051EVA	PUMP ASSY-ENGINE OIL	73.19	86.00
LPP101290	USE LPP101290SLP		

LUC100290SLP-MS35R

Part Number	Description	Price £ Ex VAT	Price £ Inc VAT
LUC100290SLP	SEAL-CAMSHAFT OIL	4.65	5.46
LUC100290SLPP	SEAL-OIL-CAMSHAFT	2.64	3.10
LUD100040	OIL FILLER CAP SEAL 2.0 MPI	3.05	3.58
LUD100040P	OIL FILLER CAP SEAL 2.0 MPI	1.28	1.50
LUF000050SLP	SEAL-CRANKSHAFT REAR OIL	21.96	25.80
LVB000320	GASKET-CYLINDER HEAD	34.74	40.82
LVB000320SLP	USE LVB000320		
LVB000320SLPP	CYLINDER HEAD GASKET PETROL	15.96	18.75
LVB101630	2.5 V6 CYLINDER HEAD GASKET ONLY	24.92	29.28
LVB101630P SET	2.5 V6 CYLINDER HEAD GASKET SET	85.11	100.00
LVB500190	MULTI LAYER STEEL HEAD GASKET	48.94	57.50
LVB500190A	MLS GASKET	55.43	65.13
LVB500190P1	MULTI LAYER STEEL HEAD GASKET	22.77	26.75
LVF100290	GASKET-CRANKCASE OIL SUMP	20.88	24.53
LVF100290P	GASKET-CRANKCASE OIL SUMP	8.08	9.49
LVG100230	USE LVG100330		
LVG100330	OE*OIL PUMP HOUSING GASKET PETROL	2.36	2.77
LVH10010	OE*OIL FILTER ADAPTOR GASKET PETROL	0.88	1.03
LVJ000040	GASKET-CRANKCASE TO G/BOX MOUNT/PLA	0.85	1.00
LVJ100140	GASKET - TUBE	0.37	0.43
LVP100360EVA	GASKET-CAMSHAFT COVER	6.45	7.58
LVP100390	GASKET-CAMSHAFT COVER	14.97	17.59
LVP100390P	GASKET-CAMSHAFT COVER	5.32	6.25
LVP100580	GASKET-CAMSHAFT COVER	1.48	1.74
LVP100630	CAMSHAFT COVER GASKET	11.71	13.76
LVP100630LP	CAMSHAFT COVER GASKET PETROL	5.53	6.50
LVP100630P	USE LVP100630LP		
LVQ000070	SET-ENGINE GASKET	32.46	38.14
LVQ000070P	CONVERSION SET	11.87	13.95
LVQ000090	USE LVQ000091SLP		
LVQ000090P	MLS USE LVQ000091P MLS		
LVQ000090SLP	USE LVQ000091SLP		
LVQ000090SLPP	USE LVQ000091SLPP		
LVQ000091P	MLS MULTI LAYER STEEL HEAD GASKET SET	49.79	58.50
LVQ000091SLP	SET-CYLINDER HEAD GASKET	110.12	129.39
LVQ000091SLPP	SET-CYLINDER HEAD GASKET	39.96	46.95
LVQ000100SLP	USE LVQ000101SLP		
LVQ000101P	MLS SET-CYLINDER HEAD GASKET	49.79	58.50
LVQ000101SLP	USE LVQ000102SLP		
LVQ000101SLPP	SET-CYLINDER HEAD GASKET	42.51	49.95
LVQ10012EVA	GASKET	5.75	6.76
LVQ100990P	CYLINDER HEAD GASKET SET	95.00	111.63
LVQ101010	SET-CYLINDER HEAD GASKET	82.81	97.30
LVQ101010P	SET-CYLINDER HEAD GASKET 2.0 L SERIES	28.94	34.00
LVQ101240	SET-ENGINE GASKET	116.18	136.51
LVQ101240P	SET-ENGINE GASKET	66.38	78.00
LVQ701137EVA	CYLINDER HEAD GASKET SET	59.95	70.44
LVW000010	KIT-BEARING LADDER LIQUID GASKET	16.01	18.81
LVW000108EVA	KIT-BEARING LADDER LIQUID GASKET	9.82	11.54
LBX100070	KIT-SEAL	27.21	31.97
LXS100080	HYDRAULIC CONTROL UNIT ASSY-VARIABLE	125.61	147.59
LVX100140	CAMSHAFT ASSY-ENGINE INLET	467.20	548.96
LVX100150	CAMSHAFT ASSY-ENGINE INLET	445.02	522.90
LYB100510	PLUG-TAPER THREAD		ENQUIRE
LYF000020	WASHER	0.45	0.53
LYF100051	WASHER	3.37	3.96
LYF101440	WASHER	4.41	5.18
LYG10015	SCREW	0.58	0.68
LYG10040L	SCREW	0.38	0.45
LYG101460	BOLT-ADHESIVE-PATCH	1.69	1.99
LYH100470	NUT	4.72	5.55
LYP10003	SCREW-FLANGED HEAD	0.43	0.51
LYP10005	SCREW		ENQUIRE
LYP10008	USE LYP10008L		
LYP10008L	OE*SCREW	1.66	1.95
LYR000021	STUD	1.43	1.68
LYU000010	DOWEL-PIN	0.75	0.88
LYU100290	DOWEL-RING	0.45	0.53
LZB100271	KIT	3.69	4.34
LZB100271P	CAM SEAL	2.30	2.70
LZN10001	INSERT-SCREW IN	1.31	1.54
LZN100220	INSERT	5.88	6.91
MAH100840	HOSE-FUEL-PIPE	12.86	15.11
MAH101070	HOSE-MOULDED-VENT FUEL SYSTEM	5.36	6.30
MAT8	FOOTWELL AMTS-MGB(4SYNCHRO)	21.70	25.50
MB10	FRONT VALANCE-LOWER	42.98	50.50
MB100	MTG.BRKT.RR SUSPEN BUMP STOP MGB	6.77	7.95
MB101	REAR CORNER	9.95	11.69
MB104L	FINISHER-DOOR SHUT FACE MGB LH	6.94	8.15
MB104R	FINISHER-DOOR SHUT FACE MGB RH	6.94	8.15
MB11	FRONT VALANCE MGB *NOT OE*	42.51	49.95
MB12	FRONT VALANCE-MGB-RUB BUMPER TYPE	46.38	54.50
MB15L	LHF WING LOWER REPAIR MGB	29.79	35.00
MB15R	RHF WING LOWER REPAIR MGB	29.49	34.65
MB16L	LHF 1/4 LOWER REPAIR PANEL MGB	19.56	22.98
MB16R	RHF 1/4 LOWER REPAIR PANEL MGB	17.45	20.50
MB17L	REINF W/ARCH PEDAL BOX	11.48	13.49
MB17R	REINF W/ARCH PEDAL BOX	11.48	13.49
MB19L	S/PLATE	1.83	2.15
MB19R	S/PLATE	1.83	2.15
MB19SL	SPLASH PLATE-LH S/S	7.23	8.50
MB19SR	SPLASH PLATE-RH S/S	7.23	8.50
MB20L	S/PANEL EXT. LH	2.34	2.75
MB20R	S/PANEL EXT. RH	2.34	2.75
MB21AL	FLOOR PANEL 4 SYNCH.67 ON LH MGB	42.51	49.95
MB21AR	FLOOR PANEL 4 SYNCH.67 ON RH MGB	42.51	49.95
MB21L	FLOOR PANEL 3 SYNC	73.83	86.75

WEB ORDER - YOU SHOP - WE DELIVER. www.rimmerbros.co.uk

Part Number	Description	Price £ Ex VAT	Price £ Inc VAT
MB21R	RH FLOOR PANEL '62-67 MGB	73.83	86.75
MB22L	STEP SILL REPAIR-FRONT 4FT MGB LH	20.38	23.95
MB22R	STEP SILL REPAIR-FRONT 4FT MGB RH	20.38	23.95
MB23L	INNER SILL-LH MGB	20.42	23.99
MB23R	INNER SILL RH MGB	20.42	23.99
MB24L	CASTLE SECTION-LH	35.73	41.98
MB25	CASTLE SECTION REPAIR-2FT-MGB	10.43	12.26
MB26L	SILL END FILLER-LH	1.79	2.10
MB26R	SILL END FILLER-RH	1.79	2.10
MB27L	TOP REPAIR PLATE FOR MB17 MGB RH	7.45	8.75
MB27R	TOP REPAIR PLATE FOR MB17 MGB LH	7.45	8.75
MB28L	STAINLESS STEEL OVERSILL MGB LH	25.49	29.95
MB28R	STAINLESS STEEL OVERSILL MGB RH	25.49	29.95
MB29	STAINLESS STEEL SILL FINISHER MGB	13.40	15.75
MB30Z	JACKING POINT REINFORCEMENT MGB	2.51	2.95
MB31	CROSSMEMBER REPAIR	2.34	2.75
MB32	SILL JACKING POINT MGB	8.08	9.49
MB36L	WING REPAIR-REAR QUARTER-LH	18.08	21.24
MB36R	WING REPAIR-REAR QUARTER-RH	18.08	21.24
MB37L	WING REPAIR-REAR LH	69.36	81.50
MB37R	WING REPAIR-REAR RH	69.36	81.50
MB40	BOOT FLOOR MGB(REMAN)	68.04	79.95
MB41	REAR VALANCE REPAIR(CB)	58.68	68.95
MB45	REAR LOWER PANEL MGB'74>	67.19	78.95
MB46L	DOOR BOTTOM REPAIR MGB LH	18.51	21.75
MB46R	DOOR BOTTOM REPAIR MGB RH	18.51	21.75
MB50L	BOOT FLOOR EXTENSION MGB LH	10.64	12.50
MB50R	BOOT FLOOR EXTENSION MGB RH	10.64	12.50
MB51	INNER FLITCH TOP REPAIR MGB	14.04	16.50
MB52L	DASH SIDE LOWER REPAIR MGB LH	7.23	8.50
MB52R	DASH SIDE LOWER REPAIR MGB RH	7.23	8.50
MB53	REAR OUTER VALANCE MGB RDSTR CHR.	92.73	108.96
MB55L	REAR WH/ARCH OUTER REPAIR MGB LH	14.89	17.50
MB55R	REAR WH/ARCH OUTER REPAIR MGB RH	14.89	17.50
MB56L	CHASSIS REPAIR-RR.R/S/SPRING-LH	57.83	67.95
MB56R	CHASSIS REPAIR-RR.R/S/SPRING-RH	57.83	67.95
MB57L	REAR CHASSIS REPAIR MGB RBR.BPR. LH	60.85	71.50
MB57R	REAR CHASSIS REPAIR MGB RBR.BPR. RH	60.85	71.50
MB58AL	SPRING PLATE MGB RBR.BPR. LH	11.87	13.95
MB58AR	SPRING PLATE MGB RBR.BPR. RH	11.87	13.95
MB58L	CLOSING PANEL-LH	12.34	14.50
MB58R	CLOSING PANEL-RH	12.34	14.50
MB59L	'B'POST LOWER REPAIR-LH	7.62	8.95
MB59R	'B'POST LOWER REPAIR-RH	7.62	8.95
MB60L	RR INR. W/ARCH OUTER SECTION MGB LH	60.85	71.50
MB60R	RR INR. W/ARCH OUTER SECTION MGB RH	60.85	71.50
MB61	REAR VALANCE MGB ROADSTER RBR.BPR.	79.96	93.95
MB62	REAR VALANCE MGB GT RBR.BPR.	79.11	92.95
MB63	SUPPORT RADIATOR DUCT MGB	13.40	15.75
MB64	RADIATOR DUCT MGB	41.28	48.50
MB65	REINF. BONNET LOCK PLATFORM MGB	10.64	12.50
MB66	BONNET LOCK PLATFORM MGB	28.04	32.95
MB67L	DASH SIDE 14" MGB LH	24.64	28.95
MB67R	DASH SIDE 14" MGB RH	24.64	28.95
MB68L	DASH SIDE REPAIR MGB LH	11.02	12.95
MB68R	DASH SIDE REPAIR MGB RH	11.02	12.95
MB70L	MTG BRKT WINDOW CHANNEL LH MGB	9.32	10.95
MB70R	BRACKET-RH UNIVERSAL	9.32	10.95
MB71L	FLOOR OUTER REPAIR LH MGB	19.15	22.50
MB71R	FLOOR OUTER REPAIR RH MGB	19.15	22.50
MB76	REAR VALANCE MGB GT CHROME BPR.	91.02	106.95
MB77	REAR INNER W/ARCH INNER REPAIR MGB	23.79	27.95
MB86SL	REAR BUMPER INFILL S/STEEL MGB LH	3.19	3.75
MB86SR	REAR BUMPER INFILL S/STEEL MGB RH	3.19	3.75
MB88L	WINDOW CHANNEL MGB LH	18.68	21.95
MB88R	WINDOW CHANNEL MGB RH	18.68	21.95
MB89	DOOR SEAL RETAINER S/STEEL MGB	10.17	11.95
MB90L	B POST ASSY. MGB LH	34.00	39.95
MB90R	B POST ASSY.MGB RH	34.00	39.95
MB91L	HEELBOARD EXTENSION MGB LH	9.79	11.50
MB91R	HEELBOARD EXTENSION MGB RH	9.79	11.50
MB93	BATTERY COVER (12V BATTERY) MGB	11.87	13.95
MB94L	PAINTED BRAKE DISC COVER MGB LH	5.74	6.74
MB94R	PAINTED BRAKE DISC COVER MGB RH	5.74	6.74
MB94SL	BRAKE DISC COVER S/STEEL MGB LH	11.02	12.95
MB94SR	BRAKE DISC COVER S/STEEL MGB RH	11.02	12.95
MB95	SPARE WHEEL CLAMP ROSTYLE WHEELS	9.57	11.24
MB96	SPARE WHEEL CLAMP WIRE WHEELS MGB	9.57	11.24
MB97L	INNER WING REPAIR-LH	29.36	34.50
MB97R	INNER WING REPAIR-RH	29.36	34.50
MB98	EXHAUST MTG.BRKT. REAR MGB	3.62	4.25
MB99	AXLE DIFF. COVER (TUBE)	47.66	56.00
MBK1001L	MGB SILL KIT-LH	83.40	98.00
MBK1001R	MGB SILL KIT-RH	83.40	98.00
MBK1003L	SILL PANEL KIT-LH	41.28	48.50
MBK1003R	SILL PANEL KIT-RH	41.28	48.50
MDQ100040	MOTOR-MPI STEPPING	65.16	76.56
MDQ100170	MOTOR-MULTI POINT INJECTION STEPPING	45.50	53.46
MDY100040	WASHER-SEALING		ENQUIRE
MDY100080	WASHER-SEALING	1.02	1.20
MEK000030	SENSOR-TEMPERATURE OE	26.36	30.97
MEK000030P	SENSOR ASSY AFTERMARKET	7.00	8.23
MEK100060	SENSOR-TEMPERATURE	11.83	13.90
MEK100160	OE*SENSOR ASSY	11.44	13.43
MHB000080	THROTTLE BODY ASSY TBI	118.30	139.00
MHB000080BODY	THROTTLE BODY LESS POTENTIOMETER		ENQUIRE
MHB000090	BODY ASSY-THROTTLE	90.41	106.23
MHB000261	THROTTLE BODY ASSY TBI	179.76	211.22
MHB000261P	THROTTLE BODY ASSY TBI	120.00	141.00
MHH100280	PIPE-INLET MANIFOLD VACUUM	0.92	1.08

Part Number	Description	Price £ Ex VAT	Price £ Inc VAT
MHK10006	SENSOR-OXYGEN MULTI POINT INJECTION	119.56	140.48
MHK10006P	SENSOR-OXYGEN MULTI POINT INJECTION		ENQUIRE
MHK100490	USE MHK100600		
MHK100520	SENSOR-MULTI POINT INJEC AMBIENT AIR	27.80	32.67
MHK100600	SENSOR	147.38	173.17
MHK100820	SENSORMULTI POINT INJECT MANIFOLD PR77.36		90.90
MHK100820P	SENSORMULTI POINT INJECT MANIFOLD PR51.02		59.95
MHK100840	SENSOR-OXYGEN MULTI POINT INJECT	123.76	145.42
MHK100840P	SENSOR-OXYGEN MULTI POINT INJECT	61.28	72.00
MHK101070	SENSOR ASSY-AIRFLOW MULTI POINT INJE157.80		185.42
MHK101070P	SENSOR ASSY-AIRFLOW MULTI POINT INJE		ENQUIRE
MHK101086	SENSOR-OXYGEN MULTI POINT INJECTION	99.33	116.71
MHK101086P	LAMBDA SENSOR		66.13 77.70
MHK101130	USE MHK101130SLP		
MHK101130SLP	SENSOR ASSY		179.05 210.38
MHK101190P	SENSOR		41.28 48.50
MJN10032	RAIL-MULTI POINT INJECT FUEL DISTRIB		41.43 48.68
MJQ10003	PUMP ASSY-FUEL INJECTION		ENQUIRE
MJY100430	INJECTOR-FUEL MULTI POINT INJECTION		69.23 81.35
MJY100580	INJECTOR-FUEL MULTI POINT INJECTION		44.72 52.55
MJY100640	INJECTOR-FUEL MULTI POINT INJECTION		35.32 41.50
MKC104001	USE MKC104001E		
MKC104001E	ECU-FUEL/IGNITION SURCHARGE	227.13	266.88
MKC104112	USE MKC104112E		
MKC104112E	ECU-FUEL/IGNITION SURCHARGE	233.93	274.87
MKG100250	KIT-O RING		9.16 10.76
MKG100270	KIT-INJECTOR-MPI		202.21 237.60
MKG100270P	INJECTOR		155.73 182.98
MKW10016	REGULATOR-MU/POINT INJECT FUEL PRE		33.50 39.36
MLB10028P	THROTTLE BODY ASSY		160.00 188.00
MLFC2003A	MINI 06 FOG LAMP ASSY		35.45 41.65
MLFC2003U	MINI 06 FOG LAMP UNIT		35.45 41.65
MLFL1602U	PARK/SIGNAL LAMP UNIT N/S		14.39 16.91
MLFL2001A	FOG LAMP ASSY N/S		35.45 41.65
MLFL2001U	FOG LAMP UNIT (ECE & SAE) N/S		28.36 33.32
MLFR1602U	PARK/SIGNAL LAMP UNIT O/S		14.39 16.91
MLFR2001A	FOG LAMP ASSY O/S		35.45 41.65
MLFR2001U	FOG LAMP UNIT (ECE & SAE) O/S		28.36 33.32
MLHL1112ARHD	N/S HEADLAMP UNIT-ECEC W/S MOTOR		138.76 163.04
MLHL1116ARHD	N/S HEADLAMP UNIT-ELEC W/S MOTOR		138.76 163.04
MLHR1112ARHD	O/S HEADLAMP UNIT-ECEC W/S MOTOR		138.76 163.04
MLHR1116ARHD	O/S HEADLAMP UNIT-ELEC W/S MOTOR		138.76 163.04
MLN001	TRILOCK W/NUT SET (MGB)		17.66 20.75
MLPL2502U	SIDE TRIM BASE BEZEL N/S		7.94 9.33
MLPR2502U	SIDE TRIM BASE BEZEL O/S		7.94 9.33
MLRL1902U	MINI TAIL LAMP UNIT N/S		46.90 55.11
MLRL1906U	MINI 04 TAIL LAMP UNIT N/S		39.83 46.80
MLRR1902U	MINI TAIL LAMP UNIT O/S		46.90 55.11
MLRR1906U	MINI 04 TAIL LAMP UNIT O/S		39.83 46.80
MLSC1403AC	MINI SIDE LAMP ASSY - CLEAR LENS		

Part Number	Description	Price £ Ex VAT	Price £ Inc VAT
MS36	S/S STRIP FOR MS33/34	18.68	21.95
MS37L	SILL-OUTER-LH	27.66	32.50
MS37R	SILL-OUTER-RH	29.95	35.19
MS39L	SILL-OUTER-LH	27.66	32.50
MS39R	SILL-OUTER-RH	27.66	32.50
MS40L	FRT.CHASSIS LEG FRT.REP.MIDG/SPRT LH	34.00	39.95
MS40R	FRT.CHASSIS LEG FRT.REP.MIDG/SPRT RH	34.00	39.95
MS42	RADIATOR TRAY MIDGET & SPRITE	10.64	12.50
MS43L	DOOR BOTTOM REPAIR MIDG/SPRT. LH	15.75	18.51
MS43R	DOOR BOTTOM REPAIR MIDG/SPRT. RH	15.75	18.51
MS44L	BOOT FLOOR TO WING MIDG/SPRT LH	10.00	11.75
MS44R	BOOT FLOOR TO WING MIDG/SPRT RH	10.00	11.75
MS45L	W/ARCH INNER REPAIR-LH	24.26	28.51
MS45R	W/ARCH INNER REPAIR-RH	24.26	28.51
MS47L	OUTER FOOTWELL MIDG/SPRT. LH	10.00	11.75
MS47R	OUTER FOOTWELL MIDG/SPRT. RH	10.00	11.75
MS48	CROSSMEMBER + JACK POINT MID/SPR.	13.83	16.25
MS51L	INR.W/ARCH REP.OUTER SECT.MID/SPR.LH	26.81	31.50
MS51R	INR.W/ARCH REP.OUTER SECT.MID/SPR.RH	26.81	31.50
MS52	RAD.COWL MIDGET & SPRITE	77.02	90.50
MS54	RAD SPLASH SHIELD MIDG/SPRT.LH	35.70	41.95
MS55	RAD SPLASH SHIELD MIDG/SPRT.RH	35.70	41.95
MS56	BONNET ASSY.MIDGET & SPRITE	263.83	310.00
MSR10009	PUMP ASSY-FUEL INJECTION	ENQUIRE	
MSR10009P	PUMP-FUEL INJECTION	1078.33	1267.04
MSR10010	PUMP ASSY-FUEL INJ	899.67	1057.11
MSR10013	PUMP ASSY-FUEL INJ	1131.17	1329.12
MSR10014	PUMP ASSY-FUEL INJ	1177.17	1383.17
MSR100200	PUMP ASSY-FUEL INJ	1395.68	1639.92
MSR100250	PUMP ASSY-FUEL INJ	1050.26	1234.06
MSR100260	PUMP ASSY-FUEL INJ	ENQUIRE	
MSR100280	PUMP ASSY-FUEL INJ	314.88	369.98
MSR100290	PUMP ASSY-FUEL INJ	1050.65	1234.51
MSR100310	USE MSR100310E		
MSR100310E	PUMP ASSY-FUEL INJECTION DIESEL	946.63	1112.29
MT8101	BOOT HINGES(PR)-MINI(CHROME)	11.90	13.98
MUC3610A	SEAL	33.33	39.16
MUN10001EVA	CARTRIDGE-DIESEL FUEL FILTER	7.90	9.28
MVF10001	BELT-TOOTHED FUEL INJECT PUMP DRIVE	30.39	35.71
MVF100070	CHAIN-TIMING-ENGINE	33.29	39.12
MYP100340	SCREW	0.28	0.33
MYP100340L	SCREW	0.38	0.45
MYP100610	SCREW-TAPTITE	0.76	0.89
NAD10042	USE NAD10042E		
NAD10042E	STARTER MOTOR M79 - EXCHANGE UNIT	250.92	294.83
	SURCHARGE	100.00	117.50
NAD10042P	USE NAD101320P		
NAD10050	USE NAD10050E		
NAD10050E	STARTER MOTOR - EXCHANGE	141.60	166.38
	SURCHARGE	100.00	117.50
NAD10050P	USE NAD101320P		
NAD100790E	STARTER MOTOR - EXCHANGE	134.54	158.08
	SURCHARGE	100.00	117.50
NAD100790P	STARTER MOTOR *NEW OUTRIGHT*	114.04	134.00
NAD101260	NEW T-O NEW STARTER MOTOR - TAKE OFF	80.85	95.00
NAD101320	USE NAD101320E		
NAD101320E	STARTER MOTOR - EXCHANGE	170.21	200.00
	SURCHARGE	100.00	117.50
NAD101320P	STARTER MOTOR *NEW OUTRIGHT*	102.13	120.00
NAD101340	USE NAD101340E		
NAD101340E	STARTER MOTOR - EXCHANGE	147.78	173.64
	SURCHARGE	100.00	117.50
NAD101340P	USE NAD101320P		
NAF000010	USE ADU5728		
NAF000010P	USE 134174		
NAM1290	WASHER	0.54	0.63
NAM1394	WASHER-SEALING	0.41	0.48
NAM2109	SPACER	ENQUIRE	
NAM3432	SPACER	ENQUIRE	
NAM3557	PAD-INSULATION	2.87	3.37
NAM3607EVA	CABLE-HANDBRAKE	13.31	15.64
NAM3607EVA	BRAKE CABLE	5.25	6.17
NAM3608EVA	CABLE-HANDBRAKE	5.71	6.71
NAM3608EVA	BRAKE CABLE	2.83	3.33
NAM3620	MOUNTING-ENGINE	30.42	35.74
NAM3959EVA	DAMPER ASSY REAR	33.49	39.35
NAM3959EVA	SPAX AS SPAX ADJ.SPRG.SEAT RR.STRUT	167.66	197.00
NAM4376EVA	JOINT-BALL-LOWER FRONT SUSPENSION	7.51	8.82
NAM4472EVA	DAMPER ASSY	34.53	40.57
NAM4484EVA	CYLINDER ASSY-BRAKE MASTER	ENQUIRE	
NAM4538EVA	CYLINDER ASSY-BRAKE MASTER	19.19	22.55
NAM4538EVA	WHEEL CYLINDER	8.51	10.00
NAM4539EVA	CYLINDER ASSY-BRAKE MASTER	18.97	22.29
NAM4539EVA	WHEEL CYLINDER	8.51	10.00
NAM4596EVA	CABLE-HANDBRAKE	7.19	8.45
NAM4600EVA	CABLE-HANDBRAKE	6.90	8.11
NAM4600EVA	BRAKE CABLE	4.17	4.90
NAM4798EVA	DAMPER ASSY REAR	ENQUIRE	
NAM5120EVA	STRUT-FRONT	41.55	48.82
NAM5216	EXPANSION TANK 2.0 EFI AND TURBO	12.77	15.00
NAM5529	USE SDB000364EVA		
NAM5554P	COIL SPRING-FRONT	40.85	48.00
NAM5603EVA	USE NAM5603EVA		
NAM5603EVA	BRAKE CABLE	6.47	7.60
NAM5604	USE NAM5604EVA		
NAM5604EVA	CABLE-HANDBRAKE	14.98	17.60
NAM5604EVA	BRAKE CABLE	11.88	13.96
NAM5645	WHEEL STUD	4.55	5.35
NAM6385	CLIP	0.84	0.99
NAM6450EVA	DISC-BRAKE(VENTILATED)	14.89	17.50
NAM6450EVA	UR EBC TURBO GROOVE BRAKE DISC *PAIR*	109.79	129.00

Part Number	Description	Price £ Ex VAT	Price £ Inc VAT
NAM6450EVA	DISC-BRAKE(VENTILATED)	18.08	21.24
NAM6691EVA	STRUT-REAR	32.70	38.42
NAM6857POLY	ANTI-ROLL BAR LINK & BUSH-POLY (EACH)	45.11	53.00
NAM6875	BUSH	0.52	0.61
NAM7554EVA	JOINT-BALL-LOWER FRONT SUSPENSION	17.84	20.96
NAM7554EVA	BALL JOINT	10.16	11.94
NAM7555EVA	JOINT-BALL	18.64	21.90
NAM7555EVA	BALL JOINT	10.16	11.94
NAM7562EVA	STRUT-FRONT	44.91	52.77
NAM7806	DISC-BRAKE(VENTILATED) **EACH**	33.50	39.36
NAM7806 ROS	ROSSINI PERFOR DISCS FRONT **PAIR**	119.15	140.00
NAM7806P	DISC-BRAKE(VENTILATED) **EACH**	17.87	21.00
NAM7806UR	TURBO GROOVED BRAKE DISC **PAIR**	109.79	129.00
NAM7914	CABLE ASSY-ACCEL	7.62	8.95
NAM7914P	ACCELERATOR CABLE MINI	3.32	3.90
NAM9003EVA	DAMPER ASSY	18.35	21.56
NAM9013	SPRING-COIL	0.44	0.52
NAM9017	BUSH-LOWER ARM-SUSP	1.80	2.12
NAM9077	NUT ASSY-ALLOY ROAD WHEELS	7.28	8.55
NAM9077K	WHEEL NUTS SET 12	77.50	91.06
NAM9226	STOP-BUMP-DAMPER	ENQUIRE	
NAM9348	SEAL	1.14	1.34
NAM9425EVA	JOINT-BALL-LOWER FRONT SUSPENSION	17.45	20.50
NAM9425EVA	LOWER BALL JOINT (EXC. 1.4 GTA)	7.66	9.00
NAM9462EVA	JOINT-BALL-LOWER FRONT SUSPENSION	15.90	18.68
NAM9462EVA	LOWER BALL JOINT RH 1.4 GTA	12.56	14.76
NAM9463EVA	JOINT-BALL-LOWER FRONT SUSPENSION	15.90	18.68
NAM9463EVA	LOWER BALL JOINT LH 1.4 GTA	8.51	10.00
NCC10001	PLUG-HEATER-IGNITION	21.29	25.02
NCC10001P	Y923U GLOW PLUG	13.78	16.19
NCC10002	PLUG-HEATER-IGNITION	5.40	6.35
NCC100050LP	GLOW PLUG DIESEL	7.02	8.25
NCC100050P	USE NCC100050LP		
NCC100080	PLUG-HEATER-IGNITION	6.76	7.94
NCC100080P	GLOW PLUG	5.95	6.99
NCC100100	PLUG-HEATER-IGNITION	30.15	35.43
NCC100120	PLUG-HEATER-IGNITION	19.78	23.24
NCC100120LP	GLOW PLUG	3.56	4.18
NCC100120P	USE NCC100120LP		
NCC8122PMA	GRIP-HANDBRAKE	8.31	9.76
NEC000120	COIL IGNITION	31.67	37.21
NEC000120P1	IGNITION COIL OEM	22.55	26.50
NEC000120T0	NEW GENUINE TAKE OFF UNUSED COIL ASSY201	25.20	29.75
NEC000130	COIL IGNITION	59.47	69.88
NEC100630	OE*COIL AND BRACKET ASSY-DRY-IGNITION	38.92	45.73
NEC100630P	COIL AND BRACKET ASSY-DRY-IGNITION	24.89	29.25
NEC100690	COIL-DRY IGNITION	113.27	133.09
NEC100710	COIL-QUADRUPLE OUTPUT IGNITION	98.22	115.41
NGC000020	KIT-HIGH TENSION LEADS IGNITION	65.15	76.55
NGC000020P	IGNITION LEAD SET KV6	31.06	36.50
NGC000030	SET-HIGH TENSION LEAD IGNITION	37.30	43.83
NGC000040	SET-HIGH TENSION LEAD IGNITION (2)	35.28	41.45
NGC000060P	TENSION LEAD IGNITION	15.11	17.75
NGC000070	SET-HIGH TENSION LEAD IGNITION	41.21	48.42
NGC000070P	SET-HIGH TENSION LEAD IGNITION	37.50	44.06
NGC000090	SET-HIGH TENSION LEAD IGNITION	41.21	48.42
NGC000090P	SET-HIGH TENSION LEAD IGNITION	24.95	29.32
NGC000090UR	USE RP1037K		
NGC000106EVA	LEAD ASSY-HIGH TENSION/KING IGNITION	6.47	7.60
NGC000152EVA	USE GHT152		
NGC000246EVA	SET-HIGH TENSION LEAD IGNITION	12.00	14.10
NGC000247EVA	PLUG LEAD SET- MG MONT/MAESTRO T	12.85	15.10
NGC10011EVA	SET-HIGH TENSION LEAD IGNITION	9.31	10.94
NGC102300EVA	KIT-H/T LEADS VITESSE 2L T SERIES ENG	6.81	8.00
NGC103060EVA	SET-HIGH TENSION LEAD IGNITION	19.34	22.72
NJD000110EVA	CAP-DISTRIBUTOR IGNITION	6.03	7.09
NJD000110EVA	USE GDC103		
NJD000143EVA	CAP-DISTRIBUTOR IGNITION	6.94	8.15
NJD000405EVA	CAP-DISTRIBUTOR IGNITION	18.65	21.91
NJD000405EVA	DISTRIBUTOR CAP	15.95	18.74
NJD10004EVA	CAP-DISTRIBUTOR IGNITION	23.31	25.06
NJD10010	OE-DISTRIBUTOR CAP PETROL	15.07	17.71
NJD10010P	DISTRIBUTOR CAP PETROL	4.21	4.95
NJD100130EVA	CAP-DISTRIBUTOR IGNITION	20.72	24.35
NJD100130EVA	DISTRIBUTOR CAP	16.95	19.92
NJD100140EVA	CAP-DISTRIBUTOR IGNITION	20.50	24.09
NJD100150	CAP-DISTRIBUTOR IGNITION	4.55	5.35
NJD100190	CAP-DISTRIBUTOR IGNITION	71.10	83.54
NJD100200	CAP-DISTRIBUTOR IGNITION	ENQUIRE	
NJE002123EVA	ROTOR HEAD ASSY-DISTRIBUTOR	2.15	2.53
NJE002130EVA	ROTOR HEAD ASSY-DISTRIBUTOR	5.55	6.52
NJE100050EVA	ROTOR HEAD ASSY-DISTRIBUTOR	8.52	10.01
NJE100050EVA	ROTOR ARM	4.75	5.58
NJE100060	ARM-ROTOR DISTRIBUTOR	12.84	15.09
NJE100060P	ROTOR ARM	8.53	10.02
NJE100070	ARM ASSY-ROTOR DISTRIBUTOR	9.29	10.92
NJE100070P	ROTOR ARM M SERIES 2LTR. MPI	2.51	2.95
NJE100070SLP	USE NJE100070		
NJE100100	ARM ASSY-ROTOR DISTRIBUTOR	15.92	18.71
NJI100030	ARM-ROTOR DISTRIBUTOR	17.56	20.63
NJI10001	BUSH-DRIVE SPINDLE DISTRIBUTOR	32.79	38.53
NJL000119EVA	SET-DISTRIBUTOR CONTACT	4.02	4.72
NLP000040	PLUG-SPARKING	3.56	4.18
NLP000040P	SPARK PLUG	2.25	2.64
NLP000050	PLUG-SPARKING	2.62	3.08
NLP000050P	SPARK PLUG	2.13	2.50
NLP000060	PLUG-SPARKING	3.71	4.36
NLP000090	PLUG-SPARKING	7.25	8.52
NLP000120	PLUG-SPARKING	9.87	11.60

Part Number	Description	Price £ Ex VAT	Price £ Inc VAT
NLP004352EVA	PLUG-SPARK	1.05	1.23
NLP100260EVA	PLUG-SPARK	4.10	4.82
NLP100260EVA	USE GSP6462		
NLP100290	PLUG-SPARKING	8.21	9.65
NLP100290P	PLUG-SPARKING	3.95	4.64
NNK10001	SENSOR-AIR INLET TEMP ENGINE-ELEC	31.18	36.64
NNN000060	ELECTRONIC CONTROL UNIT ENGINE	259.94	305.43
	SURCHARGE	267.25	306.97
NNN000100	ELECTRONIC CONTROL UNIT ENGINE	294.15	345.63
NNN000160	ELECTRONIC CONTROL UNIT ENGINE	389.92	458.16
NNN100743	ELECTRONIC CONTROL UNIT ENGINE	337.93	397.07
	SURCHARGE	339.63	399.07
NNN100783	ELECTRONIC CONTROL UNIT ENGINE	285.94	335.98
	SURCHARGE	275.00	323.13
NNP100810	PIPE-VACUUM-ENG ECU	ENQUIRE	
NRP1059	RADIATOR MGBV8'74>	114.04	134.00
NRP1059AL	RADIATOR-ALLOY-MGBGV8'74>	404.25	474.99
NRP1142	USE NRP1142P		
NRP1142P	RADIATOR MGB '67-'76	91.06	107.00
NRP1142UR	RADIATOR(HIGH FLOW)	166.81	196.00
NRP1154	USE NRP1154P		
NRP1154P	RADIATOR ASSY MGB'76>	108.94	128.00
NRP1154UR	RAD.MGB 76> HIGH FLOW	201.70	237.00
NSC000010	USE NSC000010SLP		
NSC000010SLP	SENSOR-CAMSHAFT ENGINE	109.44	128.59
NSC000310	SENSOR-CAMSHAFT ENGINE	57.17	67.17
NSC100320	SENSOR	ENQUIRE	
NSC100380	SENSOR	62.38	73.30
NSC100760	USE NSC100760SLP		
NSC100760SLP	CRANK SENSOR PETROL	69.64	81.83
NSC100760SLP	CRANKSHAFT SENSOR	ENQUIRE	
NSC100932	SENSOR-CAMSHAFT	54.47	64.00
NSC100960	SENSOR	106.56	125.21
NTC5858	OE*LOCKING RING EFI	3.87	4.55
NTC5858A	RING-RETAINING	10.10	11.87
NTC5859	OE*GASKET EFI PUMP	7.62	8.95
NTC5859A	SEAL-FUEL PUMP/TANK	8.54	10.03
NUC000124EVA	USE NUC000124EVA		
NUC000124EVA	SWITCH-OIL-PRESSURE R800 2.7 V6	9.95	11.69
NUC10003	OIL PRESSURE SWITCH	6.69	7.86
NUC10003P	OIL PRESSURE SWITCH	2.41	2.83
NUC100280	OIL PRESSURE SWITCH	12.75	14.98
NVG08041	NUT	1.45	1.70
NY108041L	USE FY108046		
NY112041	NYLOC NUT 12MM COARSE	0.77	0.90
NY210041	NUT M10 NYLOC	0.85	1.00
NY210047	USE NY210041		
OYG005296EVA	BOLT	0.16	0.19
OZQ000380EVA	USE GLB380		
PAI112150	PIN-ROLL	0.86	1.01
PAI16221	PIN-ROLL	0.84	0.99
PAK100380A	LABEL-WARN-COOLING	1.70	2.00
PAK100410A	USE PAK10038		

PCC103980SLP-PQS101272P

Part Number	Description	Price £ Ex VAT	Price £ Inc VAT
PCC103980SLP	RADIATOR ASSY	97.73	114.83
PCC103980SLPP	RADIATOR ASSY MINI SPI	68.94	81.00
PCC104080EVA	USE PCC104080SLP		
PCC104080SLP	RADIATOR ASSY	151.52	178.04
PCC104260EVA	USE PCC104260SLP		
PCC104260SLP	RADIATOR ASSY	149.62	175.80
PCC104260SLPP	RADIATOR	92.77	109.00
PCC104600EVA	RADIATOR ASSY	127.72	150.07
PCC104600EVA	RADIATOR	27.35	32.14
PCC104671	USE PCC104671		
PCC104671	RADIATOR-COOLING SYSTEM	138.53	162.77
PCC104671P	RADIATOR	64.97	76.34
PCC104680	RADIATOR ASSY	106.61	125.27
PCC104680P	RADIATOR	95.00	111.63
PCC105130EVA	RADIATOR ASSY	168.11	197.53
PCC105220	USE PCC105220SLP		
PCC105220SLP	RADIATOR ASSY	109.16	128.26
PCC105220SLPP	RADIATOR	83.22	97.78
PCC105500SLP	RADIATOR & INTERCOOLER	171.04	200.97
PCC105520	RADIATOR ASSY	135.85	159.62
PCC105520P	RADIATOR	97.02	114.00
PCC105740SLP	RADIATOR ASSY	188.92	221.98
PCC105900EVA	RADIATOR ASSY		ENQUIRE
PCC106340EVA	USE PCC106340SLP		
PCC106340SLP	RADIATOR ASSY	114.09	134.06
PCC107800	RADIATOR ASSY	204.69	240.51
PCC108351	RADIATOR ASSY		ENQUIRE
PCC113541SLP	RADIATOR ASSY	166.38	195.50
PCD000101EVA	USE GRC101		
PCD001111EVA	CAP-EXPANSION TANK P	2.53	2.97
PCD001111EVA	RADIATOR CAP 13 PSI	1.87	2.20
PCD100160	OE*PRESSURE CAP EXPANSION TANK	3.87	4.55
PCD100160P	PRESSURE CAP EXPANSION TANK	2.30	2.70
PCF000141	TANK-COOLING SYSTEM EXPANSION	24.35	28.61
PCG100230	MOUNT-RADIATOR RUBBER	0.58	0.68
PCG100231	MOUNT-RADIATOR RUBBER	0.40	0.47
PCH000244EVA	HOSE-RADIATOR	2.49	2.93
PCH000305EVA	HOSE-RADIATOR		ENQUIRE
PCH000305EVA	RAD.HOSE MGA/MGB	5.32	6.25
PCH000460EVA	HOSE-RADIATOR TOP COOLANT	9.05	10.63
PCH000498EVA	HOSE-RADIATOR	18.93	22.24
PCH000498EVA	RAD.BOTTOM HOSE MGB '72-'76	9.79	11.50
PCH000641EVA	USE PCH000641EVA		
PCH000641EVA	PCH000641EVA	10.21	12.00
PCH000645EVA	USE PCH000645EVA		
PCH000645EVA	HOSE-PUMP>PIPE	19.79	23.25
PCH001254EVA	USE 12A2178EVA		
PCH001710	HOSE	13.71	16.11
PCH002490	HOSE-BYPASS TO HEATER COOLANT	6.59	7.74
PCH002500	HOSE-EXPANSION TANK COOLANT	22.68	26.65
PCH002740	HOSE TO PIPE-COOLANT		ENQUIRE
PCH002750	TOP HOSE-WATER OUTLET TO T-PIECE	22.11	25.98
PCH002760	TOP HOSE-T-PIECE TO PRT		ENQUIRE
PCH002770	BOTTOM HOSE-Y-PIECE TO PRT	14.95	17.57
PCH002780	BOTTOM HOSE-Y-PIECE TO COOLANT RAIL	6.13	7.20
PCH002792	HOSE ASSY	37.99	44.64
PCH002810	HOSE-PRT TO UNDERFLOOR PIPE	13.85	16.27
PCH002840	HOSE-HEATER-OUTLET	18.35	21.56
PCH002960	HOSE ASSY	60.77	71.40
PCH002970	HOSE ASSY	29.79	35.00
PCH003320	HOSE ASSY	56.29	66.14
PCH003330	HOSE		ENQUIRE
PCH003340	HOSE	4.79	5.63
PCH10476EVA	HOSE-RADIATOR BOTTOM COOLANT	73.72	86.62
PCH10566EVA	PIPE ASSY-COOLING SYSTEM COOLANT	11.70	13.75
PCH10735EVA	HOSE-RADIATOR BOTTOM COOLANT	70.46	82.79
PCH10735EVA	BOTTOM HOSE MINI SPI	51.90	60.98
PCH111600	HOSE-EXPANSION TANK COOLANT	5.76	6.77
PCH112320	HOSE-RADIATOR TOP COOLANT	22.31	26.21
PCH112320P	HOSE-RADIATOR TOP COOLANT	15.75	18.51
PCH112330	HOSE-RADIATOR BOTTOM COOLANT	14.93	17.54
PCH112340	HOSE-COOLING SYSTEM BLEED	58.17	68.35
PCH113480EVA	HOSE-RADIATOR BOTTOM COOLANT	151.68	178.22
PCH113500EVA	HOSE-RADIATOR TO THERMOSTAT	5.67	6.66
PCH113560EVA	HOSE-RADIATOR	20.37	23.93
PCJ000040	SENSOR-LEVEL LOW COOLANT	16.63	19.54
PEB000080	USE PEB000080SLP		
PEB000080P	USE PEB000080SLPP		
PEB000080SLP	PUMP-WATER	54.21	63.70
PEB000080SLPP	PUMP-WATER	36.89	43.35
PEB000115EVA	PUMP-WATER	48.20	56.64
PEB000115EVA	PUMP-WATER MGB '62-'65	36.59	42.99
PEB000130	PUMP ASSY		ENQUIRE
PEB000132SLP	PUMP-WATER	20.11	23.63
PEB10002SLP	PUMP-WATER	52.24	61.38
PEB10031EVA	USE PEB10031SLP		
PEB10031SLP	PUMP-WATER	51.25	60.22
PEB10031SLPP	WATER PUMP	26.36	30.97
PEB10036EVA	USE PEB10036SLP		
PEB10036SLP	PUMP-WATER	26.26	30.86
PEB10036SLPP	PUMP-WATER	16.17	19.00
PEB10037EVA	USE PEB10037SLP		
PEB10037SLP	PUMP-WATER	30.17	35.45
PEB10041EVA	USE PEB10041SLP		
PEB10041SLP	PUMP-WATER	113.97	133.91
PEB10051	USE PEB102510SLP		
PEB10080EVA	USE PEB10080SLP		

WEB ORDER - YOU SHOP - WE DELIVER. www.rimmerbros.co.uk

Part Number	Description	Price £ Ex VAT	Price £ Inc VAT	Part Number	Description	Price £ Ex VAT	Price £ Inc VAT
PEB10080SLP	PUMP-WATER	57.41	67.46				
PEB10080SLPP	WATER PUMP	35.32	41.50				
PEB10095	USE PEB102420L						
PEB10139	USE PEB10139SLP						
PEB10139SLP	PUMP ASSY-ENGINE COOLANT	64.68	76.00				
PEB10139SLPP	WATER PUMP	40.13	47.15				
PEB10143	PUMP BODY-COOLANT	5.82	6.84				
PEB101710SLP	PUMP-WATER	40.41	47.48				
PEB101780EVA	WATER PUMP	17.02	20.00				
PEB101780SLP	PUMP-WATER	30.88	36.28				
PEB101780SLPP	WATER PUMP	29.70	34.90				
PEB101890EVA	USE PEB101890SLP						
PEB101890SLP	PUMP-WATER	126.74	148.92				
PEB101930EVA	USE PEB101930SLP						
PEB101930SLP	PUMP ASSY-ENGINE COOLANT	56.84	66.79				
PEB101930SLPP	WATER PUMP	36.45	42.83				
PEB102010	USE PEB102420L						
PEB102030EVA	USE PEB102030SLP						
PEB102030SLP	PUMP ASSY-ENGINE COOLANT	62.55	73.50				
PEB102240	PUMP ASSY-ENGINE COOLANT	78.31	92.01				
PEB102240P	WATER PUMP	47.23	55.50				
PEB102300	USE PEB102300SLP						
PEB102300SLP	PUMP ASSY-ENGINE COOLANT	54.00	63.45				
PEB102330	USE PEB102330SLP						
PEB102330SLP	PUMP ASSY-ENGINE COOLANT	55.31	64.99				
PEB102420L	OE*WATER PUMP ASSY. WITH O RINGS	43.83	51.50				
PEB102420LP	WATER PUMP ASSY. WITH O RINGS	24.25	28.49				
PEB102470	PUMP ASSY-ENGINE COOLANT	81.00	95.18				
PEB102470P	WATER PUMP	62.98	74.00				
PEB102470SLP	PUMP ASSY-ENGINE COOLANT	110.53	129.87				
PEB102510	USE PEB102510SLP						
PEB102510SLP	PUMP-WATER	60.71	71.33				
PEB102510SLPP	WATER PUMP	17.66	20.75				
PEE002710EVA	GEAR/IMPPELLOR ASSY-COOLANT PUMP	73.59	86.47				
PEE002710EVA	WATER PUMP	22.17	26.05				
PEF10010	OE*THERMOSTAT SEAL PETROL	1.48	1.74				
PEH000090	HOSE TO PIPE-COOLANT	28.91	33.97				
PEH000360	HOSE-OUTLET TO PIPE COOLANT		ENQUIRE				
PEH000410	HOSE ASSY	7.12	8.37				
PEH000420	HOSE TO PIPE-COOLANT		ENQUIRE				
PEH000560	HOSE	15.08	17.72				
PEH000580	HOSE	17.47	20.53				
PEH100790	HOSE ASSY-HEATER	36.82	43.26				
PEH100820	HOSE TO PIPE-COOLANT	10.89	12.80				
PEH100850	HOSE-HEATER RETURN COOLANT	8.53	10.02				
PEH100870	HOSE-THERMOSTAT TO PIPE COOLANT	7.52	8.84				
PEH100900	HOSE-OUTLET TO PIPE COOLANT	6.62	7.78				
PEH100940	HOSE ASSY-HEATER IN/OUT	43.88	51.56				
PEH101420	HOSE TO PIPE-COOLANT	24.36	28.62				
PEH101720	HOSE-HEATER RETURN COOLANT		ENQUIRE				
PEH101730	HOSE-OUTLET TO COOLER COOLANT	96.98	113.95				
PEH101740	HOSE-BYPASS TO HEATER COOLANT		ENQUIRE				
PEI000110	VALVE-BLEED-COOLING	3.95	4.64				
PEL000170	THERMOSTAT	20.55	24.15				
PEL000240	THERMOSTAT		ENQUIRE				
PEL000322EVA	HOUSING ASSY-THERMOSTAT	5.59	6.57				
PEL10002EVA	THERMOSTAT-ENGINE	4.24	4.98				
PEL10004EVA	THERMOSTAT-ENGINE	18.46	21.69				
PEL10007EVA	THERMOSTAT-ENGINE	10.30	12.10				
PEL100116	OE*THERMOSTAT PETROL	7.26	8.53				
PEL10016P	THERMOSTAT PETROL	4.51	5.30				
PEL10017	OE*THERMOSTAT 2.0 MPI	8.40	9.87				
PEL10017P	THERMOSTAT 2.0 MPI	5.11	6.00				
PEL10018EVA	THERMOSTAT-ENGINE	17.90	21.03				
PEL10019EVA	THERMOSTAT-ENGINE	19.49	22.90				
PEL100300EVA	THERMOSTAT	25.46	29.92				
PEL100350	THERMOSTAT-ENGINE	22.66	26.63				
PEL100570	HOUSING-THERMOSTAT	31.63	37.17				
PEM000020	HOUSING-THERMOSTAT	20.53	24.12				
PEM000020P	HOUSING-THERMOSTAT	11.28	13.25				
PEM10025	HOUSING ASSY-THERMO	41.65	48.94				
PEM10025LP	THERMOST ASSY	24.89	29.25				
PEM10051	HOUSING-THERMOST	14.68	17.25				
PEM100990	THERMOSTAT	15.91	18.69				
PEM100990P	THERMOSTAT	12.77	15.00				
PEM101020	THERMOSTAT	30.93	36.34				
PEM101050	THERMOSTAT-ENGINE	28.47	33.45				
PEM101050K	THERMOSTAT KIT KV6 ENGINES	49.95	58.69				
PEP102230	PIPE ASSY-ENGINE HEATER	19.32	22.70				
PEP102470	PIPE ASSY-COOLANT	52.83	62.08				
PEP102470SS	PIPE ASSY-COOLANT [STAINLESS STEEL]	59.53	69.95				
PEP102650	PIPE ASSY-HEATER		ENQUIRE				
PEP103230	PIPE ASSY-COOLANT	54.19	63.67				
PEP103230SS	PIPE ASSY-COOLANT STAINLESS STEEL	59.95	70.44				
PEP103280	PIPE ASSY-COOLANT	38.02	44.67				
PEP100680L	OE*ELBOW	17.76	20.87				
PET10010L	OE*WATER PUMP SEAL-PETROL	3.53	4.15				
PET10010SLP	GASKET-CYLINDER BLOCK COOLANT PUMP	2.29	2.69				
PET10042	GASKET - THERMOSTAT HOUSING	1.30	1.53				
PEV000010	BOTTOM HOSE Y-PIECE	4.71	5.53				
PEW100070	OE*BOLT-COOLANT PUMP SUPPORT	4.99	5.86				
PF1000040	ADAPTOR-HOSE-COOLANT	2.48	2.91				
PFK000030	TOP HOSE T-PIECE	4.75	5.58				
PGF101320	USE PGF101410						
PGF101410	FAN/COWL & MOTOR ASSY	194.92	229.03				
PGG000270	FAN ASSY-COOLING	144.08	169.29				
PGJ000090	USE PGJ000100						
PGJ000100	MOTOR-COOLING SYSTEM FAN	334.12	392.59				
PGJ000110	MOTOR-COOLING SYSTEM FAN	340.00	399.50				
PHB000230	AIR CLEANER ASSY	90.70	106.57				
PHB102040	AIR CLEANER ASSY	88.49	103.98				
PHB103000	AIR CLEANER ASSY	75.95	89.24				
PHD000380	DUCT-AIR CLEANER/THROTTLE BODY IND	29.13	34.23				
PHD000650	DUCT-COLD AIR INTAKE	13.21	15.52				
PHD103010	DUCT ASSY-AIR INTAKE	31.53	37.05				
PHD103020	DUCT-AIR CLEANER	18.95	22.27				
PHE000100	ELEMENT AIR CLEANER	34.69	40.76				
PHE000100K-N	K&N AIR FILTER MGZT V8	39.11	45.95				
PHE000112	OE*ELEMENT ASSY - AIR CLEANER	17.47	20.53				
PHE000112K-N	K&N A/FILTER TDV6	32.30	37.95				
PHE000120	USE PHE000121						
PHE000120K-N	USE PHE000121K-N						
PHE000120P	USE PHE000121P						
PHE000121	ELEMENT AIR CLEANER	6.97	8.19				
PHE000121K-N	K&N AIR FILTER	25.11	29.50				
PHE000121P	AIR FILTER	4.42	5.19				
PHE001003EVA	ELEMENT AIR CLEANER	3.99	4.69				
PHE001004EVA	ELEMENT AIR CLEANER	5.03	5.91				
PHE001003EVA	ELEMENT AIR CLEANER	5.36	6.30				
PHE10002EVA	ELEMENT AIR CLEANER	5.60	6.58				
PHE10002EVAK-N	K&N AIR FILTER R214	26.34	30.95				
PHE10003EVA	ELEMENT AIR CLEANER	4.80	5.64				
PHE10004EVA	ELEMENT AIR CLEANER	6.87	8.07				
PHE10015EVA	ELEMENT AIR CLEANER	5.14	6.04				
PHE10021EVA	ELEMENT AIR CLEANER	4.53	5.32				
PHE10021EVA	AIR FILTER	3.95	4.64				
PHE10022EVA	ELEMENT AIR CLEANER	6.09	7.16				
PHE10022EVA	ELEMENT AIR CLEANER	4.00	4.70				
PHE100240EVA	ELEMENT AIR CLEANER	6.73	7.91				
PHE100330	USE PHE100331						
PHE100331	ELEMENT AIR CLEANER	7.71	9.06				
PHE100331K-N	USE ESR4103K-N						
PHE100331P	AIR FILTER	4.68	5.50				
PHE100370EVA	ELEMENT AIR CLEANER	7.09	8.33				
PHE100390	ELEMENT AIR CLEANER	15.77	18.53				
PHE100390P	AIR FILTER	12.95	15.22				
PHE100420	USE PHE100421						
PHE100421	ELEMENT AIR CLEANER	9.26	10.88				
PHE100421K-N	K&N AIR FILTER MGF 1.8 & WC(K SERIES)	26.34	30.95				
PHE100421P	ELEMENT AIR CLEANER	6.38	7.50				
PHE100460	USE PHE100461						
PHE100460K-N	USE PHE100461K-N						
PHE100461	ELEMENT AIR CLEANER	13.39	15.73				
PHE100461K-N	K&N AIR FILTER	32.29	37.94				
PHE100461P	ELEMENT AIR CLEANER	6.81	8.00				
PHE100501	ELEMENT AIR CLEANER	30.91	36.32				
PHE100501P	ELEMENT AIR CLEANER	10.08	11.84				
PHE100540	ELEMENT AIR CLEANER	13.64	16.03				
PHE100540P	AIR FILTER	12.45	14.63				
PHE105590	ELEMENT AIR CLEANER	17.48	20.54				
PHV100490	RESONATOR-IND SYS	49.42	58.07				
PMF100520	TURBOCHARGER ASSY	1095.00	1286.63				
PMF100520P	TURBOCHARGER ASSY		ENQUIRE				
PMP308	PANHEAD SCREW 10x1/2" CHROME	0.55	0.65				
PMZ308	USE PX505						
PQL100070	SPINDLE-ANCLLARY						

Part Number	Description	Price £ Ex VAT	Price £ Inc VAT
PQS101300	BELT-POLYVEE-AIR COND ALTERNATOR	30.84	36.24
PQS101300LP	BELT-POLYVEE-ALTRN	9.84	11.56
PQS101590	BELT-POLYVEE ALTERNATOR	18.35	21.56
PQS101590P	BELT-POLYVEE ALTERNATOR	15.49	18.20
PSD000210	FLYWHEEL-ENGINE	153.83	180.75
PSD000580	FLYWHEEL	42.55	50.00
PSD10125	FLYWHEEL ASSY-ENGINE	166.54	195.68
PSD101580	FLYWHEEL ASSY-ENGINE 2L PETROL	34.04	40.00
PSD101690	FLYWHEEL ENGINE	167.49	196.80
PSD102230	FLYWHEEL ENGINE	ENQUIRE	
PSD102340	FLYWHEEL ENGINE	25.53	30.00
PSD103252	FLYWHEEL ASSY-ENGINE	413.60	485.98
PSF10003	GEAR-RING-FLYWHEEL	47.66	56.00
PSF10003P	GEAR-RING-FLYWHEEL	23.19	27.25
PSF10008	USE PSF10008SR		
PSF10008SR	GEAR-RING-FLYWHEEL ENGINE	44.92	52.78
PSK10005	BOLT-FIXING FLYWHEEL CRANKSHAFT	1.78	2.09
PX500	SETSCREW 10UNFX5/8"	0.59	0.69
PYCO00540	CLIP-SPRING BAND	ENQUIRE	
PYCO00550	CLIP-SPRING BAND	2.44	2.87
PYCO00590	CLIP-SPRING BAND	2.31	2.71
PYC10027	CLIP	1.66	1.95
PYC101220	CLIP-HOSE	0.89	1.05
PYC101380	OE*CLIP	ENQUIRE	
PYC101400A	CLIP-HOSE	1.06	1.25
PYC101510	CLIP-HOSE	1.07	1.26
PYC101520	CLIP-HOSE	1.50	1.76
PYC101790	CLIP-HOSE	3.10	3.64
PYC102300	CLIP	1.55	1.82
PYG10007	USE PYG10007L		
PYG10007L	OE*BOLT	0.20	0.24
PYP100500	SCREW-BLEED	3.34	3.92
PYX000100	O RING	0.50	0.59
PZE000011	STRIP-RUBBING	1.11	1.30
PZE000021	STRIP-RUBBING	1.36	1.60
PZL000010	FOAM	1.44	1.69
PZL000020	FOAM	3.40	4.00
QAB000240	GEAR ASSY POWER ASSISTED STEERING SURCHARGE	244.39 100.00	287.16 117.50
QAB000240E	RACK ASSY PAS - EXCHANGE SURCHARGE	125.00 100.00	146.88 117.50
QAB000240EP	RACK ASSY PAS - EXCHANGE SURCHARGE	95.00 60.00	111.63 70.50
QAB000250	GEAR ASSY POWER ASSISTED STEERING SURCHARGE	248.36 250.24	291.82 294.03
QAB000250E	RACK ASSY PAS - EXCHANGE SURCHARGE	113.36 150.00	133.20 176.25
QAB000420	GEAR ASSY POWER ASSISTED STEERING	ENQUIRE	
QAB101761EVA	USE QEY10005EVA		
QAB102300	USE QAB102300E		
QAB102300E	RACK ASSY PAS - EXCHANGE SURCHARGE	119.66 0.01	140.60 0.01
QAB102320	USE QAB102320E		
QAB102320E	RACK ASSY PAS - EXCHANGE SURCHARGE	129.19 150.00	151.80 176.25
QAB102330	GEAR ASSY MANUAL STEERING SURCHARGE	275.86 150.00	324.14 176.25
QAB102330E	RACK ASSY PAS - EXCHANGE SURCHARGE	119.46 150.00	140.37 176.25
QAB102442E	RACK ASSY PAS - EXCHANGE SURCHARGE	315.34 100.00	370.52 117.50
QAB102442EP	STEERING RACK POWER SURCHARGE	184.04 100.00	216.25 117.50
QAB102730E	RACK ASSY PAS - LHD ROVER 200 BRM	106.38	125.00
QBZ10001	KIT-STEERING BELLOWS	15.38	18.07
QBZ10001P	STEERING RACK GAITER KIT	8.72	10.25
QEB003337E	RACK MANUAL STEERING SURCHARGE	95.68 150.00	112.42 176.25
QEB003337EP	STEERING RACK MANUAL (EXC. 1.4 GTA) SURCHARGE	34.99 30.00	41.11 35.25
QEB003349E	RACK ASSY STEERING (RHD)	ENQUIRE	
QEB003386E	GEAR ASSY MANUAL STEERING SURCHARGE	292.32 100.00	343.48 117.50
QEY000040	BELLOWS STEERING GEAR-POWER ASS	16.60	19.51
QEY000040P	STEERING RACK BOOT KIT	8.70	10.22
QEY000050	BELLOWS STEERING GEAR-POWER ASS	17.46	20.52
QEY000050P	STEERING RACK BOOT KIT	8.56	10.06
QEY10002	KIT-BELLOWS	23.40	27.50
QEY10005EVA	KIT-BELLOWS	17.92	21.06
QFV000060	STEERING RACK BOOT KIT	12.15	14.28
QFV000060P	KIT-BELLOWS-POWER ASSISTED STEERING	22.84	26.84
QGX100050	STEERING RACK GAITER-ROVER 75	7.02	8.25
QGX100050P	JOINT-BALL-OUTER TRACK ROD	42.21	49.60
QGX100060	TRACK ROD END-LH	11.06	13.00
QGX100060P	JOINT-BALL-OUTER TRACK ROD	42.21	49.60
QGX100060P	TRACK ROD END-RH	11.06	13.00
QGX100140EVA	JOINT-BALL-OUTER TRACK ROD	35.36	41.55
QGX100140EVA	TRACK ROD END-RH	11.70	13.75
QGX100150EVA	JOINT-BALL-OUTER TRACK ROD	35.36	41.55
QGX100150EVA	TRACK ROD END-LH	11.70	13.75
QJB000733EVA	JOINT-BALL-OUTER TRACK ROD	16.45	19.33
QJB10004EVA	JOINT-BALL-OUTER TRACK ROD	11.04	12.97
QJB10004EVA	TRACK ROD END	5.83	6.85
QJB100120	JOINT-BALL-OUTER TRACK ROD	32.69	38.41
QJB100120P	TRACK ROD END	6.11	7.18
QJB100140	JOINT-BALL-OUTER STEERING GEAR	34.44	40.47
QJB100180	JOINT-BALL-OUTER STEERING GEAR	7.62	8.95
QJB100180P	JOINT-BALL-OUTER STEERING GEAR	64.98	76.35
QJB100180P	JOINT-BALL-OUTER STEERING GEAR	18.72	22.00
QJB100190	JOINT-BALL-OUTER STEERING GEAR	64.98	76.35
QJB100190P	JOINT-BALL-OUTER STEERING GEAR	18.72	22.00
QJB100240	JOINT-BALL-OUTER TRACK ROD	35.79	42.05
QJB100240P	TRACK ROD END	7.74	9.09
QJF000040	LEVER-STEERING SWIVEL HUB	28.83	33.88
QJF000050	LEVER-STEERING SWIVEL HUB	27.68	32.52

Part Number	Description	Price £ Ex VAT	Price £ Inc VAT
QJF100100	LEVER-STEERING-HUB	44.30	52.05
QJF100110	LEVER-STEERING-HUB	44.30	52.05
QMB100910	COLUMN ASSY-STEERING	180.13	211.65
QMB101570	COLUMN ASSY-STEERING	697.23	819.25
QMB102270PMP	COLUMN ASSY-STEERING	744.02	874.22
QMH100090	SEAL-STEERING JOINT	8.55	10.05
QMN100182	SHAFT-STRG-COLLAPSE	165.30	194.23
QMN100192	SHAFT-STRG-COLLAPSE	191.22	224.68
QMN100300	SHAFT-STRG-COLLAPSE	24.81	29.15
QMN100310	SHAFT-STRG-COLLAPSE	24.81	29.15
QNB100420	COVER-STEERING JOINT	ENQUIRE	
QNB100430	COVER-STEERING JOINT	2.94	3.45
QRB100332PMA	COWL-INDICATOR LH	4.30	5.05
QRB100350PMA	COWL-INDICATOR RH	4.30	5.05
QRB105890PMA	COWL-LOWER HALF LH INDICATOR SYST	4.67	5.49
QRB105910PMA	COWL-UPPER HALF LH INDICATOR SYST	4.67	5.49
QRF101080	LOCK ASSY-STRG COL	115.51	135.72
QRF101090	LOCK ASSY-STRG COL	115.80	136.07
QRH10001	BOLT-SHEARLOCK-S/COL	3.18	3.74
QTB001230PMA	WHEEL ASSY-STEERING SOFT FEEL	42.55	50.00
QTB001320PMA	WHEEL ASSY-STEER	71.19	83.65
QTB001340JZM	WHEEL ASSY-STEER	133.24	156.56
QTB001340MBG	WHEEL ASSY-STEERING AIRBAG	242.52	284.96
QTB001340PMA	WHEEL ASSY-STEERING AIRBAG	154.36	181.37
QTB001340VAK	WHEEL ASSY-STEER	133.24	156.56
QTB001340VAJ	WHEEL ASSY-STEERING AIRBAG	133.24	156.56
QTB001340WAK	WHEEL ASSY-STEERING AIRBAG	133.24	156.56
QTB001340WDQ	WHEEL ASSY-STEER	ENQUIRE	
QTB001340WDR	USE QTB102731WDR		
QTB001340WDS	USE QTB102731WDS		
QTB001340WGG	WHEEL ASSY-STEERING AIRBAG	133.24	156.56
QTB001340WNN	USE QTB102731WNN		
QTB001360RCM	WHEEL ASSY-STEER	249.47	293.13
QTB101020LBB	WHEEL ASSY-STEERING	253.86	298.29
QTB101020LNF	WHEEL ASSY-STEERING	255.68	300.42
QTB101020PMA	WHEEL ASSY-STEERING	116.10	136.42
QTB101020RDL	WHEEL ASSY-STEERING	ENQUIRE	
QTB101020RIA	WHEEL ASSY-STEERING (MINI COOPER)	267.89	314.77
QTB101020RIB	WHEEL ASSY-STEERING	ENQUIRE	
QTB101020RIJ	WHEEL ASSY-STEERING	212.61	249.82
QTB101020RQL	WHEEL ASSY-STEERING	264.02	310.22
QTB101020RXL	WHEEL ASSY-STEERING	ENQUIRE	
QTB101020RXT	WHEEL ASSY-STEERING	ENQUIRE	
QTB101020WFJ	WHEEL ASSY-STEERING	246.62	289.78
QTB102731WDR	WHEEL ASSY-STEERING	ENQUIRE	
QTB102731WDS	WHEEL ASSY-STEERING	ENQUIRE	
QTB102731WMM	WHEEL ASSY-STEERING	ENQUIRE	
QTB103000PMA	WHEEL ASSY-STEERING	216.29	254.14
QTB103000RIJ	WHEEL ASSY-STEERING	223.89	263.07
QTB103000WDR	WHEEL ASSY-STEERING	215.27	252.94
QTB103000WDS	WHEEL ASSY-STEERING	205.02	240.90
QTB103000WNN	WHEEL ASSY-STEERING	215.27	252.94
QTB103020RCM	WHEEL ASSY-STEERING	201.15	236.35
QTN100160PMP	HORN ASSY-STRG WHEEL	ENQUIRE	
QTN100170PMP	HORN ASSY-STRG WHEEL	ENQUIRE	
QVT000020	FLUID-POWER ASSISTED STEERING	5.99	7.04
QYG10016	BOLT-NYLON-PATCH	0.87	1.02
QYG10019	BOLT-J	4.44	5.22
R81001	PAIR STRUT ASY HD R800	25.75	30.26
RA610185	FLIRT-POP-STEEL	0.45	0.53
RB7082PILOT	HALOGEN CONV.KIT LHD WIPAC	51.45	60.45
RB7092	REAR FOG LAMP	9.32	10.95
RB7129	HALOGEN CONVERSION KIT RHD WIPAC	36.00	42.30
RB7129PILOT	HALOGEN CONV. KIT RHD WIPAC	48.92	57.48
RB7355SA	INERTIA SEAT BELT KIT EACH.30CM.STALK	37.87	44.50
RB7409	HEADLIGHT UNIT LHD (HALOGEN)	25.96	30.50
RB7458	ELECTRONIC MALLORY ELECTRONIC DISTRIBUTOR	208.51	245.00
RBB071541EVA	DAMPER ASSY FRONT	27.74	32.59
RBB071541EVA GAZ	FRT.S/ABS MINI STD.R/HEIGHT PR	74.89	88.00
RBB071541EVA GAZ	LOW FRT.S/ABS MINI LWR.R/HEIGHT PR	74.89	88.00
RBB071541EVA SPAX	FRT.S/ABS MINI STD.R/HEIGHT PR	75.73	88.98
RBB071541EVA SPAX	LO FRT.S/ABS MINI LWR.R/HEIGHT PR	75.73	88.98
RBB071541EVA	FRONT SHOCK ABSORBER	15.53	18.25
RBG000020	USE RBG000020SLP		
RBG000020SLP	KIT-BALL JOINT	34.17	40.15
RBG000020SLPP	UPPER BALL JOINT	7.62	8.95
RBJ000160	USE RBJ100781 & RBJ100791 - FIT IN PAIRS		
RBJ000170	USE RBJ100791 & RBJ100781 - FIT IN PAIRS		
RBJ000220	ARM ASSY-SUSPENSION	ENQUIRE	
RBJ000230	ARM ASSY-SUSPENSION	ENQUIRE	
RBJ000370	ARM ASSY-LOWER FRONT SUSPENSION CONTROL ARM-RH	119.10	139.94
RBJ000740	RH LOWER FRONT SUSPEN ARM MGT	85.51	104.00
RBJ000740P	RH LOWER FRONT SUSPEN ARM MGT	109.37	128.51
RBJ000740P	RH LOWER FRONT SUSPEN ARM MGT	66.89	78.60
RBJ000750P	LH LOWER FRONT SUSPEN ARM MGT	109.37	128.51
RBJ000750P	LH LOWER FRONT SUSPEN ARM MGT	66.89	78.60
RBJ000761	ARM ASSY-LOWER FRONT SUSPENSION	280.06	329.07
RBJ000771	ARM ASSY-LOWER FRONT SUSPENSION	280.06	329.07
RBJ000840	ARM ASSY-UPPER FRONT SUSPENSION	68.48	80.46
RBJ000850	ARM ASSY-UPPER FRONT SUSPENSION	65.23	76.65
RBJ001085EVA	USE RBJ100781		
RBJ001086EVA	USE RBJ100791		
RBJ001087EVA	ARM ASSY-RADIUS REAR SUSPENSION	105.85	124.37
RBJ001087EVA	TRACK CONTROL ARM LH REAR	31.77	37.33
RBJ001088EVA	ARM ASSY-RADIUS REAR SUSPENSION	109.06	128.15
RBJ001088EVA	TRACK CONTROL ARM RH REAR	31.77	37.33
RBJ10004-5	PAIR UPPER SUSPENSION ARMS	42.55	50.00
RBJ10034	USE RBJ10034SLP		
RBJ10034SLP	ARM ASSY-LOWER FRONT SUSPENSION	80.30	94.35
RBJ10034SLPP	LOWER WISHBONE RH (EXC. 1.4 GTA)	32.34	38.00
RBJ10035	USE RBJ10035SLP		

Part Number	Description	Price £ Ex VAT	Price £ Inc VAT
RBJ10035SLP	ARM ASSY-LOWER FRONT SUSPENSION	80.30	94.35
RBJ10035SLPP	LOWER WISHBONE RH (EXC. 1.4 GTA)	32.34	38.00
RBJ100690	ARM ASSY-SUSPEN- FRONT LOWER-RH	24.95	29.32
RBJ100690-720	PAIR FRONT LOWER SUSP.ARMS	34.04	40.00
RBJ100720	ARM ASSY-SUSPEN- FRONT LOWER-LH	24.95	29.32
RBJ100720-690	USE RBJ100690-720		
RBJ100781	ARM ASSY-LOWER FRONT SUSPENSION	78.64	92.40
RBJ100781P	TRACK CONTROL ARM RH	20.42	23.99
RBJ100791	ARM ASSY-LOWER FRONT SUSPENSION	90.70	106.57
RBJ100791P	TRACK CONTROL ARM LH	20.42	23.99
RBJ101060	USE RBJ000740 & RBJ000750 - FIT AS PAIR		
RBJ101060P	USE RBJ000740P & RBJ000750P		
RBJ101070	USE RBJ000740 & RBJ000750 - FIT AS PAIR		
RBJ101070P	USE RBJ000740P & RBJ000750P		
RBJ101200	ARM-FRONT & REAR SUSPENSION UPPER	79.25	93.12
RBJ101210	ARM-FRONT & REAR SUSPENSION UPPER	79.25	93.12
RBJ102220	USE RBJ102220SLP		
RBJ102220SLP	ARM ASSY-LOWER FRONT SUSPENSION	211.69	248.74
RBJ102220SLPP	ARM ASSY-SUSPENSION RH	67.23	79.00
RBJ102230	ARM ASSY-SUSPENSION	189.39	222.53
RBJ102230P	ARM ASSY-SUSPENSION LH	67.23	79.00
RBJ102510	ARM ASSY-LOWER FRONT SUSPENSION	119.10	139.94
RBJ102510P	CONTROL ARM-LH	88.51	104.00
RBK000090	JOINT-BALL-UPPER FRONT SUSPENSION	25.34	29.77
RBK000100	JOINT-BALL-UPPER FRONT SUSPENSION	25.31	29.74
RBK000168EVA	USE RBK000168EVA		
RBK000168EVA	TRACK ROD END MGB/C-V8	5.53	6.50
RBK000194EVA	JOINT-BALL-OUTER TRACK ROD	9.53	11.20
RBK000194EVA	TRACK ROD END	4.34	5.10
RBK000301EVA	KIT PIN PIVOT LOWER ARM	16.32	19.18
RBK10007EVA	JOINT ASSY-KNUCKLE	23.69	27.84
RBK10007EVA	KNUCKLE JOINT MINI	3.78	4.44
RBK100200EVA	JOINT-BALL-OUTER TRACK ROD	17.56	20.63
RBK100200EVA	BALL JOINT	10.21	12.00
RBK100350	JOINT-BALL-LOWER FRONT SUSPENSION	29.42	34.57
RBK100350P	BALL JOINT	10.42	12.24
RBK100380	JOINT-BALL-LOWER FRONT SUSPENSION	33.47	39.33
RBK100380P	JOINT-BALL-LOWER FRONT SUSPENSION	12.55	14.75
RBK100400	JOINT-BALL-LOWER FRONT SUSPENSION	39.90	46.88
RBK100400P	BALL JOINT-RH(MGF)	8.46	9.94

RBMW1046-RP1016

Part Number	Description	Price £ Ex VAT	Price £ Inc VAT
RBMW1046	COOPER 'S' INNER FRONT PANEL ->06	120.00	141.00
RBMW1047	NEW MINI RH H/LAMP RIM(NO WASH HOLE)	13.40	15.75
RBMW1048	NEW MINI LH H/LAMP RIM(NO WASH HOLE)	13.40	15.75
RBMW1049	NEW MINI RH F.WING ->06	26.81	31.50
RBMW1050	NEW MINI LH F.WING ->06	26.81	31.50
RBMW1051	MINI ONE/COOPER BONNET ->06	185.53	218.00
RBMW1052	NEW MINI RH DOOR MIRROR(HEATED)	85.96	101.00
RBMW1053	NEW MINI LH DOOR MIRROR(HEATED)	85.96	101.00
RBMW1054	NEW MINI RH DR.MIR.(HEAT.AUTOBACK)	113.19	133.00
RBMW1055	NEW MINI LH DR.MIR.(HEAT.AUTOBACK)	113.19	133.00
RBMW1056	"MONSOON" OUTDOOR CAR COVER	93.57	109.94
RBMW1057	ULTRA HALO RING IND.& S/LIGHT(P/R)	57.87	68.00
RBMW1058	USE MLFL1602U		
RBMW1059	USE MLFR1602U		
RBMW1060	BONNET-BMW MINI COOPER'S	222.13	261.00
RBR000020	SHAFT-UPPER SUPPORT ARM	44.97	52.84
RB100101	BRACKET-CLAMP ROLL BAR MOUNTING	7.14	8.39
RBX000770	BUSH-REAR ARM LOWER SUPPORT	10.19	11.97
RBX000770P	FRONT LOWER ARM REAR BUSH	3.92	4.61
RBX000770POLY	BUSH-REAR ARM LOWER SUPPORT POLY		ENQUIRE
RBX10025	BUSH-FRONT ARM LOWER SUPPORT	11.80	13.87
RBX10025P	FRONT LOWER ARM FRONT BUSH	5.32	6.25
RBX10025POLY	BUSH-FRONT ARM LOWER SUPPORT POLY	15.53	18.25
RBX10026	USE RBX000770		
RBX101761	USE RBX101761SLP		
RBX101761SLP	BUSH & HOUSING ASSY-LOWER ARM	57.29	67.32
RBX101761SLPP	BUSH & HOUSING ASSY-LOWER ARM	34.89	41.00
RBX101771	BUSH & HOUSING ASSY.-LOWER ARM		ENQUIRE
RBX101771P	BUSH & HOUSING ASSY-LOWER ARM	34.89	41.00
RBZ10001	CLIP	0.84	0.99
RCL0003ENG	DHB ENG	28.21	28.21
RCL0015ENG	DHB ENG	29.05	29.05
RCL0198ENG	USE RCL0245ENG		
RCL0199ENG	L-DRV HBOOK-ROV 400	9.43	9.43
RCL0216ENG	L-HANDBOOK	9.43	9.43
RCL0245ENG	L-HANDBOOK-ENGLISH	31.43	31.43
RCL0256ENG	L-HANDBOOK	8.85	8.85
RCL0306ENG	L-HANDBOOK-OWNERS	33.00	33.00
RCL0332ENG	L-HANDBOOK-MGF	29.85	29.85
RCL0332ENGP	MGF OWNER'S HANDBOOK	12.25	12.25
RCL0361ENG	L-HANDBOOK-OWNERS		ENQUIRE
RDB000010	WASHER-THRUST	7.48	8.79
REB000670	SPRING-ROAD FRONT COIL	27.67	32.51
REB001220	SPRING-ROAD FRONT COIL	35.03	41.16
RFB000200	HUB FRONT SUSPENSION	70.75	83.13
RFB000210	HUB FRONT SUSPENSION	70.75	83.13
RFCC001005EVA	BEARING ASSY	9.70	11.40
RFCC001005EVA	FRT.WHL.BRG.KIT MGB,C & V8	8.72	10.25
RFG0100070	AXLE-STUB-HUB FRONT SUSPENSION	81.48	95.74
RFG100090	AXLE-STUB-HUB FRONT SUSPENSION	81.41	95.66
RFM0000050	USE RFM0000050SLP		
RFM0000050SLP	KIT-HUB BEARING	54.02	63.47
RFM0000050SLPP	KIT-HUB BEARING	26.81	31.50
RFM0000060	USE RFM0000060SLP		
RFM0000060SLP	KIT-HUB BEARING	43.79	51.45
RFM0000060SLPP	WHEEL BEARING KIT	23.40	27.50
RFM000070	KIT-HUB BEARING	96.23	113.07
RFM000070P	USE RLB000060P		
RFM001287EVA	KIT-HUB BEARING	29.60	34.78
RFM001287EVA	USE ADU9665EVA		
RFM001483EVA	KIT-HUB BEARING	43.50	51.11
RFM001483EVA	WHEEL BEARING KIT	39.95	46.94
RFM001484EVA	KIT-HUB BEARING	71.44	83.94
RFM001511EVA	KIT-HUB BEARING	24.96	29.33
RFM001805EVA	KIT-HUB BEARING	14.30	16.80
RFM001805EVA	WHEEL BEARING KIT MINI REAR	10.85	12.75
RFM001806EVA	KIT-HUB BEARING	19.62	23.05
RFM001806EVA	WHEEL BEARING KIT	13.19	15.50
RFM001807EVA	KIT-HUB BEARING	19.62	23.05
RFM001807EVA	USE RFM001806EVA		
RGB000291	BAR ASSY-ANTI-ROLL REAR SUSPENSION	44.17	51.90
RGB100361	BAR ASSY-ANTI ROLL	42.37	49.78
RGB100540	BAR-TIE-BENT-RR SUSP	84.86	99.71
RGD000463	ARM ASSY-TRAILING REAR SUSPENSION	379.59	446.02
RGD000473	ARM ASSY-TRAILING REAR SUSPENSION	402.49	472.93
RGD000570	LINK ASSY-TRAILING REAR SUSPENSION	71.74	84.29
RGD000571	LINK ASSY-TRAILING REAR SUSPENSION	79.93	93.92
RGD000620	TRAILING REAR SUSPENSION R/H	97.92	115.06
RGD000630	LINK ASSY-TRAILING REAR SUSPENSION	97.92	115.06
RGD000660	LINK ASSY-REAR SUSPENSION ANTI ROLL	15.74	18.49
RGD000660P	STABILISER LINK	13.49	15.85
RGD000670	LINK ASSY-REAR SUSPENSION ANTI ROLL	16.72	19.65
RGD000670P	USE RGD000660P		
RGD000920	LINK ASSY-RH-R/SUSPENSION UPPER	68.15	80.08
RGD000930	LINK ASSY-LH-R/SUSPENSION-UPPER	68.15	80.08
RGD10008	LINK ASSY-RR SUSPN	120.56	141.66
RGD10009	LINK ASSY-RR SUSPN		ENQUIRE
RGD100180	LINK-ANTI-ROLL BAR	12.75	14.98
RGD100180P	REAR SUSPENSION LINK-MGF	5.91	6.94
RGG000242	USE RGG000243		
RGG000243	ARM ASSY-LOWER REAR SUSPENSION	164.31	193.06
RGG000253	ARM ASSY-LOWER REAR SUSPENSION	164.31	193.06
RGG001219EVA	JOINT-ROLLER-RADIUS ARM REAR SUS	39.39	46.28
RGG10202	ARM ASSY-RADIUS-REAR	266.68	313.35
RGG10203	ARM ASSY-RADIUS-REAR	284.60	334.41
RGG102390	USE RBJ001088EVA		
RGG102430	USE RBJ001087EVA		

WEB ORDER - YOU SHOP - WE DELIVER. www.rimmerbros.co.uk

Part Number	Description	Price £ Ex VAT	Price £ Inc VAT
RGG103680	ARM ASSY-SUSPENSION	178.28	209.48
RGG103680ADJ	ARM ASSY-SUSPENSION ADJUSTABLE		ENQUIRE
RGG104040	ARM ASSY-TRAILING REAR SUSPENSION	313.08	367.87
RGG104042	ARM ASSY-TRAILING REAR SUSPENSION	231.95	272.54
RGG104050	ARM ASSY-TRAILING REAR SUSPENSION	294.67	346.24
RGG104051	ARM ASSY-TRAILING REAR SUSPENSION	187.61	220.44
RGG104060	ARM ASSY-TRAILING REAR SUSPENSION		ENQUIRE
RGG104062	ARM ASSY-TRAILING REAR SUSPENSION	270.29	317.59
RGG104070	ARM ASSY-TRAILING REAR SUSPENSION	198.18	232.86
RGG104072	ARM ASSY-TRAILING REAR SUSPENSION	270.29	317.59
RGG104920	ARM ASSY-TRAILING REAR SUSPENSION	235.26	276.43
RGG104930	ARM ASSY-TRAILING REAR SUSPENSION	235.26	276.43
RGU000160	COMPLIANCE BUSH AND BRACKET ASSY		ENQUIRE
RGU000170	COMPLIANCE BUSH AND BRACKET ASSY	60.39	70.96
RGU000240	COMPLIANCE BUSH AND BRACKET ASSY		ENQUIRE
RGU000250	COMPLIANCE BUSH AND BRACKET ASSY	51.08	60.02
RGU100221	BRACKET-ANTI-ROLL BAR MOUNTING REAR		ENQUIRE
RGU100231	BRACKET-ANTI-ROLL BAR MOUNTING REAR	3.44	4.04
RGX000920	BUSH-ROLL BAR MOUNTING	6.87	8.07
RGX000920P	BUSH-ROLL BAR MOUNTING	1.19	1.40
RGX000920POLY	BUSH-ROLL BAR MOUNTING POLY		ENQUIRE
RGX10006	BUSH-ANTI-ROLL BAR	1.47	1.73
RGX10006POLY	BUSH-ANTI-ROLL BAR POLY	7.23	8.50
RGX100440	USE RGX000920		
RGX100470	BUSH-TRANSFER LINK	8.62	10.13
RGX100470P	BUSH-TRANSFER LINK	1.62	1.90
RGX100470POLY	BUSH-TRANSFER LINK POLY		ENQUIRE
RGX100480	BUSH-TIE ROD MTG	22.21	26.10
RGX100480POLY	BUSH-TIE ROD MOUNTING-POLY	13.57	15.94
RGX100980	BUSH-TRAILING ARM REAR SUSPENSION	32.51	38.20
RGX100980P	BUSH-TRAILING ARM REAR SUSPENSION	6.17	7.25
RGZ100050	ROD-TRACK CONTROL	174.38	204.90
RGZ100050P	TRACK CONTROL ARM	103.83	122.00
RH5272	SERVO KIT	103.83	122.00
RH5272RKIT	SERVO VALVE REPAIR KIT	12.77	15.00
RHM001173EVA	KIT-RADIUS ARM REAR SUSPENSION	16.36	19.22
RHM10001	USE RHM10001EVA		
RHM10001EVA	KIT-RADIUS ARM REAR SUSPENSION	54.30	63.80
RHM10001EVA	REAR RADIUS ARM KIT	18.30	21.50
RHT000020	BOLT-REAR SUSPENSION	0.87	1.02
RKB000520	SPRING-ROAD REAR COIL	44.74	52.57
RKB000880	SPRING-ROAD REAR COIL	38.66	45.43
RKB10003EVA	JOINT-BALL-OUTER TRACK ROD	20.16	23.69
RKB10003EVA	LOWER BALL JOINT	5.96	7.00
RKC1624	FUEL PUMP (PUSH-ON CONNECTIONS)	15.35	18.04
RL1262	LUMINATION ELECTRONIC IGNITION KIT	143.25	168.32
RL1377	K&N AIR FILTER (HS4 CARBS) EACH	36.55	42.95
RL1397	K&N AIR FILTER (HS2 CARBS) 1300	33.62	39.50
RLB000050	KIT-HUB BEARING	81.07	95.26
RLB000050P	WHEEL BEARING KIT	54.04	63.50
RLB000060	KIT-HUB BEARING	104.98	123.35
RLB000060P	WHEEL BEARING KIT	89.95	105.69
RLB000070	KIT-HUB BEARING	104.98	123.35
RLB001564EVA	HUB ASSY-REAR	60.26	70.81
RLB001564EVA	WHEEL BEARING KIT	50.17	58.95
RLB001570EVA	BEARING REAR HUB	60.26	70.81
RLB100292	KIT-HUB BEARING	126.79	148.98
RLB100292P	WHEEL BEARING KIT	69.95	82.19
RLH000320	HUB REAR	89.44	105.09
RLH000330	HUB REAR	90.57	106.42
RLH101100	HUB REAR	76.31	89.66
RLH101110	HUB REAR	76.31	89.66
RLJ10001	STUD	3.21	3.77
RLJ10001P	WHEEL STUD MINI	0.89	1.05
RLM000011	SPACER	6.14	7.21
RLM000020	SPACER	3.71	4.36
RLM000021	SPACER	3.04	3.57
RNB000260	DAMPER	93.17	109.47
RNB000260P	FRONT SHOCK ABSORBER	32.77	38.50
RNB000320	DAMPER ASSY FRONT	134.31	157.81
RNB000330	DAMPER ASSY FRONT	134.80	158.39
RNB000340	DAMPER ASSY FRONT	145.52	170.99
RNB000360	DAMPER ASSY FRONT	134.31	157.81
RNB000370	DAMPER ASSY FRONT	134.31	157.81
RNB000380	DAMPER ASSY FRONT	131.62	154.65
RNB000381	DAMPER ASSY FRONT	126.08	148.14
RNB000390	DAMPER ASSY FRONT	131.62	154.65
RNB000391	DAMPER ASSY FRONT		ENQUIRE
RNB000400	DAMPER FRONT	131.62	154.65
RNB000410	DAMPER FRONT	131.62	154.65
RNB000880	DAMPER FRONT	128.17	150.60
RNB000890	DAMPER FRONT	128.13	150.55
RNB000891	DAMPER FRONT	116.93	137.39
RNB001040	DAMPER ASSY FRONT	118.75	139.53
RNB001050	DAMPER ASSY FRONT	118.75	139.53
RNB001060	DAMPER ASSY FRONT		ENQUIRE
RNB001070	DAMPER ASSY FRONT	105.88	124.41
RNB001080	DAMPER ASSY FRONT	244.33	287.09
RNB001090	DAMPER	93.21	109.52
RNB001180	DAMPER	108.36	127.32
RNB001210	DAMPER FRONT	116.77	137.20
RNB072098EVA	DAMPER REAR		ENQUIRE
RNB072098EVA	RHR S/ABSORBER R827	49.95	58.69
RNB072099EVA	DAMPER REAR		ENQUIRE
RNB072099EVA	LHR S/ABSORBER R827	49.95	58.69
RNB072315EVA	DAMPER REAR	16.82	19.76
RNB10097EVA	DAMPER		ENQUIRE
RNB10106EVA	DAMPER ASSY FRONT	63.57	74.69
RNB10107EVA	DAMPER	66.59	78.24
RNB101940EVA	DAMPER ASSY FRONT	71.84	84.41

Part Number	Description	Price £ Ex VAT	Price £ Inc VAT
RNB101950EVA	DAMPER ASSY FRONT	73.62	86.50
RNB102370EVA	DAMPER ASSY FRONT	65.95	77.49
RNB102581EVA	DAMPER ASSY FRONT	71.19	86.00
RNB102591EVA	DAMPER ASSY FRONT	73.19	86.00
RNB102720EVA	DAMPER ASSY FRONT		ENQUIRE
RNB102741EVA	DAMPER ASSY FRONT-RH R620 TURBO	69.95	82.19
RNB103470	DAMPER ASSY FRONT	119.09	128.18
RNB103470P	SHOCK ABSORBER	61.04	71.72
RNB103480	DAMPER ASSY FRONT	115.09	135.23
RNB103480P	USE RNB103470P		
RNB103490	DAMPER ASSY FRONT	110.44	129.77
RNB103490P	USE RNB103470P		
RNB103500	DAMPER ASSY FRONT		ENQUIRE
RNB103500P	USE RNB103470P		
RNB103510	DAMPER ASSY FRONT	103.94	122.13
RNB103510P	USE RNB103470P		
RNB103520	DAMPER ASSY FRONT	109.65	128.84
RNB103520P	USE RNB103470P		
RNB104600	DAMPER ASSY FRONT	122.29	143.69
RNB104610	DAMPER & SPRING ASSY FRONT	93.56	109.93
RNC000021	RETAINER	6.40	7.52
RND072530EVA	SPAX AS SPAX ADJ.SPRG.SEAT FRT. STRUT	208.51	245.00
RND072530EVA	FRONT S/ABSORBER	16.81	19.75
RND072554EVA	STRUT-FRONT	17.02	20.00
RND10032EVA	DAMPER ASSY FRONT	55.35	65.04
RND10032EVA	FRONT SHOCK ABSORBER RH	49.95	58.69
RND10033EVA	DAMPER ASSY FRONT	58.40	68.62
RND10033EVA	FRONT SHOCK ABSORBER LH	49.95	58.69
RND10129EVA	DAMPER ASSY FRONT	58.17	68.35
RND101880EVA	DAMPER ASSY FRONT	70.08	82.34
RND101980EVA	DAMPER ASSY FRONT	60.64	71.25
RND101990EVA	DAMPER ASSY FRONT	57.48	67.54
RND102751EVA	DAMPER ASSY FRONT-LH R620 TURBO	10.99	12.91
RND103100EVA	DAMPER ASSY FRONT		ENQUIRE
RND103110EVA	DAMPER ASSY FRONT	64.38	75.65
RND103440EVA	STRUT ASSY FRONT	67.75	79.61
RND103450EVA	STRUT ASSY FRONT	68.35	80.31
RND103470	DAMPER ASSY FRONT	139.42	163.82
RND103470P	USE RND10033EVA (LH) OR RND10032EVA (RH)		
RND103480	DAMPER ASSY FRONT	112.94	132.70
RND103480P	USE RND10033EVA (LH) OR RND10032EVA (RH)		
RND103490	DAMPER ASSY FRONT	151.74	178.29
RND105220	DAMPER ASSY FRONT		ENQUIRE
RND105321	DAMPER ASSY FRONT	126.67	148.84
RND105331	DAMPER ASSY FRONT	126.58	148.73
RND105340	DAMPER ASSY FRONT	126.67	148.84
RND105350	DAMPER ASSY FRONT	123.70	145.35
RND105360			

Part Number	Description	Price £ Ex VAT	Price £ Inc VAT
RP1017	ESSENTIALS & INTERIOR CARE KIT	24.95	29.32
RP1018	MGF FRONT BRAKE KIT (TF160/TROPHY)	306.81	360.50
RP1018P	MGF FRONT BRAKE KIT (TF160/TROPHY)	99.00	116.33
RP1018UR	MGF BRK KIT (T-GROOVE DISCS & GS PADS)	159.00	186.83
RP1019	MGF FRONT BRK KIT (NOT TF160/TROPHY)	89.00	104.58
RP1019P	MGF FRONT BRK KIT (NOT TF160/TROPHY)	38.63	45.39
RP1019UR	MGF BRK KIT (T-GROOVE DISCS & GS PADS)	139.05	163.38
RP1020SS	MGF S/S ROLL HOOPS KIT	255.00	299.63
RP1020WS	MGF WHITE SILVER ROLL HOOPS KIT	259.00	304.33
RP1021	FRONT FOGLAMP KIT	41.20	48.41
RP1022	CORGI 1/43 DIE CAST ROVER 75 (BRG)	13.40	15.75
RP1022 01	CORGI 1/43 DIE CAST ROVER MG ZT -	13.40	15.75
RP1022 02	DIE CAST 1/43 MGZT TROPHY YELLOW	ENQUIRE	
RP1022 03	DIE CAST 1/43 MGZT SOLAR RED	10.85	12.75
RP1023GAZ	GAZ S/ABSORBERS -FR/REAR-MGF(PR)	115.73	135.98
RP1023KONIFRONT	KONI S/ABSORBERS-FRONT -PAIR	263.83	310.00
RP1023KONIREAR	KONI S/ABSORBERS-REAR PAIR	263.83	310.00
RP1023SPAX	SPAX SHOX-FRT/REAR-MGF(PR)	115.73	135.98
RP1024	SPAX SHOX-FRONT-MGTF-STD/SPORTS	154.89	182.00
RP1025	SPAX SHOX-MGTF-REAR-STD/SPORTS	154.89	182.00
RP1026	K&N INDUCTION KIT MGF 1.8&VVC	74.00	86.95
RP1027	K&N INDUCTION KIT MG TF 1.8	85.06	99.95
RP1028	MGF WORKSHOP MANUAL	43.00	43.00
RP1029	MGF/TF PERFORMANCE PORTFOLIO	14.00	14.00
RP1030	MGF-HAYNES MODERN SPORTS CARS	20.25	20.25
RP1031	POWER BOOST VALVE	89.36	105.00
RP1032	ULTIMATE BUYERS' GUIDE-MGF/TF	11.25	11.25
RP1033	BOOK-'MG X-POWER SV'(KNOWLES)	27.50	27.50
RP1034	GOODRIDGE BRAKE HOSE KIT MGF	48.94	57.50
RP1035	GOODRIDGE BRAKE HOSE KIT MGTF	57.83	67.95
RP1037	PERFORMANCE HT LEAD SET(BLUE)	54.47	64.00
RP1037K	PERFORMANCE LEAD KIT BLUE	54.47	64.00
RP1039	AD PRINT-GREEN MGF(VM1595)	5.91	6.94
RP1040	AD PRINT - RED MGF	5.91	6.94
RP1040FM	FRIDGE MAGNET-MGF	1.96	2.30
RP1041	HAYNES W/MANUAL-MINI('69-01)up to X'	19.99	19.99
RP1042	CLEAR SIDE REPEATER LENS CONVERT KIT	3.36	3.95
RP1043BLACK	HOOD STOWAGE COVER-VINYL-MGF/TF	100.42	117.99
RP1043TAHITBLUE	HOOD STOWAGE COVER-VINYL-MGF/TF	100.42	117.99
RP1044	LIMITED SLIP DIF (QUAIFE)MGF	604.25	709.99
RP1045	COVER-ZONE "MONSOON" "MGF"	103.79	121.95
RP1046	POLYURETHANE BUSH KIT MGF FRONT	31.49	37.00
RP1046TF	POLYBUSH POLYBUSH KIT MGTF FRONT KIT 107	57.83	67.95
RP1047	POLYURETHANE BUSH KIT MGF REAR	83.40	98.00
RP1047TF	POLYBUSH POLYBUSH KIT MGTF REAR KIT 108	165.96	195.00
RP1048	POLYURETHANE BUSH KIT MGF F&R	106.71	125.38
RP1048	POLYBUSH POLYBUSH MGF FULL BUSH KIT - KIT 86169.36	199.00	
RP1048TF	POLYBUSH POLYBUSH KIT MG TF FRONT & REAR 212.77	250.00	
RP1049	MG KEY FOB-BROWN/CREAM	4.08	4.79
RP1050	USE RP1049 OR RP1051 OR RP1052		
RP1051	MG KEY FOB-BLACK/WHITE	4.08	4.79
RP1052	MG KEY FOB-RED/CREAM	4.08	4.79
RP1053	HAYNES W/MANUAL ROVER 45/MG ZS(99-05)19.99	19.99	
RP1054	S/S EXHAUST MANIFOLD MGF	476.59	559.99
RP1055	LINK PIPE MGF	91.90	107.98
RP1056	SPORTS CAT.CONV MGF1	212.76	249.99
RP1057	SPORTS CAT.CONVERTER MGTF 2/02 ON	212.76	249.99
RP1058	CAT.REPLACEMENT PIPE MGF	69.79	82.00
RP1059	SERVICE KIT ZS/45 V6	48.36	56.82
RP1060	SERVICE KIT ZT/75 V6	41.15	48.35
RP1061	GAZ SHOCK/SPRING KIT SET 4 **NLA**	ENQUIRE	
RP1062	K&N INDUCTION KIT MGZR 1.4/R25 1.4i	96.98	113.95
RP1063	K&N INDUCTION KIT(GENERATION 2).	144.64	169.95
RP1064	SERVICE KIT ROVER 75 DIESEL	54.79	64.38
RP1065	SERVICE KIT ROVER 75 DIESEL	41.15	48.35
RP1066	CLUTCH*KIT*(INC.CVR.& PLATE)	165.00	193.88
RP1066P	CLUTCH*KIT*(INC.CVR.& PLATE)	113.19	133.00
RP1067	CLUTCH*KIT*(INC.CVR.& PLT.) 2.0 V6	149.00	175.08
RP1067P	USE F3HK7278		
RP1068	CLUTCH*KIT*(INC.CVR.&PLT.)2.5 V6 & 1.8T149.00	175.08	
RP1069	CLUTCH*KIT*(INC.CVR.&PLT.) DIESEL	149.00	175.08
RP1069P	CLUTCH*KIT*(INC.CVR.&PLT.) DIESEL	132.59	155.79
RP1070	TIMING BELT KIT (INC. BELT & TENSIONER)	49.95	58.69
RP1070P	TIMING BELT KIT (INC. BELT & TENSIONER)	44.38	52.15
RP1071	TIMING BELT KIT (INCBELT & TENSIONER)	53.57	62.94
RP1071P	TIMING BELT KIT (INC. BELT & TENSIONER)	45.26	53.18
RP1072	TIMING BELT KIT (INCBELT, TEN & IDLER)	159.65	187.59
RP1072P	TIMING BELT KIT (INC.BELT, TEN & IDLER)	84.72	99.55
RP1073	TIMING BELT KIT (INC.BELT & TENSIONER)	59.95	70.44
RP1073P	TIMING BELT KIT (INC.BELT & TENSIONER)	49.95	58.69
RP1074	TIMING BELT KIT (INC.BELT & TENSIONER)	57.50	67.56
RP1074P	TIMING BELT KIT (INC.BELT & TENSIONER)	49.95	58.69
RP1075	TIMING BELT KIT (INC.BELT & TENSIONER)	109.00	128.08
RP1075P	TIMING BELT KIT (INC.BELT & TENSIONER)	65.99	77.54
RP1076	**BALL JOINT ONLY** UPPER WISHBONE	12.81	15.05
RP1077	MG TF WORKSHOP MANUAL	39.50	39.50
RP1078	T.BELT KIT AUTO TENS. 26MM BELT	53.57	62.94
RP1078P	T.BELT KIT AUTO TENS. 26MM BELT	41.66	48.95
RP1079	TIMING BELT KIT VVC	89.00	104.58
RP1079P	TIMING BELT KIT VVC	48.93	57.49
RP1080	TIMING BELT KIT 2.0 PETROL	49.95	58.69
RP1080P	TIMING BELT KIT 2.0 PETROL	40.69	47.81
RP1081	USE ZUA000610 BASIC		
RP1081P	USE ZUA000610 BASIC P		
RP1084	USE RP1062		
RP1085	K&N GEN2 INDUCTION KIT MGZR	140.00	164.50
RP1086	K&N INDUCTION KIT R25/MGZR 2.0TD	69.36	81.50
RP1087	USE RP1062		
RP1088	K&N GEN2 INDUCTION KIT MGZS 2.5 V6	144.64	169.95
RP1089	K&N GEN2 INDUCTION KIT R75/MGZT	144.64	169.95

Part Number	Description	Price £ Ex VAT	Price £ Inc VAT
RP1090	USE RP1062		
RP1091	K&N GEN2 INDUCTION KIT R25 1.4i	ENQUIRE	
RP1092ALLOY	MGF DASH TRIM KIT-ALLOY LOOK	80.85	95.00
RP1092CARBON	MGF DASH TRIM KIT-CARBON LOOK	80.85	95.00
RP1092WALNUT	MGF DASH TRIM KIT-WALNUT LOOK	80.85	95.00
RP1093ALLOY	MGF DASH TRIM KIT-ALLOY LOOK	57.87	68.00
RP1093CARBON	MGF DASH TRIM KIT-CARBON LOOK	57.87	68.00
RP1093WALNUT	MGF DASH TRIM KIT-WALNUT LOOK	57.87	68.00
RP1094	GEAR SHIFT SURROUND R200/MG ZR'96>	21.49	25.25
RP1095	COMPETITION PEDAL SETS	25.49	29.95
RP1096BLACK	ANTI-THEFT AERIAL MGF	16.94	19.90
RP1096BLUE	ANTI-THEFT AERIAL MGF	16.94	19.90
RP1096RED	ANTI-THEFT AERIAL MGF	16.94	19.90
RP1096SILVER	ANTI-THEFT AERIAL MGF	16.94	19.90
RP1097BLACK	MG TAX DISC HOLDER-BLACK	16.94	19.90
RP1097SILVER	MG TAX DISC HOLDER-SILVER	16.94	19.90
RP1100	MG LOGO 'TOURING' GEAR KNOB	25.49	29.95
RP1101	GAZ SHOCK/SPRING KIT SET OF 4	468.08	549.99
RP1102	GAZ SHOCK/SPRING KIT SET OF 4	468.08	549.99
RP1103	ELECTRIC FUEL PUMP ONLY	80.31	94.36
RP1104	ELECTRIC FUEL PUMP ONLY	ENQUIRE	
RP1105ALLOY	DASH TRIM KIT-ALLOY LOOK	85.11	100.00
RP1105CARBON	DASH TRIM KIT-CARBON LOOK	85.11	100.00
RP1105WALNUT	DASH TRIM KIT-WALNUT LOOK	85.11	100.00
RP1106	S/S WIRE WHEEL 7.0X16 BOLT-ON(MGF)	289.36	340.00
RP1106K	S/S WIRE WHEEL KIT 4	1079.00	1267.83
RP1107	3 PIECE CARPET SET ALL COLOURS	136.17	160.00
RP1108	3 PIECE CARPET SET ALL COLOURS	136.17	160.00
RP1109	CARPET INSULATION KIT	44.25	51.99
RP1110	3 PIECE CARPET SET ALL COLOURS	142.13	167.00
RP1111	3 PIECE CARPET SET ALL COLOURS	142.13	167.00
RP1112	REAR BRAKE CALIPER WIND BACK CUBE	8.51	10.00
RP1113	DVD-'MG-THE LEGEND'	8.94	10.50
RP1114	POWER BOX ROVER 75 2L.CDTI (130BHP)	297.87	350.00
RP1115	POWER BOX ROVER 75 2L.(116BHP)	297.87	350.00
RP1116	W/MANUAL-AUSTIN/MG METRO	ENQUIRE	
RP1117-14	USE RP117-17		
RP1117-17	KENLOWE FAN KIT(R75/MGZT)	159.15	187.00
RP1118	SERVICE KTT ZR-ZS/25-45 DIESEL 'OE'	22.50	26.44
RP1118P	SERVICE KTT ZR-ZS/25-45 DIESEL	11.28	13.25
RP1119DIAMOND	USE VUB105300		
RP1119WOVEN	FRONT GRILLES-S/S WOVEN PATTERN	59.53	69.95
RP1120CAQ	SIDE AIR DUCTS S/S NIGHTFIRE RED	29.79	35.00
RP1120CMU	SIDE AIR DUCTS S/S S/LAR RED	29.79	35.00
RP1120COF	SIDE AIR DUCTS S/S FLAME RED	29.79	35.00
RP1120EAC	SIDE AIR DUCTS S/S VOLCANO	29.79	35.00
RP1120JRW	SIDE AIR DUCTS S/S TAHI BLUE	ENQUIRE	
RP1120LQW	SIDE AIR DUCTS S/S ANTHRACITE	29.79	35.00
RP1120MNX	SIDE AIR DUCTS S/S SILVER	29.79	35.00
RP1120NNX	SIDE AIR DUCTS S/S WHITE	29.79	35.00
RP1121HFF	SIDE AIR DUCTS WOVEN BRG 3	29.79	35.00
RP1122 DIAMOND	PAIR INTAKE GRILLES ONLY S/S DIAMOND	16.60	19.51
RP1122 WOVEN	PAIR INTAKE GRILLES ONLY S/S WOVEN	16.60	19.51
RP1123	S/S BOOT RACK 7 BAR MGF/TF	103.83	122.00
RP1123 RACK	S/S BOOT RACK 7 BAR MGF/TF	103.83	122.00
RP1124	MESH KIT DIAMOND	65.11	76.50
RP1125	MESH KIT WOVEN	67.06	78.80
RP1126	ENGINE MANUAL AUSTIN/ROVER	ENQUIRE	
RP1127	CLUTCH KIT-CITY ROVER 1400cc	165.96	195.00
RP1128	SPAX FRONT DAMPER (PR)	118.30	139.00
RP1129	SPAX REAR DAMPER (PR)	118.30	139.00
RP1130	SPAX RSX 'COIL OVER' KIT MG ZS	544.68	640.00
RP1131	SKIN SILL-4 DOOR-RH R200/400	18.30	21.50
RP1132	SKIN SILL-4 DOOR-LH R200/400	18.30	21.50
RP1133	LUMENATION KIT MINI (ELEC.DIZZY)	143.17	168.22
RP1134	POLISHED R/COVER-ALLOY-MGB	33.25	39.07
RP1134FK	ALLOY RKR.CVR. FITTING KIT	10.00	11.75
RP1135 C	SS TREAD PLATE MGB LOGO EACH	5.92	6.96
RP1135 GT	SS TREAD PLATE GT LOGO MGB EACH	5.92	6.96
RP1135 MG	S/S TREAD PLATE MG LOGO MGB	5.92	6.96
RP1135 MG PR	SS TREAD PLATE MG LOGO MG PAIR	11.50	13.51
RP1135 MGB	SS TREAD PLATE MGB LOGO	8.46	9.94
RP1135 MGB PR	TREADPLATES(PR) MGB	14.43	16.96
RP1135 V8	SS TREAD PLATE V8 LOGO MGB V8	5.92	6.96
RP1136	HUB SET-W/WHEEL MGB EARED	323.40	380.00
RP1137	HUB SET-W/WHEEL MGB OCTAG.	323.40	380.00
RP1138	POLY BUSH KIT(CAR SET)MGB(CB)	107.23	126.00
RP1139	POLY BUSH KIT(CAR SET)MGB(RB)	108.08	126.99
RP1140	K&N FILTER ASSY MGB	84.21	98.95
RP1141	HAYNES W/MANUAL SPRITE+MIDGET	26.00	26.00
RP1142	HAYNES MANUAL MGB	20.25	20.25
RP1143	HAYNES MANUAL MINI '59-'69	26.00	26.00
RP1144	BRAKE HOSE SET S/S MGB-V8	34.89	41.00
RP1145	HUB SET-W/WHEEL MGB EARED	323.40	380.00
RP1146	HUB SET-W/WHEEL MGB OCTAGONAL	323.40	380.00
RP1147	"MONSOON" OUTDOOR CAR COVER	88.09	103.51
RP1149 BLACK	LEATHER SEAT 'CLASSIC' COMPLETE SURCHARGE	638.30	750.00
RP1150 BLACK	DOOR POCKETS *PAIR*	42.55	50.00
RP1151 BLACK	DOOR POD LEATHER	91.90	107.98
RP1152 BLACK	GEAR LEVER GAITER-LEATHER-AS ORIG	22.98	27.00
RP1153 BLACK	H/BRAKE GAITER & GRIP ASSY - LEATHER	59.56	69.98
RP1154 BLACK	CTR.CONS.LID UPPER+LOWER LEATHER SURCHARGE	160.00	188.00
RP1155 BLACK	'T' BAR LEATHER COVERED SURCHARGE	157.45	185.00
RP1156	OCTAGON LOCK RELEASE COVERS *PAIR*	18.51	21.75
RP1157	SPAX DAMPERS-CAR (SET 4)	213.62	251.00
RP1158	ROVER KEY FOB(VIKING SHIP LOGO)	4.08	4.79
RP1159	'MG' KEY FOB(RED/CHROME)	7.23	8.50
RP1160A	HEATER KNOB POL.ALUMIN	41.28	48.50

Part Number	Description	Price £ Ex VAT	Price £ Inc VAT
RP1160S	HEATER KNOB ANO.SILVER	41.28	48.50
RP1161A	HEATER KNOB SET POL.ALUMIN	41.28	48.50
RP1161S	HEATER KNOB SET ANO.SILVER	41.28	48.50
RP1162A	BEZEL KIT HEATER CONTROL POLISHED ALLOY	ENQUIRE	
RP1162C	BEZEL KIT HEATER CONTROL CHROME	16.59	19.49
RP1162S	BEZEL KIT HEATER CONTROL SILVER	16.59	19.49
RP1163	EXH FIT KIT TO VIN YD522572	19.95	23.44
RP1164	EXH FIT KIT FROM VIN YD522573	22.50	26.44
RP1165	HYDRAGAS PUMP	ENQUIRE	
RP1166	USE 2A4325KP		
RP1167	STD SHOX KIT MGF TO 2D600100	299.00	351.33
RP1167P	STD SHOX KIT MGF TO 2D600100	118.45	139.18
RP1168	STD SHOX KIT MGTF TO VIN 5D639630	410.97	482.89
RP1169	STD SHOX KIT MGTF VIN 5D639631 ON	410.97	482.89
RP1170	STD SHOX KIT SPORTS SUSPENSION	410.97	482.89
RP1171GAZ	UPR SHOX KIT MGF TO VIN 2D600100	185.00	217.38
RP1171KONI	UPR SHOX KIT MGF TO VIN 2D600100	489.25	574.87
RP1171SPAX	UPR SHOX KIT MGF TO VIN 2D600100	215.27	252.94
RP1172SPAX	UPR SHOX KIT MGTF VIN 2D600101 ON	406.85	478.05
RP1173	UPRATED SPRING KIT EIBACH MGTF	161.70	190.00
RP1174	UPR SHOX & SPRING KIT SPAX/EIBACH	421.27	494.99
RP1175	BILSTEIN COMFORT HANDLING PACK	570.21	670.00
RP1176	WHEEL NUT SET 4 LOCKING 12 STD.	147.50	173.31
RP1177LHD	SERVO SUPPORT MOUNTING LHD	23.83	28.00
RP1177RHD	SERVO SUPPORT MOUNTING RHD	23.83	28.00
RP1178	HANDBRAKE GRIP-ALLOY SMOOTH	ENQUIRE	
RP1179B	LEATHER HANDBRAKE GRIP-ALLOY BLACK	31.06	36.50
RP1179BLACK	RICHBROOK H/BRAKE GRIP-ALLOY BLACK	29.75	34.96
RP1179BLUE	HANDBRAKE GRIP-ALLOY BLUE	ENQUIRE	
RP1179RED	HANDBRAKE GRIP-ALLOY RED	ENQUIRE	
RP1179SILVER	RICHBROOK H/BRAKE GRIP-ALLOY SILVER	29.75	34.96
RP1179TITANIUM	RICHBROOK H/BRK GRIP-ALLOY TIT		

RPD102170P-RYH105610

Part Number	Description	Price £ Ex VAT	Price £ Inc VAT
RPD102170P	USE RPD102150P		
RPD102250	DAMPER ASSY REAR	121.17	142.37
RPD102250P	SHOCK ABSORBER	63.28	74.35
RPD102580	DAMPER ASSY REAR	109.12	128.22
RPD102670	DAMPER REAR	119.97	140.96
RPD102680	DAMPER ASSY REAR	111.17	130.62
RPD102740	DAMPER ASSY REAR	124.79	146.63
RPD102970	DAMPER ASSY REAR	93.27	109.59
RPD108411	DAMPER REAR	126.58	148.73
RPD972076EVA	DAMPER ASSY-FRONT-RH	41.87	49.20
RPD972323EVA	DAMPER REAR	7.94	9.33
RPJ000010	HYDRAGAS UNIT-REAR	ENQUIRE	
RPJ000020	HYDRAGAS UNIT-REAR	ENQUIRE	
RPJ100020	HYDRAGAS UNIT-REAR	ENQUIRE	
RPL100080	SPACER	ENQUIRE	
RPM100090	KIT-MOUNTING	8.88	10.43
RPV000031	WASHER-UP MOUNTING SPRING & DAMPER	1.09	1.28
RR11113	LUMINATION ELECTRONIC IGNITION KIT	143.17	168.22
RRB10001	KIT-LOCK NUT-R/WHEEL	11.75	13.81
RRB100100	LOCKING WHEEL NUT SET-MGF	70.77	83.15
RRB100140	KIT-LOCK NUT-R/WHEEL	70.77	83.15
RRB100330	WHEEL NUTS-CAR SET INC.NUTS	109.57	128.74
RRB100460	SET 4 ALLOY WHEEL CENTRES & TOOL	25.53	30.00
RRB100530MNH	WHEEL CENTRES/BOLTS/LOCKING BOLTS	ENQUIRE	
RRC001500MNH	WHEEL-ALLOY ROAD	255.91	300.69
RRC001630MNH	WHEEL-ROAD-ALLOY	235.88	277.16
RRC001630MNHK	WHEEL SET 4	875.00	1028.13
RRC001720EYP	WHEEL ROAD STEEL	ENQUIRE	
RRC002040LEH	WHEEL-ALLOY ROAD	ENQUIRE	
RRC002630MBM	WHEEL-ALLOY ROAD	275.04	323.17
RRC002630MBMK	WHEEL SET 4	1025.00	1204.38
RRC002630MNH	WHEEL-ALLOY ROAD	275.04	323.17
RRC002630MNHK	WHEEL SET 4	1025.00	1204.38
RRC002630PMA	WHEEL-ALLOY ROAD	152.24	178.88
RRC002630PMAK	WHEEL SET 4	595.00	699.13
RRC005330MNH	WHEEL-ALLOY ROAD	51.06	60.00
RRC005570MNH	WHEEL-ALLOY ROAD	ENQUIRE	
RRC005710MNH	WHEEL-ROAD-ALLOY(6J X 15)	210.92	247.83
RRC005710MNHK	WHEEL SET 4	799.00	938.83
RRC108060MNH	WHEEL-ROAD-ALLOY	212.52	249.71
RRC108060MNHK	WHEEL SET 4	799.00	938.83
RRC109640MNH	WHEEL-ALLOY ROAD	ENQUIRE	
RRC110261MNH	WHEEL-ALLOY ROAD	275.06	323.20
RRC110261MNHK	WHEEL SET 4	1025.00	1204.38
RRC110460LEH	WHEEL-ALLOY ROAD	250.04	293.80
RRC110460LEHK	WHEEL SET 4	925.00	1086.88
RRC110460MNH	WHEEL-ALLOY ROAD	ENQUIRE	
RRC110460MNHK	WHEEL SET 4	ENQUIRE	
RRC110471MNH	WHEEL-ALLOY ROAD	168.78	198.32
RRC110471MNHK	ALLOY WHEEL SET 4	650.00	763.75
RRC112832MNH	WHEEL-ALLOY ROAD	249.72	293.42
RRC112832MNHK	WHEEL SET 4	925.00	1086.88
RRC112882MNH	WHEEL-ALLOY ROAD	234.62	275.68
RRC112882MNHK	WHEEL SET 4	875.00	1028.13
RRC113740MNH	WHEEL-ALLOY ROAD	275.04	323.17
RRC113740MNHK	WHEEL SET 4	1025.00	1204.38
RRC113750PMN	WHEEL-STEEL ROAD	21.27	24.99
RRC114710MNH	WHEEL-ALLOY ROAD	224.65	263.96
RRC116520PMN	WHEEL-STEEL ROAD	21.27	24.99
RRD10009	NUT-WHEEL	8.99	10.56
RRD100500	NUT-ALLOY-ROAD WHEEL	9.44	11.09
RRF100040	TYRE VALVE CAP-MINI COOPER	13.95	16.39
RRF100060	(SET-4) VALVE-WHEEL-MG	17.11	20.10
RRF100060P	MG LOGO TYRE VALVE CAPS(SET4)	8.47	9.95
RRG100060P AT	MG LOGO VALVE CAPS *ANTI THEFT*(SET 4)	11.02	12.95
RRG104060	USE RGG104060		
RS11114	HEAD LAMP BOWL & I/RIM.	17.00	19.98
RS1733	5 3/4" HEADLAMP MESH CHROME *PAIR*	11.28	13.25
RTC002111EVA	USE GSC111		
RTC0365EVA	USE GSC109		
RTC1115A	BLEED SCREW METRIC	1.87	2.20
RTC202A	WIPER CABLE (cut to fit)	5.83	6.85
RTC2063	WINDSCREEN BONDING KIT	33.76	39.67
RTC3186P	OIL FILTER EARLY	3.53	4.15
RTC3346	OE*UNIVERSAL JOINT	33.10	38.89
RTC3472P	CONDENSER	1.04	1.22
RTC3526EVA	CONDENSOR	3.18	3.74
RTC3526EVA P	USE GSC113		
RTC3561	USE GFU103		
RTC3633	USE GLB239		
RTC364EVA	SET-DISTRIBUTOR CONTACT	2.04	2.40
RTC364EVA P	CONTACT BREAKER POINTS	1.53	1.80
RTC3990EVA	ROTOR HEAD ASSY.	3.09	3.63
RTC3990EVA P	USE GRA2143		
RTC9011	PARTS CATALOGUE-ROVER 2200(P6)	23.50	23.50
RTC9022B	PARTS CATALOGUE-R 3500/3500S(P6)	36.00	36.00
RUB000150	FLANGE ASSY-DRIVE	97.96	115.10
RUB000150P	FLANGE ASSY-DRIVE	65.00	76.38
RUD100070	BEARING-HUB FRONT AXLE	56.06	65.87
RUD100070P	WHEEL BEARING KIT	ENQUIRE	
RUD100120	BEARING	48.80	57.34
RUD100150	KIT-HUB BEARING	73.31	86.14
RUD100150P	WHEEL BEARING KIT	53.57	62.94
RX1023	HAMMERITE UNDERBODY SEAL (500ML)	3.96	4.65
RX1024	HAMMERITE UNDERBODY SEAL (1 LITRE)	6.77	7.95
RX1025	WAXOYL AEROSOL 200ml	4.04	4.75
RX1026	WAXOYL AEROSOL CLEAR 400ML	8.25	9.69

WEB ORDER - YOU SHOP - WE DELIVER. www.rimmerbros.co.uk

Part Number	Description	Price £ Ex VAT	Price £ Inc VAT
RX1027	WAXOYL 5LTR - CLEAR	33.19	39.00
RX1028	FINNEGAN'S WAXOYL (2.5 litre) CARTRIDGE	22.09	25.96
USE RX1027			
RX1030	WAXOYL HIGH PRESSURE SPRAYER	22.09	25.96
RX1031	USE RX1032		
RX1032	WAXOYL STARTER KIT	47.66	56.00
RX1033	WAXOYL JUMBO TRIGGER SPRAY GUN	14.89	17.50
RX1035	WAXOYL AEROSOL 400mlBLACK	8.25	9.69
RX1257	HOOD SEAM SEALER 60cc	5.11	6.00
RX1261	CLEAR LAQUER AEROSOL 400ml	2.54	2.98
RX1262	WHEEL WAX / RIM WAX 256GR	13.19	15.50
RX1265	AEROSOL - SILVER - 450ML	7.23	8.50
RX1266	AEROSOL - MATT BLACK - 500ML	4.21	4.95
RX1299	STICK ON UNION JACK BADGE ENAMEL*PAIR*	11.70	13.75
RX1312	AUTOGLYM SILICONE RESIN POLISH (325ml)	7.61	8.94
RX1313	AUTOGLYM BODYWORK SHAMPOO (500ml)	5.10	5.99
RX1314	AUTOGLYM CAR INTERIOR SHAMPOO	4.25	4.99
RX1315	AUTOGLYM GLASS POLISH (325ml)	4.25	4.99
RX1316	AUTOGLYM PAINT RENOVATOR(325ml)	4.25	4.99
RX1317	AUTOGLYM EXTRA GLOSS PROTECTION	6.80	7.99
RX1318	AUTOGLYM BUMPER CARE (325ml)	4.68	5.50
RX1319	AUTOGLYM VINYL & RUBBER CARE (500ml)	5.75	6.76
RX1320	AUTOGLYM LEATHER CARE CREAM (500ml)	8.50	9.99
RX1321	SUPERGLYM CHROME POLISH(55ml)	4.25	4.99
RX1322	AUTOGLYM CLEAN WHEELS (500ml)	5.10	5.99
RX1323	AUTOGLYM PERFECT POLISHING CLOTH	5.53	6.50
RX1324	AUTOGLYM AQUA-DRY (Synthetic Chamois)	7.23	8.50
RX1325	AUTOGLYM ENGINE CLEANER(1 litre)	6.35	7.46
RX1326	BRAKE FLUID (SILICONE) 1 litre	25.46	29.92
RX1327	BRAKE FLUID (SILICONE) 0.5 litre	14.65	17.21
RX1329	'AA'MEMBERSHIP & RELAY PACK	74.89	88.00
RX1330	BOOT RACK (ALUMINIUM/WOOD SLATS)	65.40	76.85
RX1330 RACK	BOOT RACK (ALUMINIUM/WOOD SLATS)	65.40	76.85
RX1330ALUMINIUM	BOOT RACK (ALUMINIUM)	50.65	59.51
RX1330ALUMINIUM RACK	BOOT RACK (ALUMINIUM)	50.65	59.51
RX1337	RIMMER BROS £5 GIFT VOUCHER	5.00	5.00
RX1338	RIMMER BROS £10 GIFT VOUCHER	10.00	10.00
RX1339	RIMMER BROS £20 GIFT VOUCHER	20.00	20.00
RX1341	RIMMER BROS £50 GIFT VOUCHER	50.00	50.00
RX1344	'WARNING' TRIANGLE	5.06	5.95
RX1345	CARLUBE COPPER GREASE 70G	2.51	2.95
RX1346	K&N AIR FILTER CLEANING FLUID (1 LITRE)	7.53	8.85
RX1347	K&N AIR FILTER ELEMENT OIL (57c)	3.62	4.25
RX1348	K&N AIR FILTER ELEMENT OIL (250ml)	4.25	4.99
RX1349	K&N AIR FILTER ELEMENT OIL (400ml)	5.97	6.94
RX1353	TRIM ADHESIVE(1 LTR)	12.77	15.00
RX1353AEROSOL	TRIM ADHESIVE SPRAY(500ml)	11.70	13.75
RX1356	'DISCONNECT' BATTERY CUT-OUT	9.79	11.50
RX1356FUSE	'DISCONNECT' 16a FUSE (Pack of 5)	2.21	2.60
RX1356KNOB	SPARE KNOB FOR 'DISCONNECT'	2.81	3.30
RX1358	CAM LUBE 250ML.	5.96	7.00
RX1364	TOOL KIT BAG *HARDURA**	14.35	16.86
RX1367	AUTOGLYM INTENSIVE TAR REMOVER (325ml)	4.25	4.99
RX1368	AUTOGLYM INSTANT TYRE DRESSING	5.10	5.99
RX1370	FRONT FOG LAMP PAIR RING	20.64	24.25
RX1373	HOOD DRESSING-WATERPROOF-CLEAR	6.17	7.25
RX1381 HELLA	USE RX1381 MARCO		
RX1381 MARCO	AIR HORNS(P/R)-MARCO	21.91	25.74
RX1382	EXHAUST INSULATION WRAP 2"x 50" ROLL	46.35	54.46
RX1383	SNAP STRAP KIT 4 X 18" & 8 X 9"	22.98	27.00
RX1395	CASTROL OIL JUG (1/2 pint)	8.08	9.49
RX1396	CASTROL OIL JUG (1 pint)	8.94	10.50
RX1397	CASTROL OIL JUG (2 pints)	10.17	11.95
RX1399	FIRST AID KIT DRAPER	11.02	12.95
RX1405	MWS WHEEL CLEANING KIT	21.70	25.50
RX1406	LATEX GLOVES-DISPOSABLE(100 pack)	3.56	4.18
RX1408L	USE CONS5220		
RX1408M	LIGHTWEIGHT DISPOSABLE OVERALL (med)	ENQUIRE	
RX1408XL	USE CONS5221		
RX1410 CTEK	CTEK800 BATTERY CONDITIONER	38.25	44.94
RX1414MG	SEAT BELT PAD(PAIR MG LOGO)	17.45	20.50
RX1415	CELLULOSE SPONGE	1.66	1.95
RX1416	USE RX1324		
RX1424	INSPECTION LAMP-FITS IN CIGAR LIGHTER	9.79	11.50
RX1432A	CARPLAN FIRECOTE PAINT AEROSOL BLACK	5.92	6.96
USE RX1432A			
RX1432B	CARPLAN ENGINE LAQUER MATT BLACK	6.95	8.17
RX1433	AUTOGLYM FABRIC HOOD KIT	17.01	19.99
RX1443	AUTOGLYM ALLOY WHEEL SEAL 450ml	4.25	4.99
RX1461	USE RX1461-473		
RX1461-473	RAD RELIEF ADDITIVE(CONCENTRATED)	11.48	13.49
RX1462BLACK	SPARK PLUG SLEEVE 2 PACK	19.79	23.25
RX1462BLUE	SPARK PLUG SLEEVE 2 PACK	19.79	23.25
RX1462RED	SPARK PLUG SLEEVE 2 PACK	19.79	23.25
RX1462SILVER	SPARK PLUG SLEEVE 2 PACK	19.79	23.25
RX1463BLACK	SPARK PLUG SLEEVE 8 PACK	73.50	86.36
RX1463BLUE	SPARK PLUG SLEEVE 8 PACK	73.50	86.36
RX1463RED	SPARK PLUG SLEEVE 8 PACK	73.50	86.36
RX1463SILVER	SPARK PLUG SLEEVE 8 PACK	73.50	86.36
RX1464BLACK	HT LEAD SLEEVE 2 CYL.KIT	16.72	19.65
RX1464BLUE	HT LEAD SLEEVE 2 CYL.KIT	16.72	19.65
RX1464RED	HT LEAD SLEEVE 2 CYL.KIT	16.72	19.65
RX1464SILVER	HT LEAD SLEEVE 2 CYL.KIT	16.72	19.65
RX1465BLACK	HT LEAD SLEEVE 8 CYL.KIT	66.38	78.00
RX1465BLUE	HT LEAD SLEEVE 8 CYL.KIT	65.07	76.46
RX1465RED	HT LEAD SLEEVE 8 CYL.KIT	65.07	76.46
RX1465SILVER	HT LEAD SLEEVE 8 CYL.KIT	65.07	76.46
RX1466BLACK	HT LEAD & PLUG SLEEVE KIT 2 CYL.KIT	34.48	40.51
RX1466BLUE	HT LEAD & PLUG SLEEVE KIT 2 CYL.KIT	34.48	40.51
RX1466RED	HT LEAD & PLUG SLEEVE KIT 2 CYL.KIT	34.48	40.51

Part Number	Description	Price £ Ex VAT	Price £ Inc VAT
RX1466SILVER	HT LEAD & PLUG SLEEVE KIT 2 CYL.KIT	34.48	40.51
RX1467BLACK	HT LEAD & PLUG SLEEVE KIT 8 CYL.KIT	133.16	156.46
RX1467BLUE	HT LEAD & PLUG SLEEVE KIT 8 CYL.KIT	133.16	156.46
RX1467RED	HT LEAD & PLUG SLEEVE KIT 8 CYL.KIT	133.16	156.46
RX1467SILVER	HT LEAD & PLUG SLEEVE KIT 8 CYL.KIT	133.16	156.46
RX1468BLACK	HI-TEMP SHRINK TUBES (18X38) 25PK.	18.25	21.44
RX1468BLUE	HI-TEMP SHRINK TUBES (18X38) 25PK.	18.25	21.44
RX1468GREY	HI-TEMP SHRINK TUBES (18X38) 25PK.	18.25	21.44
RX1468RED	HI-TEMP SHRINK TUBES (18X38) 25PK.	18.25	21.44
RX1469BLACK	HI-TEMP SHRINK TUBES (12X38) 25PK.	18.25	21.44
RX1469BLUE	HI-TEMP SHRINK TUBES (12X38) 25PK.	18.25	21.44
RX1469GREY	HI-TEMP SHRINK TUBES (12X38) 25PK.	18.25	21.44
RX1469RED	HI-TEMP SHRINK TUBES (12X38) 25PK.	18.25	21.44
RX1470	UNIVERSAL HEAT SHIELD 7" X 24"	37.45	44.00
RX1471 -50	THERMAL SLEEVE-FIXED TUBE 0.5" X 3'	14.74	17.32
RX1471 -75	THERMAL SLEEVE-FIXED TUBE 0.75" X 3'	17.01	19.99
RX1471 1-0	THERMAL SLEEVE-FIXED TUBE 1.0" X 3'	19.88	23.36
RX1471 1-25	THERMAL SLEEVE-FIXED TUBE 1.25" X 3'	21.79	25.60
RX1471 1-5	THERMAL SLEEVE-FIXED TUBE 1.5" X 3'	24.90	29.26
RX1472	THERMAL SLEEVE-VELCRO 1" X 3'	39.41	46.31
RX1473A	INSULATION MATERIAL (2" X 21")	39.41	46.31
RX1473B	INSULATION MATERIAL (4" X 21")	91.59	93.42
RX1473C	INSULATION MATERIAL (4" X 42")	158.04	185.70
RX1474A	COOL TAPE (1 3/8" X 15')	19.68	23.12
RX1474B	COOL TAPE (1 3/8" X 30')	37.84	44.46
RX1474C	COOL TAPE (2" X 60')	82.38	96.80
RX1478	COLLECTING A-HEALEY, MG & TRIUMPH	14.00	14.00
RX1500	SEAT BELT HARNESS, RED, 4 POINT (EACH)	77.49	91.05
RX1501	SEAT BELT CROTCH HARNESS,RED (EACH)	18.72	22.00
RX1502BLACK	SHOULDER PADS "SECURON" (PAIR)	ENQUIRE	
RX1502RED	SHOULDER PADS "SECURON" (PAIR)	15.96	18.75
RX1503	HARNESS EYE BOLT (PAIR)	8.30	9.75
RX1505	HARNESS BOLT & SPACER SET (PAIR)	5.32	6.25
RX1508	HOLT'S RADWELD 250ml	2.54	2.98
RX1510	CONNOISSEUR CAR CARE KIT AUTOGLYM	69.53	81.70
RX1511	BRADEX EASY START A/SOL 280ml	2.98	3.50
RX1513	TRAILER/REAR LIGHTING BOARD (4 FT)	15.75	18.51
RX1514	OIL FILTER STRAP WRENCH (1/2" DRIVE)	5.53	6.50
RX1524BLACK	'RENOVO'SOFT TOP REVIVER-1ltr.	27.65	32.49
RX1524BLUE	'RENOVO'SOFT TOP REVIVER-1ltr.	27.65	32.49

SPB000370P-UQB000221

Part Number	Description	Price £ Ex VAT	Price £ Inc VAT
SPB000370P	BRAKE CABLE	35.20	41.36
SPB000520	CABLE ASSY HANDBRAKE	105.65	124.14
SPB000530	CABLE ASSY HANDBRAKE	100.56	118.16
SPB000560	CABLE ASSY HANDBRAKE	40.57	47.67
SPB000560P	BRAKE CABLE	18.68	21.95
SPB000570	CABLE ASSY HANDBRAKE	34.22	40.21
SPB000570P	BRAKE CABLE	18.68	21.95
SPB000580	CABLE ASSY HANDBRAKE	48.13	56.55
SPB000580P	BRAKE CABLE	32.88	38.63
SPB000590	CABLE ASSY HANDBRAKE	48.13	56.55
SPB000590P	BRAKE CABLE	32.88	38.63
SPB000600	CABLE ASSY HANDBRAKE	ENQUIRE	
SPB000600P	CABLE ASSY HANDBRAKE-RH	42.51	49.95
SPB000610	CABLE ASSY HANDBRAKE	59.09	69.43
SPB000610P	CABLE ASSY HANDBRAKE-LH	42.51	49.95
SPB002022EVA	CABLE ASSY HANDBRAKE	10.11	11.88
SPB002631EVA	CABLE-HANDBRAKE	12.55	14.75
SPB10010EVA	CABLE-HANDBRAKE-RH	49.58	58.26
SPB10010EVA	BRAKE CABLE	20.64	24.25
SPB10011EVA	CABLE ASSY HANDBRAKE	46.90	55.11
SPB10011EVA	BRAKE CABLE	27.87	32.75
SPB10015EVA	CABLE-HANDBRAKE-LH	28.73	33.76
SPB10015EVA	BRAKE CABLE	20.64	24.25
SPB10016EVA	CABLE-HANDBRAKE-LH	53.39	62.73
SPB10016EVA	BRAKE CABLE	26.50	31.14
SPB10033EVA	CABLE-HANDBRAKE	20.78	24.42
SPB100431EVA	CABLE-HANDBRAKE-RH	33.83	39.75
SPB100441EVA	CABLE-HANDBRAKE-LH	33.83	39.75
SPB100700	CABLE ASSY HANDBRAKE	66.84	78.54
SPB101410	CABLE ASSY HANDBRAKE	12.90	15.16
SPB101550	CABLE ASSY HANDBRAKE	17.02	20.00
SPC100010	NUT-ADJUST H/BRAKE	1.82	2.14
SPCK12	USE CK12		
SPCK5	USE CK5		
SPCK6	USE CK6		
SPCK7	USE CK7		
SPK60CK	USE RP1138		
SPK64CK	USE RP1139		
SQB000180	HOSE ASSY BRAKE VACUUM	22.80	26.79
SQB000190	HOSE ASSY BRAKE VACUUM	9.85	11.57
SQB101961	HOSE ASSY BRAKE VACUUM	48.19	56.62
SQB101971	HOSE ASSY BRAKE VACUUM	8.89	10.45
SRB100550	MODULATOR-ABS	200.00	235.00
SRB101590	MODULATOR-ABS	495.00	581.63
SRD100180	ECU-ABS	100.00	117.50
SS110251	CAPSCREW	1.28	1.50
SSB100790	SENSOR ASSY ANTILOCK BRAKES	65.32	76.75
SSB100881	SENSOR ASSY ANTILOCK BRAKES	65.32	76.75
SSB100891	SENSOR ASSY ANTILOCK BRAKES	65.32	76.75
SSE100430	ADAPTOR-SENSOR ANTILOCK BRAKES	12.82	15.06
SSE100440	ADAPTOR-SENSOR ANTILOCK BRAKES	13.02	15.30
STC001007EVA	MASTER CYLINDER- CLUTCH	ENQUIRE	
STC001007EVA	CLUTCH MASTER CYL MGB'68>	39.95	46.94
STC100083	MASTER CYLINDER CLUTCH	106.77	125.45
STC100083P	MASTER CYLINDER CLUTCH	48.08	56.49
STC105480	MAS CYLINDER/PIPE ASSY-CLUTCH PRE	188.53	221.52
STC4171A	SEALANT	12.52	14.71
STC434	OE*ENGINE/MOUNTING RUBBER	8.75	10.28
STC434P	ENGINE/MOUNTING RUBBER	1.95	2.29
STC50424AA	OE*CONTROL ASSY - PARKING	403.22	473.78
STC8247AA	OE*OE BULB KIT - TOURING	17.60	20.68
STC8247AAP	BULB KIT-TOURING	8.83	10.38
STG000080	PIPE ASSY CLUTCH	22.69	26.66
STG100762	PIPE ASSY CLUTCH	22.28	26.18
STG100772	PIPE ASSY CLUTCH	20.22	23.76
STG101010	PIPE ASSY CLUTCH	25.65	30.14
STH100170	HOSE CLUTCH	23.83	28.00
STN127P	ANTI-RUN ON VALVE MGB	50.21	59.00
STW000010	KIT-FLUID RESERVOIR	7.96	9.35
STY000020	KIT-REPAIR CLUTCH MASTER CYLINDER	17.58	20.66
SUC100282PMA	PEDAL ASSY-CLUTCH	31.22	36.68
SUC100292PMA	PEDAL ASSY-CLUTCH	ENQUIRE	
SK110350	BOLT	1.24	1.46
SXP000060	CARRIER-REAR CALIPER LH	49.68	58.37
SXP000070	CARRIER-REAR CALIPER RH	83.14	97.69
SYG100510L	OE*BOLT-BANJO	2.66	3.13
T2EK79251	USE RUD100150P		
T2EK79317	USE S4R16250		
T2EK79318	USE S4R16251		
TBB100760	DIFFERENTIAL ASSY	266.27	312.87
TBF100080	CASE-DIFFERENTIAL	111.90	131.48
TBN100010	SHAFT-PINION-DIFF	19.68	23.12
TBS000040	BUSH-DIFF MOUNTING MG ZT260/75 V8	21.27	24.91
TCB100260	GEAR-DIFFERENTIAL	7.67	9.09
TCC100120	PINION-DIFFERENTIAL-SIDE TRANS	37.53	44.10
TDB100447P	RH DRIVESHAFT (XPART/SHAFTEC RECON)	46.81	55.00
TDB10047P	LH DRIVESHAFT (XPART/SHAFTEC RECON)	46.81	55.00
TDC000110	SHAFT & JOINT ASSY INNER	166.99	196.21
TDC000110	SHAFT & JOINT ASSY INNER	163.79	192.45
TDC100630	SHAFT & JOINT ASSY INNER	253.61	297.99
TDC100640	USE TDC100640E		
TDC100640E	SHAFT & JOINT ASSY INNER	259.34	304.72
TFD10015	KIT-DYNAMIC DAMPER	12.01	14.11
TDJ100360EVA	USE TDJ100360SLP		
TDJ100360SLP	JOINT-CONSTANT VELOCITY	53.62	63.00
TDJ100590	JOINT ASSY-OUTER DRIVESHAFT	150.77	177.15
TDJ100590P	JOINT ASSY-OUTER DRIVESHAFT	66.38	78.00

WEB ORDER - YOU SHOP - WE DELIVER. www.rimmerbros.co.uk

Part Number	Description	Price £ Ex VAT	Price £ Inc VAT
TDL10008	CIRCLIP	1.66	1.95
TDR000140	KIT-GAITER-OUTER JOINT DRIVESHA	12.38	14.55
TDR000140P	CV BOOT KIT	4.70	5.52
TDR000150	KIT-GAITER-INNER JOINT DRIVESHAFT	ENQUIRE	
TDR000159EVA	KIT-GAITER-OUTER JOINT DRIVESHAFT	16.61	19.52
TDR000159EVA	CV BOOT KIT	8.85	10.40
TDR000160	KIT-GAITER-INNER JOINT DRIVESHAFT	ENQUIRE	
TDR000170	KIT-GAITER-OUTER JOINT DRIVESHAFT	37.32	43.85
TDR000180	KIT-GAITER-INNER JOINT DRIVESHAFT	17.72	20.82
TDR000180P	USE EJP1509P		
TDR000190	KIT-GAITER-OUTER JOINT DRIVESHAFT	14.55	17.10
TDR000190P	KIT-GAITER-OUTER JOINT DRIVESHAFT	9.79	11.50
TDR000200	KIT-GAITER-INNER JOINT DRIVESHAFT	12.92	15.18
TDR000200P	KIT-GAITER-INNER JOINT DRIVESHAFT	9.79	11.50
TDR000230	KIT-GAITER-INNER JOINT DRIVESHAFT	12.04	14.15
TDR000230P	CV BOOT KIT	8.85	10.40
TDR000280	USE TDR000280SLP		
TDR000280SLP	KIT-GAITER-INNER JOINT DRIVESHAFT	18.55	21.80
TDR000280SLP	USE EJP1509P		
TDR001155EVA	USE TDR001155EVA		
TDR001155EVA	GAITER KIT-STD.RACK MGB	6.75	7.93
TDR10004EVA	KIT-BOOT-CONSTANT VELOCITY JOINT	5.49	6.45
TDR10004EVA	KIT-BOOT-CONSTANT VELOCITY JOINT	ENQUIRE	
TDR10005EVA	KIT-DRIVESHAFT & CIRCLIP	ENQUIRE	
TDR10005EVA	USE TDR100050P		
TDR100050EVA	KIT-GAITER-OUTER JOINT DRIVESHAFT	29.65	34.84
TDR100500EVA	USE TDR100500EVA		
TDR100510EVA	USE TDR000159EVA		
TDR100760	KIT-GAITER-OUTER JOINT DRIVESHAFT	17.00	19.98
TDR100770	KIT-GAITER-INNER JOINT DRIVESHAFT	17.29	20.32
TDR100770P	USE TDR000230P		
TDR100920	KIT-GAITER-INNER JOINT DRIVESHAFT	18.04	21.20
TDR100930	KIT-GAITER-INNER JOINT DRIVESHAFT	17.18	20.19
TDR100930P	USE TDR000230P		
TDR100940	KIT-GAITER-OUTER JOINT DRIVESHAFT	18.04	21.20
TDR100940P	CV BOOT KIT	8.99	10.56
TDR100950	KIT-GAITER-OUTER JOINT DRIVESHAFT	16.20	19.04
TDR100950P	CV BOOT KIT	8.77	10.30
TE108051	STUD M8 X 25MM	1.79	2.10
TE108065M	STUD	1.44	1.69
TE110051	STUD	1.55	1.82
TEB10001	WASHER-SEALING	0.97	1.14
TEE10001	CLAMP	0.27	0.32
TFB000070	USE TFB000070E		
TFB000070E	JOINT-CONSTANT VELOCITY	141.54	166.31
TFB000070E	SURCHARGE	100.00	117.50
TFB000070P	JOINT-CONSTANT VELOCITY (+BOOT KIT)	66.38	78.00
TFB000090	USE TFB000090SLP		
TFB000090E	JOINT-CONSTANT VELOCITY	126.61	148.77
TFB000090P	CV JOINT NEW OUTRIGHT	41.28	48.50
TFB000090SLP	USE TFB000090E		
TFB000100	USE TFB000100E		
TFB000100E	JOINT-CONSTANT VELOCITY	164.92	193.78
TFB000100P	JOINT-CONSTANT VELOCITY (NON ABS)	66.38	78.00
TFB000110	USE TFB000110E		
TFB000110E	JOINT-CONSTANT VELOCITY	169.88	199.61
TFB000110P	CV JOINT ASSY - NEW OUTRIGHT	66.38	78.00
TFB000150	JOINT-CONSTANT VELOCITY	191.78	225.34
TFB000150E	JOINT-CONSTANT VELOCITY	204.44	240.22
TFP000080	USE TFP000080E		
TFP000080E	JOINT-CONSTANT VELOCITY	70.15	82.43
TFP000080E	SURCHARGE	100.00	117.50
TGD101780E	TRANSMISSION ASSY AUTO - EXCHAN	1325.00	1556.88
TGD101780E	SURCHARGE	500.00	587.50
TGG100090	DIPSTICK ASSY-AUTO	6.33	7.44
TGJ000010	CHAMBER	40.31	47.36
TGK10014EVA	GASKET-SUMP	ENQUIRE	
TGL10012	COVER-END-TRANS	1.56	1.83
TGM10010	PAN ASSY-OIL TRANSMISSION CASE	40.37	47.43
TGM10011	KIT-STRAINER-OIL	38.21	44.90
TGM10012	KIT-COVER-AUTO TRANS	50.77	59.65
TGN100050	O RING-SPEED SENSOR AUTO TRANS	3.30	3.88
TGQ100090	CLOSURE PLATE	ENQUIRE	
TGQ100100	PLATE-CLOSURE-AUTO	6.91	8.12
TGX10002	SEAL-BEARING COVER	9.57	11.24
TGZ10001	PLUG AND MAGNET ASSY	5.98	7.03
TJM000050	PUMP-OIL	637.70	749.30
TKA4162-3	DOOR PANELS(PR)-BLACK MGB'76>	50.17	58.95
TLF10002	SEAL-OIL	5.65	6.64
TMG30705N	S/ABSORBER-FRT-U/R-NEW	119.11	139.95
TMG30705N	SURCHARGE	20.00	23.50
TMG30714LN	S/ABSORBER-RH-U/R-NEW MGB	77.40	90.95
TMG30714LN	SURCHARGE	20.00	23.50
TMG30714RN	S/ABSORBER-RH-U/R-NEW MGB	77.40	90.95
TMG30714RN	SURCHARGE	20.00	23.50
TNB100100	PINION-ASSY-SPEEDO	7.72	9.07
TNK100040	HOUSING-SPEEDO DRIVE	39.92	46.91
TPB10001	PLATE-DRIVE-AUTO	64.85	76.20
TPB100120	DRIVE-PLATE ASSY	34.04	40.00
TPB100140	DRIVE-PLATE ASSY	169.90	199.63
TPB100210	DRIVE-PLATE ASSY	63.83	75.00
TPB100300	PLATE-DRIVE-AUTO	ENQUIRE	
TRC000340	MAN TRANS-1.8 TURBO 160PS (NEW MGZT 1800	ENQUIRE	
TRC102450N	MAN TRANS-2.3 HONDA R600 2300 NON TURBO	ENQUIRE	
TRC102630N	MAN TRANS-2.0L DSL. 200/25 DIESEL	ENQUIRE	
TRC102660N	TRANS ASSY-MANUAL	905.00	1063.38
TRC102670N	TRANS ASSY-MANUAL	1046.15	1229.23
TRC102670N	SURCHARGE	300.00	352.50
TRC102680N	TRANS ASSY-MANUAL	ENQUIRE	
TRD101030	HOUSING ASSY-CLUTCH	148.88	174.93
TRF10002	BOLT-SPECIAL-CLU HOUSING MAN TRANS	1.37	1.61
TRT100050	SET-SEAL-O/HAUL-TRAN	12.77	15.00
TRT100060	SET-SEAL-O/HAUL-TRAN	37.75	44.36

Part Number	Description	Price £ Ex VAT	Price £ Inc VAT
TRV100060	PROTECTOR-SEAL	10.36	12.17
TRX100100SLP	SEAL DIFFERENTIAL	10.73	12.61
TSB100190	SHAFT-SHIFT PIECE MANUAL TRANS	34.03	39.99
TSB100250	SHAFT-SELECTR-MANUAL	ENQUIRE	
TSB100440	SHAFT ASSY-TRANS	36.43	42.81
TSP100170	FORK ASSY-5TH-MANUAL	57.54	67.61
TSP100210	FORK ASSY 1/2ND MAN	60.00	70.50
TSP100330A	FORK ASSY-3/4-MANUAL	78.38	87.40
TSW100070A	INTERLOCK ASSY	6.54	7.68
TTE100020	BOLT-SPECIAL MANUAL TRANSMISSION	0.27	0.32
TTK100120	PIECE ASSY-SHIFT MANUAL TRANSMISSION	37.89	44.52
TTK100170A	PIECE ASSY-MANUAL	5.14	6.04
TTL100150	HOLDER-CHANGE-MAN	13.11	15.40
TTL100170A	HOLDER-REVERSE CNHG	34.28	40.28
TUB101760	GEAR-REVERSE IDLER MANUAL TRANS	69.44	81.59
TUD102170	SHAFT-MAIN-MANUAL	67.55	79.37
TUF100080	WASHER-THRUST	1.78	2.09
TUK10009	BEARING-NEEDLE ROLLR	13.56	15.93
TUK10010	BEARING-NEEDLE ROLLR	9.50	11.16
TUK10011	BEARING-NEEDLE ROLLR	15.57	18.29
TVC100010	OE*UNIVERSAL JOINT	45.13	53.03
TVC100010P	UNIVERSAL JOINT	7.87	9.25
TXF100090	GEAR-SPEEDOMETER DRIVE	33.48	39.34
TXG100170	GEAR ASSY-SPEEDOMETER	45.01	52.89
TYB10001	PLUG-BLANKING	0.23	0.27
TYB10002	PLUG-BLANKING	1.33	1.56
TYF000170	WASHER	5.72	6.72
TYH000240	NUT	10.20	11.99
TYT100100	PIN-ROLL	1.26	1.48
TYX000140	O RING-OIL PUMP SEAL	10.47	12.30
TYX000150	O RING	5.66	6.65
TYX10010	O RING	1.78	2.09
TYX10011	O RING	0.17	0.20
TYX10012	O RING	3.87	4.55
TYX10013	O RING	1.14	1.34
TZB10003	SEAL	14.71	17.28
TZB10004	WASHER-COPPER	0.13	0.15
TZB10005	WASHER-COPPER	0.17	0.20
TZB10006	SEAL	10.14	11.91
TZX000030	TUBE	4.68	5.50
TZZ000100	BEARING-PRIMARY SHAFT	22.26	26.16
UAM1599EVA	BELT-DRIVE-TIMING	11.16	13.11
UAM1805	PUMP OIL	ENQUIRE	
UAM3797L	OE*CAP - VALVE STEM	6.52	7.66
UAM5100	USE LPF000132EVA		
UCB101100	MECHANISM ASSY-SELECTOR AUTO	198.49	233.23
UCK000150WCV	HANDLE SELECTOR ME		

Part Number	Description	Price £ Ex VAT	Price £ Inc VAT
UQB000221P	PLATE-CLUTCH-DRIVEN.		ENQUIRE
UQB000280	CLUTCH	114.91	135.02
UQB000380	PLATE-CLUTCH-DRIVEN.	83.77	98.43
UQB000380PK	USE RP1067(2L)RP1068(2.5/1.8T) RP1069(D)		
UQB090825EVA	USE URF009100EVA		
UQB10002EVA	USE URF009100EVA		
UQB10009EVA	KIT-CLUTCH	74.89	88.00
UQB10017	PLATE-CLUTCH-DRIVEN	87.31	102.59
UQB10017EVA	USE URF009775EVA		
UQB10020EVA	USE URF009065EVA		
UQB10021EVA	USE URF009065EVA		
UQB10022EVA	USE URF009065EVA		
UQB10024EVA	USE URF006605EVA		
UQB10028EVA	USE URF006604EVA		
UQB100560EVA	USE URF009539EVA		
UQB100692	PLATE-CLUTCH-DRIVEN.	118.03	138.69
UQB100720	PLATE-CLUTCH-DRIVEN.	69.07	81.16
UQB100750	PLATE-CLUTCH-DRIVEN		ENQUIRE
UQB100772	LATE-CLUTCH-DRIVEN.	115.14	135.29
UQB100973	PLATE-CLUTCH-DRIVEN.	99.34	116.72
UQB100980	USE URF000170		
URB000170	COVER-CLUTCH ASSY	122.45	143.88
URB000170P	COVER-CLUTCH ASSY	40.00	47.00
URB000190	COVER-CLUTCH ASSY	105.51	123.97
URB000470	CLUTCH	389.81	458.03
URB090272EVA	USE URF009100EVA		
URB10009	COVER-CLUTCH ASSY	115.14	135.29
URB10009P	COVER-CLUTCH ASSY	29.79	35.00
URB10014EVA	USE URF009065EVA		
URB10033	COVER-CLUTCH ASSY		ENQUIRE
URB10034	COVER-CLUTCH ASSY	80.60	94.71
URB10035	OE-CLUTCH COVER	83.55	98.17
URB10035P	CLUTCH COVER	47.22	55.48
URB100440	CLUTCH ASSY		ENQUIRE
URB100652	COVER CLUTCH	101.73	119.53
URB100702	COVER CLUTCH	99.34	116.72
URB100851	COVER CLUTCH	101.73	119.53
URD090115EVA	CLUTCH & FLYWHEEL ASSY	196.95	231.42
URD090115EVA	CLUTCH KIT	126.96	149.18
URD10010EVA	USE URF006604EVA		
URD10011EVA	CLUTCH & FLYWHEEL ASSY		ENQUIRE
URD10011EVA	CLUTCH KIT	102.08	119.94
URD100210EVA	CLUTCH & FLYWHEEL ASSY	183.56	215.68
URD100210EVA	CLUTCH KIT	80.00	94.00
URF000030	USE URF000190		
URF000050	USE URF000170		
URF000060	KIT-CLUTCH	195.88	230.16
URF000121	KIT-CLUTCH	151.22	177.68
URF000121P1	CLUTCH KIT MGF 1.8 OEM	109.63	128.82
URF000131	KIT-CLUTCH	159.59	187.52
URF000131P	CLUTCH KIT	108.08	126.99
URF000140	KIT-CLUTCH	214.83	252.43
URF000141	KIT-CLUTCH	269.83	317.05
URF000141P	KIT-CLUTCH	225.00	264.38
URF000150	KIT-CLUTCH	174.95	205.57
URF000150P	KIT-CLUTCH	115.73	135.98
URF000160	KIT-CLUTCH	293.55	344.92
URF000160P	CLUTCH KIT-MGF 1.6	80.00	94.00
URF000170	KIT-CLUTCH	151.22	177.68
URF000170P	CLUTCH KIT	64.68	76.00
URF000180	KIT-CLUTCH	225.23	264.65
URF000190	KIT-CLUTCH	127.07	149.31
URF006338EVA	KIT-CLUTCH	69.47	81.63
URF006338EVA	CLUTCH KIT	51.90	60.98
URF006518EVA	USE URF006518EVA		
URF006518EVA	CLUTCH KIT	130.82	153.71
URF006557EVA	KIT-CLUTCH	87.92	103.31
URF006557EVA	CLUTCH KIT	62.13	73.00
URF006604EVA	KIT-CLUTCH	101.38	119.12
URF006605EVA	KIT-CLUTCH	175.40	206.10
URF006605EVA	CLUTCH KIT	149.95	176.19
URF008150EVA	KIT-CLUTCH	135.88	159.66
URF008652EVA	KIT-CLUTCH	144.90	170.26
URF008855EVA	KIT-CLUTCH	67.92	79.81
URF008855EVA	CLUTCH KIT MINI-DIAPHRAGM TYPE	48.51	57.00
URF009065EVA	KIT-CLUTCH	106.95	125.67
URF009065EVA	USE F3HK9065		
URF009100EVA	KIT-CLUTCH	97.49	114.55
URF009100EVA	CLUTCH KIT	77.06	90.55
URF009203EVA	KIT-CLUTCH	106.95	125.67
URF009203EVA	USE F3HK9203		
URF009539EVA	KIT-CLUTCH	166.47	195.60
URF009539EVA	USE F3HK9539		
URF009775EVA	KIT-CLUTCH	106.95	125.67
URF009775EVA	CLUTCH KIT	67.23	79.00
URF009978EVA	KIT-CLUTCH	138.00	162.15
URF009978EVA	CLUTCH KIT	129.45	152.10
URF100010EVA	USE URF009539EVA		
USB100120EVA	USE URF009539EVA		
UTB100140	FORK-CLUTCH RELEASE	46.05	54.11
UTC100100	SHAFT & LEVER ASSY	41.86	49.19
UTJ000020	BEARING-CLUTCH RELEASE	34.63	40.69
UTJ100080EVA	CLUTCH RELEASE BEARING	42.55	50.00
UTJ100100	BEARING-CLUTCH RELEASE	34.72	40.80
UTJ100170	OE*CLUTCH RELEASE BEARING	26.65	31.31
UTJ100170P	CLUTCH RELEASE BEARING	13.27	15.59
UUB100040	SLAVE CYLINDER CLUTCH	72.08	84.69
UUB100040P	SLAVE CYLINDER CLUTCH	35.00	41.13
UUB100180	KIT-REPAIR CLUTCH SLAVE CYLINDER	5.70	6.70
UUB100193	SLAVE CYLINDER & PIPE ASSY CLUTCH-PR	158.75	186.53

Part Number	Description	Price £ Ex VAT	Price £ Inc VAT
UUB100193P	SLAVE CYLINDER & PIPE ASSY CLUTCH-PR	74.75	87.83
UUB105301	SLAVE CYLINDER CLUTCH	158.75	186.53
UUB105301P	SLAVE CYLINDER CLUTCH	111.49	131.00
UUC000040	CABLE-RELEASE MECHANISM CLUTCH	55.03	64.66
UUC000040P	CLUTCH CABLE		ENQUIRE
UUC000050	CABLE-RELEASE MECHANISM CLUTCH	57.54	67.61
UUC007067EVA	CABLE-CLUTCH	26.89	31.60
UUC007067EVA	CLUTCH CABLE	18.08	21.24
UUC10019EVA	CABLE-CLUTCH	35.22	41.38
UUC10049EVA	CABLE-CLUTCH	39.68	46.62
UUC10052EVA	CABLE-CLUTCH	23.46	27.57
UUC10052EVA	CLUTCH CABLE	18.72	22.00
UUC10054EVA	CABLE-CLUTCH	36.22	42.56
UUC10062EVA	CABLE-CLUTCH	41.07	48.26
UUC10062EVA	CLUTCH CABLE	27.61	32.44
UUC101240	CABLE-RELEASE MECHANISM CLUTCH	43.07	50.61
UUC101240P	CLUTCH CABLE	23.85	28.02
UUC101250	CABLE-RELEASE MECHANISM CLUTCH	44.72	52.55
UUC101260	CABLE-RELEASE MECHANISM CLUTCH	43.68	51.32
UUC101260P	CLUTCH CABLE	34.47	40.50
UUC101270	CABLE-RELEASE MECHANISM CLUTCH	44.77	52.60
UUU100650	BRKT ASSY-CL/SL/CYL		ENQUIRE
VDC000140EN	ROVER 25 HANDBOOK	33.00	33.00
VDC000150EN	ZR HANDBOOK	31.35	36.84
VDC000160EN	ROVER 45 HANDBOOK	33.00	33.00
VDC000170EN	ZS HANDBOOK	33.00	33.00
VDC000180EN	ROVER 75 HANDBOOK	33.00	33.00
VDC000190EN	ZT HANDBOOK	33.00	33.00
VDC000320EN	MGT/ HANDBOOK	34.66	34.66
VDC000321EN	MGT/ HANDBOOK	33.00	33.00
VDC000340EN	ZT HANDBOOK		ENQUIRE
VDC000350EN	ROVER 75 HANDBOOK	33.00	38.78
VDC000360EN	ROVER 25 HANDBOOK		ENQUIRE
VDC000370EN	ZR HANDBOOK	31.89	37.47
VDC000380EN	ROVER 45 HANDBOOK	22.07	22.07
VDC000390EN	ZS HANDBOOK		ENQUIRE
VDC000400EN	ROVER 25 HANDBOOK	33.00	33.00
VDC000410EN	ROVER 45 HANDBOOK	33.00	38.78
VDC000420EN	ROVER 75 HANDBOOK	33.00	38.78
VDC000430EN	ZR HANDBOOK	33.00	38.78
VDC000440EN	ZS HANDBOOK	33.00	33.00
VDC000450EN	ZT HANDBOOK	33.00	38.78
VDC000460EN	ROVER 25 HANDBOOK	31.35	36.84
VDC000461EN	ROVER 25 HANDBOOK	33.00	33.00
VDC000470EN	ZR HANDBOOK	31.35	31.35
VDC000471EN	ZR HANDBOOK	33.00	33.00
VDC000480EN	ROVER 75 HANDBOOK	31.35	31.35
VDC000490EN	ZT HANDBOOK	33.00	38.78
VDC000500EN	ROVER 45 HANDBOOK	33.00	33.00
VDC000510EN	ZS HANDBOOK	33.00	33.00
VDC000520EN	STREETWISE HANDBOOK	33.00	33.00
VDC000530EN	PACK-LITERATURE	29.06	29.06
VDC000540EN	ZT 260 HANDBOOK	32.05	37.66
VDC000550EN	PACK-LITERATURE		ENQUIRE
VDC000560EN	PACK-LITERATURE	18.86	18.86
VDC000570EN	PACK-LITERATURE	17.92	17.92
VDC000580EN	ROVER 25 HANDBOOK	33.00	33.00
VDC000590EN	ZR HANDBOOK	31.35	36.84
VDC000600EN	ROVER 45 HANDBOOK	33.00	38.78
VDC000610EN	ZS HANDBOOK	33.00	33.00
VDC000620EN	STREETWISE OWNERS HANDBOOK	33.00	33.00
VDH101280ENG	MGF HANDBOOK	29.64	29.64
VDS000010	FLUID-AUTOMATIC TRANSMISSION	29.59	34.77
VDS000020	FLUID-AUTOMATIC TRANSMISSION		ENQUIRE
VEE106000	ADHESIVE PEN		ENQUIRE
VEP100220	PAINT-PENCIL	8.01	9.41
VEP100220P	ROVER TAHTI BLUE TOUCH-UP 125ml	3.73	4.38
VTF100000	RACK-TRUNK MOUNTED	199.28	234.15
VTF100000P	LUGGAGE RACK-TRUNK MOUNTED		ENQUIRE
VTF100050	RACK-TRUNK MOUNTED		ENQUIRE
VTG100010	CARRIER-SKI-TRUNK		ENQUIRE
VTH100060	WHEEL-STEERING-LUX	262.15	308.03
VTM100000	BOX-WEEKENDER	203.48	239.09
VTW100010	PARCEL SHELF-FRONT	41.15	48.35
VUB000090	KIT-FITTING-HARDTOP	15.52	18.24
VUB001060	OE*KIT - HALOGEN BLUE BULBS	27.53	32.35
VUB002690LML	KIT-REAR BUMPER SPOILER	31.70	37.25
VUB002890	KIT-BULB	16.44	19.32
VUB002900	GRILLE-FRONT		ENQUIRE
VUB002990LML	KIT - SPORTS SIDE SILL	33.70	39.60
VUB003020LML	KIT - SPORTS SIDE SILL	22.55	26.50
VUB003060	KIT-TOWING	118.34	139.05
VUB003060P	TOWBAR R75/MGZT+TOURER(TOWSURE)	97.87	115.00
VUB003110	KIT HEATED SEAT		ENQUIRE
VUB003120	LINK KIT ACCESSORIES		ENQUIRE
VUB003280	LINK LEAD	3.18	3.74
VUB003300MBE	SPEEDSTER HOOP-KIT		ENQUIRE
VUB100160	SENSOR	40.48	47.56
VUB100220	JET ASSY-HTD-W/SCREEN	71.21	83.67
VUB100230	GAUGE-TEMPERATURE	42.18	49.56
VUB101340P	KIT-HARD TOP-STOWAGE	23.69	27.84
VUB102110	HEATED WASHER JET	20.46	24.04
VUB102850	USE VUB111860		
VUB104420	KIT-PARKING AID		ENQUIRE
VUB104430	KIT-PARKING AID	170.64	200.50
VUB104560	TOW-ELECTRICS-13 PIN	42.55	50.00
VUB104600	TOW-ELECTRICS-13 PIN	42.55	50.00
VUB104650	WIND-DEFLECTORS	31.67	37.21
VUB104660	WIND-DEFLECTORS	30.86	36.26
VUB104670	WIND-DEFLECTORS	41.39	48.63

Part Number	Description	Price £ Ex VAT	Price £ Inc VAT
VUB105120	FACIA ASSY	225.94	265.48
VUB105120P	USE RP1092CARBON		
VUB105130	KIT-VENEER FACIA.	202.97	238.49
VUB105140	KIT-VENEER FACIA.	225.33	264.76
VUB105300	KIT-GRILLE		ENQUIRE
VUB105510	KIT-CONVERTIBLE HOOD POWER	437.06	513.55
VUB105580	GRIP-HANDBRAKE	30.57	35.92
VUB105600	KIT-CD	39.66	46.60
VUB105670	CRUISE CONTROL		ENQUIRE
VUB105690	KIT-CHROME TRIM		ENQUIRE
VUB105880	KIT-VENEER FACIA.	198.01	232.66
VUB105880P	USE RP1093WALNUT		
VUB105890	KIT-VENEER FACIA.	113.19	133.00
VUB105900	KIT-VENEER FACIA.	126.66	148.83
VUB105900P	USE RP1093ALLOY		
VUB105910	KIT-VENEER FACIA.	300.04	352.55
VUB105910P	RP1093CARBON		ENQUIRE
VUB105920	KIT-TRIM PARTS	32.34	38.00
VUB105950	LENS-SIDE REPEATER	99.94	117.43
VUB105980LML	KIT-TRIM-PARTS	92.36	108.52
VUB106010LNF	KIT-INTERIOR TRIM	21.25	24.97
VUB106010OSD	KIT-INTERIOR TRIM		ENQUIRE
VUB106050	KIT-INTERIOR TRIM	99.85	117.32
VUB111860	WIND-DEFLECTORS		ENQUIRE
VUB111900	CARRIER-CYCLE-TRUNK	202.53	237.97
VUB111910	CARRIER-CYCLE-TRUNK		ENQUIRE
VUB112220	GRIP-HANDBRAKE	34.48	40.51
VUB112420	LINER-CARPET-L/SPACE	18.89	22.20
VUD100100	KIT-FITTING-RADIO		ENQUIRE
VUD100380	KIT-FITTING-CD	23.06	27.10
VUF000010	XPOWER DIESEL UPGRADE	199.99	234.99
VUH00030	USE VUH000030		
VUJ000040	SET-SNOW CHAINS	143.19	168.25
VUJ10002	SNOW CHAINS	75.19	88.35
VUJ100030	SET-SNOW CHAINS	101.38	119.12
VUK100030PMA	COVER-HARDTOP	72.27	84.92
VUK100040PMA	COVER-PROT-FR SEAT	17.12	20.12
VUK100070CMS	COVER-TUNNEL CONSOLE		ENQUIRE
VUK100070LDP	COVER-TUNNEL CONSOLE	45.95	53.99
VUK100070VAC	COVER-TUNNEL CONSOLE	84.57	99.37
VUP100030	BAG-ACCESSORY	116.81	137.25
VUP100060	BAG-ACCESSORY		ENQUIRE
VUP100090	BAG-ACCESSORY	21.28	25.00
VUQ100280	WIND DEFLECTOR (DRILL TO FIT)	176.33	207.19
VUQ100280P	WIND DEFLECTOR (NO DRILLING REQ)	153.19	180.00
VUS100060	USE VUS100060PMA		
VUS100060PMA	PROTECTOR-WINDSCREEN		ENQUIRE
VUS1000700UTDOOR	USE RP1045		

WAG103700-WCG000291

Part Number	Description	Price £ Ex VAT	Price £ Inc VAT
WAG103700	CATALYTIC CONVERTER ENGINE EXHAUST	248.08	291.49
WAG103700P	CATALYTIC CONVERTER	66.19	77.77
WAG103761	CATALYTIC CONVERTER ENGINE EXHAUST	210.60	247.46
WAG103761P	CATALYTIC CONVERTER	52.46	61.64
WAG103850EVA	CONVERTER-CATALYST	193.06	226.85
WAG103850EVA	USE WAG104790P		
WAG103910EVA	USE WAG103910SLP		
WAG103910SLP	CATALYTIC CONVERTER ENGINE EXHAUST	170.77	200.65
WAG103910SLPP	CATALYTIC CONVERTER	74.89	88.00
WAG103970EVA	CONVERTER-CATALYST	133.74	157.14
WAG103970EVA	CATALYTIC CONVERTER	62.99	74.01
WAG103990EVA	CONVERTER-CATALYST	191.85	225.42
WAG104070SLP	USE WAG103651		
WAG104530	CATALYTIC CONVERTER ASSY	248.08	291.49
WAG104640	CATALYTIC CONVERTER ENGINE EXHAUST	350.00	411.25
WAG104790	CATALYTIC CONVERTER ASSY	200.00	235.00
WAG104790P	CATALYST	69.05	81.13
WAM1460	DOWEL	2.02	2.37
WAM1465	USE WAM1465L		
WAM1465L	OE'DOWEL	1.74	2.04
WAM1959	SCREW-CONNECTING ROD DOWEL	1.60	1.88
WAM2293	BOLT-CYLINDER HEAD FIXING	6.38	7.50
WAM2293 KIT	HEAD BOLT SET *OE* (10 BOLTS)	41.15	48.35
WAM2293P	HEAD BOLT	3.83	4.50
WAM2293P KIT	HEAD BOLT SET (10 BOLTS)	25.49	29.95
WAM2492	WASHER-CRANKSHAFT THRUST	2.52	2.96
WAM2804	BELT-ENGINE TIMING	28.77	33.80
WAM2804P	TIMING BELT	17.14	20.14
WAM3719	NUT	1.53	1.80
WAM3885	BOLT-TIMING BELT TENSIONER PEDESTAL	3.09	3.63
WAM4026200	BEARING-MAIN	4.03	4.74
WAM4026BLU	BEARING-HALF MAIN PL	3.56	4.18
WAM4026GRE	BEARING-HALF MAIN PL	4.03	4.74
WAM4026RED	USE WAM4026200		
WAM4027200	BEARING-HALF MAIN GR	3.79	4.45
WAM4027BLU	BEARING-HALF MAIN GROOVED.	3.66	4.30
WAM4027GRE	BEARING-HALF MAIN GR	3.79	4.45
WAM4116EVA	GASKET-CAMSHAFT COVER	9.36	11.00
WAM4243	BOLT-CRANKSHAFT PULLEY	4.36	5.12
WAV100420	USE 8510381		
WCD000106EVA	EXHAUST	36.67	43.09
WCD000106EVA	EXHAUST SYSTEM-SINGLE BOX MINI	29.95	35.19
WCD000106EVA	EXH.SYST.SINGLE BOX (2 SECTIONS)	30.24	35.53
WCD000140	DOWNPIPE ASSY EXHAUST SYSTEM	80.25	94.29
WCD000140SLP	DOWNPIPE ASSY EXHAUST SYSTEM	96.27	113.12
WCD000140SLPP	EXHAUST	52.77	62.00
WCD000150SLP	DOWNPIPE ASSY EXHAUST SYSTEM	108.13	127.05
WCD000150SLPP	DOWNPIPE ASSY EXHAUST SYSTEM	67.23	79.00
WCD000220	MANIFOLD/STARTER CAT	119.95	140.94
WCD000220SLP	MANIFOLD/STARTER CATALYST ASSY	121.01	142.19
WCD000280	OE'DOWNPIPE ASSY	151.79	178.35
WCD000280P	DOWNPIPE ASSY - AFTERMARKET		ENQUIRE
WCD000390	OE'DOWNPIPE ASSY	143.48	168.59
WCD000390P	DOWNPIPE ASSY - AFTERMARKET	99.95	117.44
WCD000400	DOWNPIPE ASSY EXHAUST SYSTEM		ENQUIRE
WCD000400P	USE WCD106550P		
WCD001070SLP	DOWNPIPE ASSY EXHAUST SYSTEM	335.61	394.34
WCD001650SLP	DOWNPIPE ASSY EXHAUST SYSTEM	100.16	117.69
WCD001780	DOWNPIPE ASSY EXHAUST SYSTEM	313.63	368.52
WCD001780P	USE WCD106550P		
WCD001791	CONVERTER ASSY-MANIFOLD EXHAUST	461.43	542.18
WCD001811	CONVERTER ASSY-MANIFOLD EXHAUST	178.60	209.86
WCD001811P	USE WCD001811		
WCD001840	DOWNPIPE ASSY-EXHAUST MANIFOLD	183.96	216.15
WCD001850	USE WCD001851		
WCD001851	DOWNPIPE ASSY EXHAUST SYSTEM	223.31	262.39
WCD001851P	CATALYST	165.96	195.00
WCD001860	DOWNPIPE ASSY EXHAUST SYSTEM	174.99	205.61
WCD001870	DOWNPIPE ASSY EXHAUST SYSTEM		ENQUIRE
WCD001880	USE WCD001881		
WCD001881	DOWNPIPE ASSY EXHAUST SYSTEM	283.49	333.10
WCD001890	DOWNPIPE ASSY EXHAUST SYSTEM	178.60	209.86
WCD001890P	CATALYST	142.98	168.00
WCD001900	USE WCD001901		
WCD001900P	USE WCD001890P		
WCD001901	DOWNPIPE ASSY-EXHAUST SYSTEM	173.64	204.03
WCD001920P	CATALYST	104.31	122.56
WCD001930	DOWNPIPE ASSY EXHAUST SYSTEM	204.41	240.18
WCD001940	DOWNPIPE ASSY EXHAUST SYSTEM	248.08	291.49
WCD003911EVA	PIPE-FRONT	19.12	22.47
WCD011013EVA	DOWNPIPE ASSY EXHAUST SYSTEM	31.14	36.59
WCD011074EVA	PIPE-FRONT	10.64	12.50
WCD011097EVA	DOWNPIPE ASSY EXHAUST SYSTEM	65.74	77.24
WCD033052EVA	DOWNPIPE ASSY EXHAUST SYSTEM		ENQUIRE
WCD033500EVA	DOWNPIPE ASSY EXHAUST SYSTEM	25.90	30.43
WCD033672EVA	DOWNPIPE ASSY EXHAUST SYSTEM	98.54	115.78
WCD033672EVA	DOWNPIPE ASSY EXHAUST SYSTEM	82.55	97.00
WCD10012EVA	DOWNPIPE ASSY EXHAUST SYSTEM	44.61	52.42
WCD10012EVA	EXHAUST FRONT PIPE	38.30	45.00
WCD10033EVA	DOWNPIPE ASSY EXHAUST SYSTEM	92.85	109.10
WCD10033EVA	DOWNPIPE ASSY EXHAUST SYSTEM	80.00	94.00
WCD10034EVA	DOWNPIPE ASSY EXHAUST SYSTEM	93.47	109.83
WCD10034EVA	DOWNPIPE ASSY-EXHAUST SYSTEM	77.45	91.00
WCD10039EVA	DOWNPIPE ASSY EXHAUST SYSTEM	4.97	5.84
WCD10057EVA	DOWNPIPE ASSY EXHAUST SYSTEM	12.77	15.00
WCD10061EVA	EXHAUST-REAR ASSY	45.98	54.03
WCD10061EVA	REAR EXHAUST ASSY	34.89	41.00

WEB ORDER - YOU SHOP - WE DELIVER. www.rimmerbros.co.uk

Part Number	Description	Price £ Ex VAT	Price £ Inc VAT
WCD10075EVA	DOWNPIPE ASSY EXHAUST SYSTEM	55.54	65.26
WCD10111EVA	DOWNPIPE ASSY EXHAUST SYSTEM	49.23	57.85
WCD10122EVA	DOWNPIPE ASSY EXHAUST SYSTEM	25.53	30.00
WCD10136EVA	PIPE-FRONT	91.40	107.40
WCD10138EVA	DOWNPIPE ASSY EXHAUST SYSTEM	106.78	125.47
WCD10149EVA	DOWNPIPE ASSY EXHAUST SYSTEM	17.02	20.00
WCD10150EVA	DOWNPIPE ASSY EXHAUST SYSTEM	17.08	20.07
WCD10184EVA	DOWNPIPE ASSY EXHAUST SYSTEM		ENQUIRE
WCD10185EVA	DOWNPIPE ASSY EXHAUST SYSTEM	62.37	73.28
WCD10194EVA	DOWNPIPE ASSY EXHAUST SYSTEM	82.47	96.90
WCD10195EVA	DOWNPIPE ASSY EXHAUST SYSTEM	98.97	116.29
WCD10195EVA	EXHAUST PIPE	83.95	98.64
WCD10195EVA	EXH.FRONT PIPE S/S		ENQUIRE
WCD10197EVA	DOWNPIPE ASSY EXHAUST SYSTEM	81.41	95.66
WCD10200EVA	EXHAUST	99.20	116.56
WCD10200EVA	FRONT PIPE	53.62	63.00
WCD10216EVA	PIPE-FRONT	84.16	98.89
WCD10227EVA	DOWNPIPE ASSY EXHAUST SYSTEM	87.98	103.38
WCD10227EVA	DOWNPIPE ASSY EXHAUST SYSTEM	59.56	69.98
WCD10229EVA	DOWNPIPE ASSY EXHAUST SYSTEM	50.71	59.58
WCD10261EVA	DOWNPIPE ASSY EXHAUST SYSTEM	54.09	63.56
WCD10261EVA	EXHAUST FRONT PIPE	42.13	49.50
WCD10270EVA	DOWNPIPE ASSY EXHAUST SYSTEM	84.35	99.11
WCD10270EVA	DOWNPIPE ASSY EXHAUST SYSTEM	67.23	79.00
WCD10272EVA	DOWNPIPE ASSY EXHAUST SYSTEM	89.42	105.07
WCD10273EVA	DOWNPIPE ASSY EXHAUST SYSTEM	86.84	102.04
WCD10273EVA	DOWNPIPE ASSY EXHAUST SYSTEM	66.38	78.00
WCD102830EVA	DOWNPIPE ASSY EXHAUST SYSTEM	81.71	96.01
WCD102830EVA	DOWNPIPE ASSY EXHAUST SYSTEM	74.89	88.00
WCD103160EVA	DOWNPIPE ASSY EXHAUST SYSTEM	75.09	88.23
WCD103230EVA	DOWNPIPE ASSY EXHAUST SYSTEM	61.29	72.02
WCD10330EVA	DOWNPIPE ASSY EXHAUST SYSTEM	34.04	40.00
WCD103390EVA	PIPE-FRONT	110.54	129.88
WCD103390EVA	FRONT PIPE	73.19	86.00
WCD103400EVA	USE GEX33653		
WCD103550EVA	DOWNPIPE ASSY EXHAUST SYSTEM	20.30	23.85
WCD103750EVA	DOWNPIPE ASSY EXHAUST SYSTEM	59.50	69.91
WCD103750EVA	DOWNPIPE ASSY EXHAUST SYSTEM	49.95	58.69
WCD103860EVA	DOWNPIPE ASSY EXHAUST SYSTEM	61.71	72.51
WCD103870	DOWNPIPE ASSY EXHAUST SYSTEM	120.12	141.14
WCD103870P	DOWNPIPE ASSY EXHAUST SYSTEM	89.36	105.00
WCD103910EVA	USE WCD103911EVA		
WCD103911EVA	DOWNPIPE ASSY EXHAUST SYSTEM	99.20	116.56
WCD103911EVA	DOWNPIPE ASSY EXHAUST SYSTEM	77.45	91.00
WCD104200	DOWNPIPE ASSY EXHAUST SYSTEM	102.18	120.06
WCD104200P	DOWNPIPE ASSY EXHAUST SYSTEM	68.08	79.99
WCD104210	DOWNPIPE ASSY EXHAUST SYSTEM	99.03	116.36
WCD104220	DOWNPIPE ASSY EXHAUST SYSTEM	121.62	142.90
WCD104220P	EXHAUST FRONT PIPE	80.32	94.38
WCD104240	USE WCD104241		
WCD104241	DOWNPIPE ASSY EXHAUST SYSTEM	106.30	124.90
WCD104260P	DOWNPIPE ASSY EXHAUST SYSTEM	102.57	120.52
WCD104260P	DOWNPIPE ASSY EXHAUST SYSTEM	79.95	93.94
WCD104260P	DOWNPIPE ASSY EXHAUST SYSTEM	5.98	7.03
WCD104420	DOWNPIPE ASSY EXHAUST SYSTEM	102.18	120.06
WCD104420P	DOWNPIPE ASSY EXHAUST SYSTEM	79.95	93.94
WCD104840	DOWNPIPE ASSY EXHAUST SYSTEM	102.18	120.06
WCD104840P	EXHAUST FRONT PIPE	91.33	107.31
WCD104860	DOWNPIPE ASSY EXHAUST SYSTEM	103.21	121.27
WCD104860P	DOWNPIPE ASSY EXHAUST SYSTEM	80.85	95.00
WCD105250	DOWNPIPE ASSY EXHAUST SYSTEM	104.37	122.63
WCD105250P	EXHAUST PIPE	51.90	60.98
WCD105700	DOWNPIPE ASSY EXHAUST SYSTEM	91.96	108.05
WCD105700P	EXHAUST FRONT PIPE	76.24	89.58
WCD106000	USE WCD106001		
WCD106001	OE'DOWNPIPE ASSY	133.94	157.38
WCD106010P	DOWNPIPE ASSY - AFTERMARKET	90.21	106.00
WCD106090	USE WCD106091		
WCD106091	OE'DOWNPIPE ASSY	152.14	176.76
WCD106100	DOWNPIPE ASSY		ENQUIRE
WCD106550	DOWNPIPE ASSY EXHAUST SYSTEM	491.29	577.27
WCD106550P	CATALYTIC CONVERTER	248.53	292.02
WCE000290	INTERMEDIATE/REAR ASSY EXHAUST SYSTEM		ENQUIRE
WCE000300	INTERMEDIATE ASSY EXHAUST SYSTEM	93.51	109.87
WCE000300P	USE WCE105300P		
WCE000440	USE WCE000440P		
WCE000440P	INTERMEDIATE ASSY EXHAUST SYSTEM	79.15	93.00
WCE000460	INTERMEDIATE ASSY EXHAUST SYSTEM	80.70	94.82
WCE000460P	USE WCE110540P		
WCE000460SLP	INTERMEDIATE ASSY EXHAUST SYSTEM	79.39	93.28
WCE000530	INTERMEDIATE ASSY EXHAUST SYSTEM	108.93	127.99
WCE000711	EXHAUST-INTERMEDIATE REAR	335.26	393.93
WCE000721	USE WCE000721P		
WCE000721P	INTERMEDIATE ASSY EXHAUST SYSTEM	395.73	464.98
WCE000850	INTERMEDIATE ASSY EXHAUST SYSTEM	313.61	368.49
WCE033225EVA	EXHAUST-INTERMEDIATE	17.02	20.00
WCE033489EVA	USE WCE033489EVA		
WCE033489EVA	EXHAUST-INTERMEDIATE	91.31	107.29
WCE033537EVA	EXHAUST-INTERMEDIATE	17.02	20.00
WCE10006EVA	EXHAUST-INTERMEDIATE	50.49	59.33
WCE10023EVA	EXHAUST REAR SECTION (CAT TYPE)		ENQUIRE
WCE10050EVA	USE WCE10050EVA		
WCE10050EVA	EXHAUST-INTERMEDIATE	77.45	91.00
WCE10109EVA	EXHAUST-INTERMEDIATE	51.09	60.03
WCE10109EVA	EXHAUST-INTERMEDIATE	40.85	48.00
WCE10116EVA	EXHAUST-INTERMEDIATE	57.76	67.87
WCE10116EVA	USE WCE103370SLPP		
WCE10126EVA	EXHAUST-INTERMEDIATE	58.17	68.35
WCE10148EVA	EXHAUST-INTERMEDIATE	28.77	33.80
WCE10148EVA	CENTRE SILENCER	21.28	25.00

Part Number	Description	Price £ Ex VAT	Price £ Inc VAT
WCE10149EVA	EXHAUST-INTERMEDIATE		ENQUIRE
WCE10150EVA	EXHAUST-INTERMEDIATE	38.66	45.43
WCE10150EVA	USE WCE10148EVA		
WCE10154EVA	EXHAUST-INTERMEDIATE	42.80	50.29
WCE10172EVA	EXHAUST-REAR ASSY	57.76	67.87
WCE10172EVA	USE WCE103370SLPP		
WCE10175EVA	EXHAUST-INTERMEDIATE	43.96	51.65
WCE10175EVA	EXHAUST-INTERMEDIATE	30.21	35.50
WCE10178EVA	EXHAUST-INTERMEDIATE	48.45	56.93
WCE10181EVA	USE WCE10181SLP		
WCE10181SLP	REAR ASSY EXHAUST SYSTEM	104.16	122.39
WCE10182EVA	EXHAUST-INTERMEDIATE	35.15	41.30
WCE102000EVA	EXHAUST-INTERMEDIATE	54.54	64.08
WCE102010EVA	EXHAUST-INTERMEDIATE	44.01	51.71
WCE102010EVA	EXHAUST INTERMEDIATE	32.34	38.00
WCE102070EVA	EXHAUST-INTERMEDIATE	21.28	25.00
WCE102130EVA	EXHAUST-INTERMEDIATE	61.12	71.82
WCE102220EVA	EXHAUST-INTERMEDIATE		ENQUIRE
WCE102390EVA	EXHAUST-INTERMEDIATE	55.00	64.63
WCE102390EVA	EXHAUST-INTERMEDIATE	41.28	48.50
WCE102400EVA	EXHAUST-INTERMEDIATE	42.35	49.76
WCE102400EVA	EXHAUST-INTERMEDIATE	32.34	38.00
WCE102450	INTERMEDIATE ASSY EXHAUST SYSTEM	79.30	93.18
WCE102500EVA	EXHAUST-INTERMEDIATE	61.19	71.90
WCE102650EVA	EXHAUST-INTERMEDIATE	7.42	8.72
WCE102690EVA	EXHAUST-INTERMEDIATE	79.35	93.24
WCE102702EVA	EXHAUST-INTERMEDIATE	47.33	55.61
WCE102711EVA	EXHAUST-INTERMEDIATE	69.99	82.24
WCE102931EVA	EXHAUST-INTERMEDIATE	60.51	71.10
WCE103080EVA	EXHAUST-INTERMEDIATE	84.59	99.39
WCE103080EVA	EXHAUST-INTERMEDIATE	46.81	55.00
WCE103180	INTERMEDIATE ASSY EXHAUST SYSTEM	74.01	86.96
WCE103180P	INTERMEDIATE ASSY EXHAUST SYSTEM	59.95	70.44
WCE103240	INTERMEDIATE ASSY EXHAUST SYSTEM	67.67	79.51
WCE103240P	EXHAUST SILENCER	43.40	51.00
WCE103250	INTERMEDIATE ASSY EXHAUST SYSTEM	53.90	63.33
WCE103250P	USE WCE110540P		
WCE103290	INTERMEDIATE ASSY EXHAUST SYSTEM	49.27	57.89
WCE103290P	EXHAUST PIPE	39.95	46.94
WCE103320EVA	EXHAUST-INTERMEDIATE	58.14	68.31
WCE103330EVA	EXHAUST-INTERMEDIATE	74.77	87.85
WCE103330EVA	EXHAUST INTERMEDIATE	53.62	63.00
WCE103340			

Part Number	Description	Price £ Ex VAT	Price £ Inc VAT
WCG000291SLP	REAR ASSY EXHAUST SYSTEM	159.42	187.32
WCG000291SLPP	EXHAUST ASSY	133.62	157.00
WCG000300	REAR ASSY EXHAUST SYSTEM	129.36	152.00
WCG000300PECO	PECO SPORT REAR EXHAUST S.O.O.	382.98	450.00
WCG000310	USE WCG000311		
WCG000311	REAR ASSY EXHAUST SYSTEM	168.72	198.25
WCG000311P	REAR ASSY EXHAUST SYSTEM	134.47	158.00
WCG000340	REAR ASSY EXHAUST SYSTEM	150.09	176.36
WCG000350	REAR ASSY EXHAUST SYSTEM		ENQUIRE
WCG000440	REAR ASSY EXHAUST SYSTEM	100.46	118.04
WCG000440P	REAR EXHAUST ASSY	77.45	91.00
WCG000460	USE WCG000460SLP		
WCG000460SLP	OE*REAR EXHAUST ASSY	173.69	204.09
WCG000460SLPP	REAR EXHAUST ASSY-AFTERMARKET	149.95	176.19
WCG000530	REAR ASSY EXHAUST SYSTEM	171.87	201.95
WCG000540	REAR ASSY EXHAUST SYSTEM	173.16	203.46
WCG000550	OE*REAR EXHAUST ASSY	392.92	461.68
WCG000560	USE WCG000560PIPER		
WCG000560PIPER	REAR SILENCER ASSY	227.23	267.00
WCG000570	REAR ASSY EXHAUST SYSTEM	168.94	198.50
WCG000580	REAR ASSY EXHAUST SYSTEM		ENQUIRE
WCG000580P	USE WCG000161P		
WCG000590	REAR ASSY EXHAUST SYSTEM		ENQUIRE
WCG000590P	USE WCG000151P		
WCG000600	REAR ASSY EXHAUST SYSTEM	154.61	181.67
WCG000610	REAR ASSY EXHAUST SYSTEM	152.38	179.05
WCG0003913EVA	METRO 82-84 REAR EXHAUST BOX		ENQUIRE
WCG033166EVA	TAILPIPE EXHAUST SYSTEM	27.71	32.56
WCG033166EVA	EXHAUST REAR ASSY	54.47	64.00
WCG033258EVA	EXHAUST-REAR ASSY		ENQUIRE
WCG033461EVA	EXHAUST-REAR ASSY	27.30	32.08
WCG033504EVA	EXHAUST-REAR ASSY	17.02	20.00
WCG033536EVA	USE WCG033536EVA		
WCG033536EVA	EXHAUST-REAR ASSY	114.32	134.33
WCG033546EVA	EXHAUST-REAR ASSY	68.16	80.09
WCG033546EVA	EXHAUST-REAR ASSY	59.95	70.44
WCG10006EVA	EXHAUST-REAR ASSY	37.34	43.87
WCG10016EVA	EXHAUST-REAR ASSY	81.20	95.41
WCG10059EVA	EXHAUST-REAR ASSY		ENQUIRE
WCG10062EVA	EXHAUST-REAR ASSY	29.15	34.25
WCG10062EVA	REAR EXHAUST ASSY	22.77	26.75
WCG10066EVA	EXHAUST-REAR ASSY		ENQUIRE
WCG10097EVA	EXHAUST-REAR ASSY	21.28	25.00
WCG10108EVA	EXHAUST-REAR ASSY	99.20	116.56
WCG10108EVA	EXHAUST-REAR ASSY	89.95	105.69
WCG10111EVA	EXHAUST-REAR ASSY		ENQUIRE
WCG10114EVA	EXHAUST-REAR ASSY	84.59	99.39
WCG10114EVA	EXHAUST SILENCER	53.62	63.00
WCG10115EVA	EXHAUST-REAR ASSY	93.47	109.83
WCG10115EVA	EXHAUST-REAR ASSY	63.16	74.21
WCG10117EVA	EXHAUST-REAR ASSY	109.67	128.86
WCG10118EVA	EXHAUST-REAR ASSY		ENQUIRE
WCG10120EVA	EXHAUST-REAR ASSY	79.35	93.24
WCG101410EVA	EXHAUST-REAR ASSY	41.79	49.10
WCG101410EVA	USE WCD10061EVA		
WCG101460EVA	USE WCG101460EVA		
WCG101460EVA	EXHAUST-REAR ASSY	36.59	42.99
WCG101480EVA	EXHAUST-REAR ASSY	85.00	99.88
WCG101480EVA	USE WCG10222EVA		
WCG101540EVA	USE GX33565		
WCG101850EVA	EXHAUST-REAR ASSY	109.16	128.26
WCG101890EVA	EXHAUST-REAR ASSY	40.15	47.18
WCG101900EVA	EXHAUST-REAR ASSY		ENQUIRE
WCG101900EVA	EXHAUST-REAR ASSY	36.59	42.99
WCG101910EVA	USE WCG101910SLP		
WCG101910SLP	REAR ASSY EXHAUST SYSTEM	81.09	95.28
WCG101931EVA	EXHAUST-REAR ASSY	56.41	66.28
WCG101931EVA	EXHAUST-REAR ASSY	49.79	58.50
WCG101942EVA	EXHAUST-REAR ASSY	82.52	96.96
WCG101942EVA	EXHAUST SILENCER	74.89	88.00
WCG101971EVA	EXHAUST-REAR ASSY	103.59	121.72
WCG101971SLP	REAR ASSY EXHAUST SYSTEM	114.13	134.10
WCG102061EVA	EXHAUST-REAR ASSY	118.83	139.63
WCG102161EVA	EXHAUST-REAR ASSY	121.02	142.20
WCG102161EVA	EXHAUST-REAR ASSY	101.28	119.00
WCG10222EVA	EXHAUST-REAR ASSY	74.01	86.96
WCG10222EVA	EXHAUST-REAR ASSY	64.68	76.00
WCG102280	REAR ASSY EXHAUST SYSTEM	74.01	86.96
WCG102280P	REAR ASSY EXHAUST SYSTEM	59.56	69.98
WCG102291EVA	EXHAUST-REAR ASSY	89.91	105.64
WCG102291EVA	EXHAUST-REAR ASSY	79.95	93.94
WCG102380EVA	EXHAUST-REAR ASSY	79.30	93.18
WCG102380EVA	USE WCG102610P		
WCG102390EVA	EXHAUST-REAR ASSY	56.65	66.56
WCG102390EVA	EXHAUST-REAR ASSY	45.53	53.50
WCG102410	REAR ASSY EXHAUST SYSTEM	34.04	40.00
WCG102430	REAR ASSY EXHAUST SYSTEM	95.17	111.82
WCG102430P	REAR ASSY EXHAUST SYSTEM	79.95	93.94
WCG102450	USE WCG102450SLP		
WCG102450P	USE WCG108510P		
WCG102450SLP	REAR ASSY EXHAUST SYSTEM	67.97	79.86
WCG102470	REAR ASSY EXHAUST SYSTEM	96.81	113.75
WCG102510EVA	EXHAUST-REAR ASSY	88.01	103.41
WCG102540	REAR ASSY EXHAUST SYSTEM	79.30	93.18
WCG102540P	USE WCG102610P		
WCG102550	REAR ASSY EXHAUST SYSTEM	88.28	103.73
WCG102550P	EXHAUST SILENCER		ENQUIRE
WCG102560	USE WCG102560SLP		
WCG102560SLP	REAR ASSY EXHAUST SYSTEM	84.34	99.10
WCG102610	REAR ASSY EXHAUST SYSTEM	96.75	113.68

Part Number	Description	Price £ Ex VAT	Price £ Inc VAT
WCG102610P	EXHAUST SILENCER	52.77	62.00
WCG102620	REAR ASSY EXHAUST SYSTEM	95.17	111.82
WCG102620P	USE WCG102280P		
WCG102630	REAR ASSY EXHAUST SYSTEM	100.50	118.09
WCG102630P	USE WCG000161P		
WCG102640	REAR ASSY EXHAUST SYSTEM	107.22	125.98
WCG102640P	USE WCG000151P		
WCG102680EVA	EXHAUST-REAR ASSY	27.46	32.27
WCG102690EVA	EXHAUST-REAR ASSY	41.79	49.10
WCG102690EVA	USE WCD10061EVA		
WCG102740	REAR ASSY EXHAUST SYSTEM	102.45	120.38
WCG102831SLP	REAR ASSY EXHAUST SYSTEM	158.66	186.43
WCG102831SLP	EXHAUST ASSY	84.04	98.75
WCG102840SLP	USE WCG102841		
WCG102841P	EXHAUST ASSY	100.42	117.99
WCG102850SLP	REAR ASSY EXHAUST SYSTEM		ENQUIRE
WCG102850SLP	EXHAUST ASSY	86.15	101.23
WCG102980	REAR ASSY EXHAUST SYSTEM	91.05	106.98
WCG103100	USE WCG103100SLP		
WCG103100SLP	OE*REAR EXHAUST ASSY	243.11	285.65
WCG103100SLPP	REAR EXHAUST ASSY - AFTERMARKET	149.95	176.19
WCG103431	USE WCG103431SLP		
WCG103431P	USE WCG103441P		
WCG103431SLP	REAR ASSY EXHAUST SYSTEM	105.78	124.29
WCG103441	REAR ASSY EXHAUST SYSTEM	105.79	124.30
WCG103441P	EXHAUST	89.95	105.69
WCG103451	REAR ASSY EXHAUST SYSTEM	116.33	136.69
WCG103461	REAR ASSY EXHAUST SYSTEM	111.04	130.47
WCG103471	REAR ASSY EXHAUST SYSTEM	87.74	103.09
WCG103471P	EXHAUST SILENCER	79.95	93.94
WCG103481	USE WCG103481SLP		
WCG103481P	USE WCG103471P		
WCG103481SLP	REAR ASSY EXHAUST SYSTEM	94.28	110.78
WCG103490	REAR ASSY EXHAUST SYSTEM	116.33	136.69
WCG103500	REAR ASSY EXHAUST SYSTEM	112.40	132.07
WCG108510	USE WCG108510SLP		
WCG108510P	REAR EXHAUST ASSY	63.62	74.75
WCG108510SLP	REAR ASSY EXHAUST SYSTEM	87.56	102.88
WCG108530	REAR ASSY EXHAUST SYSTEM	111.04	130.47
WCG108540	REAR ASSY EXHAUST SYSTEM	95.17	111.82
WCG108540P	USE WCG108510P		
WCG108550	REAR ASSY EXHAUST SYSTEM	105.75	124.26
WCG108560	REAR ASSY EXHAUST SYSTEM	142.78	167.77
WCGJ000391SLP	CONVERTER ASSY-MANIFOLD EXHAUST	427.04	501.77
WCGJ000391SLPP	CATALYST	230.50	270.84
WCGJ000521SLP	CONVERTER ASSY-MANIFOLD EXHAUST	371.55	436.57
WCGJ000521SLPP	CATALYST	155.73	182.98
WCJ101001	USE WCJ101002		
WCJ101001SLP	USE WCJ101002		
WCJ101001SLPP	USE WCJ101002P		
WCJ101002	CATALYST CONVERTER	411.89	483.97
WCJ101002P	CATALYST	163.40	192.00
WCL000020	CLAMP	32.97	38.74
WCM100090	OE*GASKET MANIFOLD TO D/PIPE 4 STUD	1.51	1.77
WCM100480	OE*EXHAUST GASKET	1.47	1.73
WCO0010600	GASKET D/PIPE TO MANIFOLD - 6 STUD	4.63	5.44
WCO003460EVA	EXHAUST	34.06	40.02
WCS100090	MOUNTING-RUBBER EXHAUST SYSTEM	1.73	2.03
WCU000310	USE WCU000311		
WCU000311	BRACKET ASSY-MOUNTING REAR EXHAUST	16.20	19.04
WCU100760	BRACKET-MOUNTING INTERMEDIATE ASSY	8.47	9.95
WCU100870	BRACKET ASSY-MOUNTING REAR EXHAUST	16.60	19.51
WDB100040	PLATE-MOUNTING BRACKET REAR EXH	11.03	12.96
WDE000177EVA	SILENCER ASSY EXHAUST SYSTEM	38.50	45.24
WDE000177EVA	EXHAUST SYSTEM-TWIN BOX MINI	26.38	31.00
WDE000550	USE WDE000551		
WDE000551	REAR ASSY EXHAUST SYSTEM	168.72	198.25
WDE000551P	REAR ASSY EXHAUST SYSTEM	102.77	120.75
WDE000560	REAR ASSY EXHAUST SYSTEM	142.98	168.00
WDE000591	SILENCER ASSY EXHAUST SYSTEM	385.20	452.61
WDE000601	SILENCER ASSY EXHAUST SYSTEM	331.78	389.84
WDE000611	SILENCER ASSY EXHAUST SYSTEM	312.75	367.48
WDE000621	SILENCER ASSY EXHAUST SYSTEM	312.75	367.48
WDE000690	SILENCER ASSY EXHAUST SYSTEM	300.06	352.57
WDE000700	SILENCER ASSY EXHAUST SYSTEM	300.06	352.57
WDE000710	SILENCER ASSY EXHAUST SYSTEM	288.52	339.01
WDE000720	SILENCER ASSY EXHAUST SYSTEM	288.52	339.01
WDE10002EVA	SILENCER ASSY EXHAUST SYSTEM	101.15	118.85
WDE10002SLP	REAR ASSY EXHAUST SYSTEM	104.20	122.44
WDE100180EVA	EXHAUST-REAR ASSY	84.59	99.39
WDE100180EVA	EXHAUST REAR ASSY	57.87	68.00
WDE100190EVA	EXHAUST-REAR ASSY	93.47	109.83
WDE100190EVA	EXHAUST-REAR ASSY	79.29	93.17
WDE100200EVA	EXHAUST-REAR ASSY	89.67	105.36
WDE100200EVA	EXHAUST SILENCER	74.89	88.00
WDE100330	EXHAUST SYSTEM	79.67	93.61
WDE100520	REAR ASSY EXHAUST SYSTEM	82.52	96.96
WDV100130	FINISHER-TRIM EXHAUST TAILPIPE	74.97	88.09
WEB101150	HEATSHIELD-EXHAUST	43.08	50.62
WFE000081	TANK ASSY-FUEL - LESS PUMP	80.85	95.00
WFE10129	USE WFE10129P		
WFE10129P	TANK ASSY-FUEL	91.90	107.98
WFE10179	TANK ASSY-FUEL		ENQUIRE
WFE10179P	FUEL TANK R200/400 '89-95	109.79	129.00
WFE10211	USE WFE10211P		
WFE10211P	FUEL TANK(PATTERN)R800 '91 ON	144.68	170.00
WFE104760	PETROL TANK ASSY (SINGLE CARB)	42.55	50.00
WFE104890P	FUEL TANK(METRO DIESEL)	90.21	106.00
WFE105180	USE WFE105180P		
WFE105180P	PETROL TANK-ROVER 600(PATTERN)	102.98	121.00

Part Number	Description	Price £ Ex VAT	Price £ Inc VAT
WFE107272	TANK ASSY FUEL DIESEL 3D> R45/MGZ5	59.57	69.99
WFE107371	FUEL TANK ASSY	306.35	359.96
WFG100111	RING-RETAINING-FUEL TANK	1.29	1.52
WFL000090	FILTER ASSY-FUEL	45.06	52.95
WFL100090EVA	USE WFL100090EVA		
WFL100090EVA	PETROL FILTER	17.66	20.75
WFP000120	PIPE ASSY-FILLER-FUEL TANK	63.68	74.82
WFP102140	PIPE-FUEL-UNIT ASSY TANK	81.13	95.33
WFS100201	STRAP ASSY FUEL TANK	5.21	6.12
WFS100211	STRAP ASSY FUEL TANK		ENQUIRE
WFX000350	PUMP-FUEL TANK	367.42	431.72
WFX10022	PUMP-FUEL TANK	213.69	251.09
WFX10025	PUMP-FUEL TANK	233.19	274.00
WFX10027	PUMP-FUEL TANK	380.61	447.22
WFX10033	FUEL PUMP 2L TURBO PETROL	63.83	75.00
WFX10038	PUMP-FUEL TANK	20.89	24.55
WFX10045	FUEL PUMP	239.52	281.44
WFX10045P	FUEL PUMP	146.34	171.95
WFX100580	PUMP-FUEL TANK	25.74	30.24
WFX100590	PUMP-FUEL TANK	326.74	383.92
WFX100631	PUMP-FUEL-UNIT ASSY FUEL TANK	217.70	255.80
WFX100631P	FUEL PUMP		ENQUIRE
WFX100670	PUMP-FUEL TANK	277.49	326.05
WFX100670P	FUEL PUMP AND TANK UNIT COMPLETE	100.00	117.50
WFX100691	PUMP-FUEL TANK	46.81	55.00
WFX100691	PUMP-FUEL TANK	167.79	197.15
WFX100760	PUMP-FUEL TANK	294.94	346.55
WFX100780	PUMP-FUEL TANK	271.25	318.72
WFX100780P	FUEL PUMP	162.30	190.70
WFX100790	PUMP-FUEL TANK		ENQUIRE
WFX100800	PUMP-FUEL TANK	138.32	162.53
WFX100810	PUMP-FUEL TANK	239.52	281.44
WFX100860	PUMP-FUEL TANK	239.03	280.86
WFX100910	PUMP-FUEL TANK	263.84	310.01
WFX100933	PUMP-FUEL TANK	264.91	311.27
WFX100961	PUMP-FUEL TANK	123.63	145.27
WFX101010	PUMP-FUEL TANK	168.37	197.83
WFX101160	PUMP-FUEL TANK	229.41	269.56

WYE100350-XFB101040

WEB ORDER - YOU SHOP - WE DELIVER. www.rimmerbros.co.uk

Part Number	Description	Price £ Ex VAT	Price £ Inc VAT
WYE100350	CLAMP	32.70	38.42
WYE100360	CLAMP	32.70	38.42
XAP109	LIGHT UNIT	45.55	53.52
XAP109P	HEADLAMP UNIT RHD H4 HAL.MGB	28.51	33.50
XAP131	UNIT-LIGHT,		ENQUIRE
XAP39A	PAINT-AEROSOL SPRAY	10.20	11.99
XAP39C	PAINT PENCIL	5.49	6.45
XBC000520	HEADLAMP ASSY-FRONT RH	167.82	197.19
XBC000530	HEADLAMP ASSY-FRONT LH	167.82	197.19
XBC000540	HEADLAMP ASSY-FRONT RH	167.82	197.19
XBC000550	HEADLAMP ASSY-FRONT LH	167.82	197.19
XBC000560	HEADLAMP ASSY-FRONT LIGHTING	140.30	164.85
XBC000561	HEADLAMP ASSY	123.70	145.35
XBC000570	HEADLAMP ASSY-FRONT LIGHTING	140.30	164.85
XBC000571	HEADLAMP ASSY	123.70	145.35
XBC000580	USE XBC000581		
XBC000581	HEADLAMP ASSY-FRONT LIGHTING	123.70	145.35
XBC000590	USE XBC000591		
XBC000591	HEADLAMP ASSY-FRONT LIGHTING	123.70	145.35
XBC000640	HEADLAMP/PILOT/INDICATOR ASSY	157.56	185.13
XBC000650	HEADLAMP/PILOT/INDICATOR ASSY	166.23	195.32
XBC000660	HEADLAMP/PILOT/INDICATOR ASSY	166.23	195.32
XBC000670	HEADLAMP/PILOT/INDICATOR ASSY	166.23	195.32
XBC0002160	HEADLAMP ASSY	226.29	265.89
XBC0002170	HEADLAMP ASSY	226.29	265.89
XBC0002180	HEADLAMP ASSY	226.29	265.89
XBC0002190	HEADLAMP ASSY	218.79	257.08
XBC0002500	HEADLAMP/PILOT/INDICATOR ASSY	317.20	372.71
XBC0002510	HEADLAMP/PILOT/INDICATOR ASSY	317.20	372.71
XBC0002520	HEADLAMP/PILOT/INDICATOR ASSY	317.20	372.71
XBC0002530	HEADLAMP/PILOT/INDICATOR ASSY	317.20	372.71
XBC0002540	HEADLAMP ASSY-FRONT LIGHTING	192.54	226.23
XBC0002550	HEADLAMP ASSY-FRONT LIGHTING	199.14	233.99
XBC0002560	HEADLAMP ASSY-FRONT LIGHTING	199.14	233.99
XBC0002570	HEADLAMP ASSY-FRONT LIGHTING	199.14	233.99
XBC0002630	HEADLAMP ASSY-FRONT LIGHTING	199.14	233.99
XBC0002640	HEADLAMP ASSY-FRONT LIGHTING	192.54	226.23
XBC0002650	HEADLAMP ASSY-FRONT LIGHTING	199.14	233.99
XBC0002660	HEADLAMP ASSY-FRONT LIGHTING	188.75	221.78
XBC0002680	HEADLAMP/PILOT/INDICATOR ASSY	218.79	257.08
XBC0002690	HEADLAMP/PILOT/INDICATOR ASSY	218.79	257.08
XBC0002700	HEADLAMP/PILOT/INDICATOR ASSY	225.34	264.77
XBC0002710	HEADLAMP/PILOT/INDICATOR ASSY	225.34	264.77
XBC0002720	HEADLAMP/PILOT/INDICATOR ASSY	220.93	259.59
XBC0002730	HEADLAMP/PILOT/INDICATOR ASSY	225.34	264.77
XBC0002740	HEADLAMP/PILOT/INDICATOR ASSY	218.79	257.08
XBC0002750	HEADLAMP/PILOT/INDICATOR ASSY	218.79	257.08
XBC0002760	HEADLAMP ASSY-FRONT LIGHTING	226.29	265.89
XBC0002770	HEADLAMP ASSY	226.29	265.89
XBC0002780	LAMP-SIDE & FLASHER-LH(WHITE LENS)	226.29	265.89
XBC0002790	HEADLAMP ASSY	226.29	265.89
XBC0002800	HEADLAMP ASSY-FRONT LIGHTING	433.03	508.81
XBC0002810	HEADLAMP ASSY-FRONT LIGHTING	447.89	526.27
XBC0002820	HEADLAMP ASSY	226.29	265.89
XBC0002830	HEADLAMP ASSY	226.29	265.89
XBC0002840	HEADLAMP ASSY	179.60	211.03
XBC0002850	HEADLAMP ASSY		ENQUIRE
XBC0002860	HEADLAMP ASSY-FRONT LIGHTING	433.03	508.81
XBC0002870	HEADLAMP ASSY-FRONT LIGHTING	416.37	489.23
XBC0002880	HEADLAMP ASSY-FRONT LIGHTING	127.88	150.26
XBC0002890	HEADLAMP ASSY-FRONT LIGHTING	130.99	153.91
XBC0002910	HEADLAMP ASSY-FRONT LIGHTING	124.16	145.89
XBC0002970	HEADLAMP ASSY-FRONT LIGHTING	135.65	159.39
XBC0002980	HEADLAMP ASSY-FRONT LIGHTING	135.65	159.39
XBC0002990	HEADLAMP ASSY-FRONT LIGHTING-RH	135.65	159.39
XBC003000	HEADLAMP ASSY-FRONT LIGHTING	140.30	164.85
XBC003010	HEADLAMP ASSY-FRONT LIGHTING	135.65	159.39
XBC003020	HEADLAMP ASSY-FRONT LIGHTING	140.30	164.85
XBC003030	HEADLAMP ASSY-FRONT LIGHTING	140.30	164.85
XBC003040	HEADLAMP ASSY-FRONT LIGHTING	140.30	164.85
XBC10030	HEADLAMP ASSY-RH	82.72	97.20
XBC10030P	HEADLAMP ASSY-RH	67.23	79.00
XBC10031	USE XBC10031P		
XBC10031P	HEADLAMP ASSY-LH	44.25	51.99
XBC10032	HEADLAMP ASSY		ENQUIRE
XBC10033	HEADLAMP ASSY	161.23	189.45
XBC10103	USE GLU132		
XBC10170	HEADLAMP ASSY		ENQUIRE
XBC10170P	HEADLAMP RH	40.85	48.00
XBC10171	HEADLAMP ASSY. LH RHD.	21.27	24.99
XBC10172	HEADLAMP ASSY	93.38	109.72
XBC10173	HEADLAMP ASSY		ENQUIRE
XBC10197	HEADLAMP MTG ASSY		ENQUIRE
XBC10278	HEADLAMP ASSY	89.24	104.86
XBC10278P	HEADLAMP RH	58.72	69.00
XBC10279	HEADLAMP ASSY	89.24	104.86
XBC10279P	HEADLAMP LH	57.62	67.70
XBC10280	HEADLAMP ASSY	99.53	116.95
XBC10281	HEADLAMP ASSY	99.53	116.95
XBC10284	HEADLAMP ASSY	126.23	148.32
XBC10285	HEADLAMP ASSY		ENQUIRE
XBC10286	HEADLAMP ASSY	102.96	120.98
XBC10286P	HEADLAMP RH	63.17	74.22
XBC10287	HEADLAMP ASSY-FRONT LIGHTING	102.96	120.98
XBC10287P	HEADLAMP LH	63.17	74.22
XBC10288	HEADLAMP ASSY-FRONT LIGHTING	102.96	120.98
XBC10289	HEADLAMP ASSY-FRONT LIGHTING	102.96	120.98

Part Number	Description	Price £ Ex VAT	Price £ Inc VAT
XBC10290	HEADLAMP ASSY-FRONT LIGHTING	102.96	120.98
XBC10291	HEADLAMP ASSY-FRONT LIGHTING	102.96	120.98
XBC103020	HEADLAMP ASSY	130.53	153.37
XBC103020P	HEADLAMP RH	49.87	58.60
XBC103030	USE XBC103030P		
XBC103030P	HEADLAMP LH	49.87	58.60
XBC103040	HEADLAMP ASSY	130.53	153.37
XBC103050	HEADLAMP ASSY	130.53	153.37
XBC103070	USE XBC103050		
XBC103080	HEADLAMP ASSY	122.52	143.96
XBC103090	HEADLAMP ASSY	122.52	143.96
XBC103140	HEADLAMP ASSY	24.50	28.79
XBC103150	HEADLAMP ASSY	24.50	28.79
XBC103160	HEADLAMP/PILOT LAMP	166.72	195.90
XBC103170	HEADLAMP/PILOT LAMP	16.50	19.39
XBC103190	HEADLAMP/PILOT LAMP	166.72	195.90
XBC103200	HEADLAMP/PILOT LAMP	85.79	100.80
XBC103200P	HEADLAMP LH	62.06	72.92
XBC103220	HEADLAMP ASSY	139.78	164.24
XBC103360	H/LIGHT UNIT-RHD 75/50W	8.30	9.75
XBC103410	UNIT-LIGHT	43.76	51.42
XBC103410P	USE R87409		
XBC103420	HEADLAMP ASSY	114.98	135.10
XBC103430	HEADLAMP ASSY	140.64	165.25
XBC103440	HEADLAMP ASSY	114.98	135.10
XBC103440P	HEADLAMP RH	66.49	78.13
XBC103450	HEADLAMP ASSY	114.98	135.10
XBC103450P	HEADLAMP LH	66.49	78.13
XBC103460	HEADLAMP ASSY	109.20	128.31
XBC103460P	HEADLAMP RH	59.56	69.98
XBC103470	HEADLAMP ASSY	109.20	128.31
XBC103470P	HEADLAMP LH	59.56	69.98
XBC103480	HEADLAMP ASSY	109.20	128.31
XBC103490	HEADLAMP ASSY	105.00	123.38
XBC103520	HEADLAMP/PILOT LAMP	131.27	154.24
XBC103530	HEADLAMP/PILOT LAMP	131.27	154.24
XBC103540	HEADLAMP ASSY	114.98	135.10
XBC103540P	HEADLAMP RH	73.14	85.94
XBC103550	HEADLAMP ASSY	114.98	135.10
XBC103550P	HEADLAMP LH	73.14	85.94
XBC103560	HEADLAMP ASSY	169.23	198.85
XBC103570	HEADLAMP ASSY	169.23	198.85
XBC103640	HEADLAMP/PILOT LAMP		ENQUIRE
XBC103650	HEADLAMP/PILOT LAMP	85.79	100.80
XBC103670	HEADLAMP/PILOT LAMP	143.97	169.16
XBC103780	HEADLAMP ASSY	143.97	169.16
XBC103980	HEADLAMP ASSY-FRONT LIGHTING	447.89	526.27
XBC103990	HEADLAMP ASSY-FRONT LIGHTING	447.89	526.27
XBC104000	HEADLAMP ASSY-FRONT LIGHTING	433.03	508.81
XBC104010	HEADLAMP ASSY-FRONT LIGHTING	447.89	526.27
XBC104020	HEADLAMP ASSY-FRONT RH	145.00	170.38
XBC104020P	HEADLAMP ASSY-FRONT-RH	114.85	134.95
XBC104030	HEADLAMP ASSY-FRONT LH	145.00	170.38
XBC104030P	HEADLAMP ASSY-FRONT-LH	114.85	134.95
XBC104040	HEADLAMP ASSY-FRONT RH	149.95	176.19
XBC104050	HEADLAMP ASSY-FRONT LH	149.95	176.19
XBC104060	HEADLAMP ASSY	143.97	169.16
XBC104140	HEADLAMP ASSY-FRONT LIGHTING	112.28	131.93
XBC104140P	HEADLAMP RH	63.83	75.00
XBC104150	HEADLAMP ASSY-FRONT LIGHTING	112.28	131.93
XBC104150P	HEADLAMP LH	63.83	75.00
XBC104380	HEADLAMP ASSY	132.90	156.16
XBC104380P	HEADLAMP RH	108.08	126.99
XBC104390	HEADLAMP ASSY	132.90	156.16
XBC104390P	HEADLAMP LH	108.08	126.99
XBC104430	HEADLAMP ASSY	55.94	65.73
XBC104500	HEADLAMP/PILOT/INDICATOR ASSEM	187.98	220.88
XBC104510	HEADLAMP/PILOT/INDICATOR ASSEM	187.98	220.88
XBC104520	HEADLAMP/PILOT/INDICATOR ASSEM	166.52	195.66
XBC104530	HEADLAMP/PILOT/INDICATOR ASSEM	187.98	220.88
XBC104540	HEADLAMP/PILOT/INDICATOR ASSEM		ENQUIRE
XBC104550	HEADLAMP/PILOT/INDICATOR ASSEM	134.85	158.45
XBC104640	HEADLAMP ASSY	126.20	148.29
XBC104650	HEADLAMP ASSY		ENQUIRE
XBC104660	HEADLAMP ASSY	121.34	142.57
XBC104670	HEADLAMP ASSY	117.81	138.43
XBC104680	HEADLAMP ASSY	105.52	123.99
XBC104690	HEADLAMP ASSY	105.52	123.99
XBC104700	HEADLAMP ASSY	99.06	116.40
XBC104710	HEADLAMP ASSY	99.06	116.40
XBC104720	HEADLAMP ASSY	132.56	155.76
XBC104730	HEADLAMP ASSY	8.03	9.44
XBC104740	HEADLAMP ASSY	11.81	13.88
XBC104750	HEADLAMP ASSY	126.23	148.32
XBC104960	HEADLAMP ASSY-FRONT LIGHTING	140.30	164.85
XBC104961	HEADLAMP ASSY-FRONT LIGHTING	123.70	145.35
XBC104970	USE XBC104971		
XBC104971	HEADLAMP ASSY-FRONT LIGHTING	123.70	145.35
XBC104980	HEADLAMP ASSY-FRONT LIGHTING	131.71	154.76
XBC104981	HEADLAMP ASSY-FRONT LIGHTING	123.70	145.35
XBC104990	HEADLAMP ASSY-FRONT LIGHTING	131.71	154.76
XBC105210	HEADLAMP ASSY		ENQUIRE
XBC105220	HEADLAMP ASSY	143.97	169.16
XBC105230	HEADLAMP ASSY	143.97	169.16
XBC105420	HEADLAMP ASSY	96.70	113.62
XBC105430	HEADLAMP ASSY		ENQUIRE
XBD000010	LAMP-DIRECTION IND	45.86	53.89
XBD000060	USE XBD000121		
XBD000070	USE XBD000131		
XBD000090	LAMP ASSY-DIRECTION INDICATOR	40.49	47.58

Part Number	Description	Price £ Ex VAT	Price £ Inc VAT
XBD000100	LAMP-FRONT BUMPER DIRECT INDICATOR	47.73	56.08
XBD000110	LAMP-FRONT BUMPER DIRECT INDICATOR	47.73	56.08
XBD000120	LAMP ASSY-DIRECTION INDICATOR	31.26	36.73
XBD000121	LAMP ASSY-DIRECTION INDICATOR	31.26	36.73
XBD000130	USE XBD000131		
XBD000131	LAMP ASSY-DIRECTION INDICATOR	31.26	36.73
XBD000140	LAMP-FRONT BUMPER INDICATOR	28.98	34.05
XBD000150	LAMP-FRONT BUMPER INDICATOR	28.98	34.05
XBD000160	LAMP ASSY-DIRECTION INDICATOR	27.79	32.65
XBD000170	LAMP ASSY-DIRECTION INDICATOR	30.04	35.30
XBD000180	LAMP-FRONT BUMPER INDICATOR	29.91	35.14
XBD10040	LAMP-DIRECTION IND	22.33	26.24
XBD10041	USE ZUA000390		
XBD10056	LAMP ASSY-DIRECTION INDICATOR	33.62	39.50
XBD10056P	LAMP ASSY-DIRECTION INDICATOR	18.30	21.50
XBD10057	LAMP ASSY-DIRECTION INDICATOR	33.62	39.50
XBD10057P	LAMP ASSY-DIRECTION INDICATOR	18.30	21.50
XBD10060	LAMP ASSY-DIRECTION INDICATOR	33.17	38.97
XBD10061	LAMP ASSY-DIRECTION INDICATOR	33.17	38.97
XBD100640	LAMP-FRONT DIRECTION INDICATOR	37.57	44.14
XBD100650	LAMP-FRONT DIRECTION INDICATOR	37.57	44.14
XBD100670	LAMP-INDICATOR	19.45	22.85
XBD100670P	CLEAR INDICATOR	8.30	9.75
XBD100670SLP	LAMP-FRONT DIRECTION INDICATOR	15.70	18.45
XBD101020	LAMP-FRONT DIRECTION INDICATOR	37.57	44.14
XBD101030	LAMP-DIRECTION IND	37.57	44.14
XBD500010	OE*LAMP ASSY	30.17	35.45
XBI000040	BURNER-HEADLAMP XEON	104.33	122.59
XBJ000010	LAMP ASSY-FRONT LIGHTING FOG	45.42	53.37
XBJ100260	LAMP ASSY-FRONT LIGHTING FOG	45.41	53.36
XBJ100270	LAMP ASSY-FRONT LIGHTING FOG	45.41	53.36
XBJ100500	LAMP ASSY-FRONT LIGHTING FOG	42.32	49.73
XBJ100510	LAMP ASSY-FRONT LIGHTING FOG	35.00	41.13
XBQ000120	HOLDER-BULB-LIGHTING	5.70	6.70
XBQ000130	KIT-FRONT LIGHTING FOG LAMP		ENQUIRE
XBQ000130	KIT-FRONT LIGHTING FOG LAMP	20.46	24.04
XBQ000140	KIT-FRONT LIGHTING FOG LAMP		ENQUIRE
XBQ10047	KIT-PARTS-HEADLAMP	8.51	10.00
XBQ100620	FRONT FOG LAMP KIT 1991->		ENQUIRE
XBQ100700	KIT-PARTS-HEADLAMP	70.19	82.47
XBQ100710	KIT-PARTS-HEADLAMP	70.19	82.47
XBQ100730	KIT-FRONT LIGHTING FOG LAMP		ENQUIRE
XBQ100790	FRONT FOG LAMP KIT 1989 - 1996	12.98	15.25

Part Number	Description	Price £ Ex VAT	Price £ Inc VAT
XFB101050	LAMP ASSY-REAR	104.09	122.31
XFB101060	LAMP ASSY-REAR	55.94	65.73
XFB101070	LAMP ASSY-REAR	55.94	65.73
XFB101200	USE XFB101900		
XFB101210	USE XFB101910		
XFB101300	LAMP ASSY-REAR	144.14	169.36
XFB101300P	LAMP ASSY-REAR RH	124.25	145.99
XFB101310	LAMP ASSY-REAR	144.14	169.36
XFB101310P	LAMP ASSY-REAR LH	124.25	145.99
XFB101420	LAMP ASSY-REAR	105.60	124.08
XFB101420P	LAMP ASSY-REAR-RH	97.87	115.00
XFB101430	LAMP ASSY-REAR	105.60	124.08
XFB101600	LAMP ASSY-REAR RH	144.14	169.36
XFB101610	LAMP ASSY-REAR LH	144.14	169.36
XFB101660	LAMP ASSY-REAR	117.67	138.26
XFB101670	LAMP ASSY-REAR	117.67	138.26
XFB101900	LAMP ASSY-REAR	98.68	115.95
XFB101900P	RH REAR LAMP WITH REVERSE LIGHT MINI	51.90	60.98
XFB101910	LAMP ASSY-REAR	98.68	115.95
XFB101910P	LH REAR LAMP WITH REVERSE LIGHT MINI	51.90	60.98
XFB500248	USE XFB000248		
XFB500258	USE XFB000258		
XFC000200	LAMP-REAR LICENCE PLATE	27.31	32.09
XFC100290PMT	USE XFC000200		
XFE10006	LAMP-FOG-REAR	43.38	50.97
XFE10007	LAMP-FOG-REAR	43.27	50.84
XFG000050	LAMP ASSY-REAR HIGH MOUNTED STOP	73.28	86.10
XFG100230	LAMP-REAR HIGH MOUNTED STOP	70.70	83.07
XFH100440	GASKET-LAMP ASSY-RR	14.63	17.19
XFJ10002	LENS AND HOUSING ASSY-REAR LAMP-RH	74.52	87.56
XFJ10003	LENS AND HOUSING ASSY-REAR LAMP-LH	ENQUIRE	
XFJ10018	LENS-REAR LAMP	78.96	92.78
XFJ10019	LENS-REAR LAMP	78.96	92.78
XFJ10022	LENS-FOG/RVS LAMP	ENQUIRE	
XFJ10023	LENS-FOG/RVS LAMP	ENQUIRE	
XFJ100380	LENS/HOUSING ASSY-RR	47.75	56.11
XFJ100390	LENS/HOUSING ASSY-RR	47.75	56.11
XFM100180	HOLDER-BULB-LAMP RR RH	17.20	20.21
XFM100190	HOLDER-BULB-LAMP RR LH	17.20	20.21
XFN100160	KIT-HMSL REAR	ENQUIRE	
XFN100180	KIT-HMSL REAR	68.12	80.04
XFT100020	USE GLB382		
XFT100030	BULB	0.59	0.69
XG00040	SPARK PLUG LEAD EACH	5.11	6.00
XG00060	SPARK PLUG LEAD EACH	5.11	6.00
XGB000020	OE*LAMP-SIDE REPEATER 2000 MY >	17.24	20.26
XGB000020P	LAMP-SIDE REPEATER 2000 MY >	2.53	2.97
XGB000060A	LAMP-SIDE REPEATER	11.47	13.48
XGB000060AP	USE XGB000020P		
XGB100310	LAMP ASSY-AUXILI	12.79	15.03
XH00040	IGN.COIL LEAD EACH	5.11	6.00
XHM436EVAP	GASKET	5.32	6.25
XHM5384EVA	ELEMENT AIR CLEANER	34.37	40.38
XHM5384EVA	AIR FILTER	28.94	34.00
XKB10003	SWITCH STOP LAMP	17.99	21.14
XKB100080	SWITCH-STOP LAMP	12.95	15.22
XKB100090	USE C16062A		
XKC2528	INERTIA SEAT BELT KIT EACH.15CM.STALK	37.03	43.51
XKC2528SA	INERTIA SEAT BELT KIT EACH.30CM.STALK	37.03	43.51
XKD10004	USE XKD10004SLP		
XKD10004SLP	SWITCH STOP LAMP	20.67	24.29
XL0000110	BULB	24.43	28.71
XNB000030	SENSOR UNIT FUEL TANK	79.77	93.73
XNB10007	SENSOR UNIT-FUEL TNK	51.98	61.08
XNB10007P	SENSOR UNIT-FUEL TNK	15.96	18.75
XNB10008	SENSOR UNIT-FUEL TNK	56.17	66.00
XNB10008P	SENSOR UNIT-FUEL TNK	26.81	31.50
XP1040PS1	XPOWER 10W 40 PART SYNTHETIC OIL	3.94	4.63
XP1040PSS	XPOWER 10W 40 PART SYNTHETIC OIL	19.78	23.24
XP1540D1	XPOWER 15W 40 MINERAL OIL DIESEL (1L)	4.35	5.11
XP1540D5	XPOWER 15W 40 MINERAL OIL DIESEL (5L)	19.68	23.12
XP1540P1	XPOWER 15W 40 MINERAL OIL PETROL (1L)	4.35	5.11
XP1540P5	XPOWER 15W 40 MINERAL OIL PETROL (5L)	19.68	23.12
XP1ATFG	USE GGL505		
XP1LL	ANT 5 COOLANT 1 LTR 5 YEAR LIFE ORANGE	3.97	4.66
XP20AF	ANTI FREEZE 20L LONG LIFE YELLOW	59.38	69.77
XP30PS1	XPOWER 5W 30 PART SYNTHETIC OIL (1L)	4.66	5.48
XP30PSS	XPOWER 5W 30 PART SYNTHETIC OIL (5L)	22.75	26.73
XP540FS1	XPOWER 5W 40 FULLY SYNTHETIC OIL (1L)	5.92	6.96
XP540FS5	XPOWER 5W 40 FULLY SYNTHETIC OIL (5L)	26.98	31.70
XP5AF	USE GAC2019		
XP5LL	ANTI-FREEZE 5 LTR.	18.95	22.27
XPB000300PMP	SWITCH-MASTER LIGHTING /INDI/HEAD	137.82	161.94
XPB10006	SWITCH ASSY-STRG COL	34.00	39.95
XPC100050	SWITCH-INDICATOR	11.52	13.54
XPC100142PUPY	SWITCH-INDICATOR (LUCAS)	ENQUIRE	
XPC100151PUPY1	SWITCH-INDICATOR (LUCAS)	55.28	64.95
XPC100200PMP	SWITCH-INDICATOR	126.20	148.29
XPCHF11S	FLUID-HYDRAULIC	12.55	14.75
XPE000050PMP	SWITCH-WASH/WIPE WINDSCREEN	130.93	153.84
XPE10012P1	SWITCH ASSY-WASH/WIPE FRONT & REAR	13.40	15.75
XPE10014P1	SWITCH-WASH/WIPE (LUCAS)	13.40	15.75
XPE100321PUPY1	SWITCH-WASH/WIPE (LUCAS)	31.06	36.50
XPE100420PMP	SWITCH-WASH/WIPE WINDSCREEN	59.37	69.76
XPE100430P1	SWITCH-WASH/WIPE WINDSCREEN(LUCAS)	13.40	15.75
XPH100100	HOUSING-COLUMN SWI	ENQUIRE	
XPSY21L	SYNER-Z 5W30	10.76	12.64
XPSY25L	SYNER-Z 5W30	52.34	61.50
XPT000004ACA	USE RX1399		
XPT00005ACA	STEBEL AIR HORN RED	19.83	23.30

Part Number	Description	Price £ Ex VAT	Price £ Inc VAT
XPT000006ACA	TYRE PRESSURE GAUGE	7.16	8.41
XPT000010ACA	SILENCER REAR	ENQUIRE	
XPT000010ACB	EXHAUST THROUGHFLOW X POWER	168.74	198.27
XPT000012ACA	HARD WIRED PHONE CONTROLLER	ENQUIRE	
XPT000019ACA	PHONE MOUNTING (MECHANICAL)	1.00	1.18
XPT000019ACB	TELEPHONE MOUNTING (MAGNETIC)	3.09	3.63
XPT000029ACA	EXHAUST	146.78	172.47
XPT000029ACB	EXHAUST THROUGHFLOW X POWER	225.43	264.88
XPT000030ACA	EXHAUST X POWER	250.65	294.51
XPT000030ACB	EXHAUST X POWER	167.38	196.67
XPT000035ACA	M3 MIRRORS	ENQUIRE	
XPT000035ACB	M3 STYLE MIRRORS	29.39	34.53
XPT000036ACA	M3 MIRROR CHEATERS	4.25	4.99
XPT000038ACA	FRONT RUBBER MATS-LHD GREY	4.26	5.01
XPT000039ACA	EXHAUST ELBOW KIT - MGF TO 522573	50.21	59.00
XPT000039ACB	USE XPT000039ACBP		
XPT000039ACBP	S/STEEL REAR SPORTS EXHAUST-REAR MUDFLAP KIT (CITY ROVER)	245.00	287.88
XPT000065ACA	REAR MUDFLAP KIT (CITY ROVER)	8.51	10.00
XPT000068ACB	OVERMAT SET LHD-GRAPHITE CITY ROVER	8.51	10.00
XPT000075ACA	MUDFLAPS-FRONT	8.51	10.00
XPT000083ACA	BLUETOOTH PHONE KIT	ENQUIRE	
XPT000086PMA	USE XPT000086PMAP		
XPT000086PMP	MGF/HOOD (TO 98) BLACK	374.47	440.00
XPT000087CVG	MGF/TF HOOD (98 ON) BURGUNDY	353.19	415.00
XPT000087HZP	MGF/TF HOOD (98 ON) GREEN	353.19	415.00
XPT000087JZP	MGF/TF HOOD (98 ON) DARK BLUE	353.19	415.00
XPT000087LFM	MGF/TF HOOD (98 ON) DARK GREY	353.19	415.00
XPT000087LZD	MGF/TF HOOD (98 ON) GREY	353.19	415.00
XPT000087PMA	MGF/TF HOOD (98 ON) BLACK	353.19	415.00
XPT000087PMA	NW MGF/TF HOOD **NO WINDOW**	319.15	375.00
XPT000087RIO	MGF/TF HOOD (98 ON) BEIGE	314.85	369.95
XPT000091CCV	BACKLIGHT ASSY.PLASTIC (BUR)	279.36	328.25
XPT000091CCVP	BACKLIGHT ASSY.PLASTIC (BURG) OEM	148.94	175.00
XPT000091CVG	B/LIGHT ASSY.PLASTIC 75TH ANIV.(BUR)	208.50	244.99
XPT000091CVGP1	B/LIGHT ASSY.PLAS 75TH ANIV.(BUR) OEM148.94	175.00	
XPT000091HZZP	USE XPT000091HZZP1		
XPT000091HZZP1	BACKLIGHT ASSY.PLASTIC (GREEN) OEM	148.94	175.00
XPT000091JZP	USE XPT000091JZP1		
XPT000091JZP1	BACKLIGHT ASSY.PLASTIC (BLUE) OEM	148.94	175.00
XPT000091LFM	BACKLIGHT ASSY.PLASTIC (CHARCOAL)	211.15	248.10
XPT000091LFMP1	BACKLIGHT ASSY.PLAS (CHARCOAL) OEM148.94	175.00	
XPT000091LZD	USE XPT000091LZD1		
XPT000091LZD1	BACKLIGHT ASSY.PLASTIC (GREY) OEM	148.94	175.00
XPT000091PMA	BACKLIGHT ASSY.PLASTIC (BLACK)	215.56	253.28
XPT000091PMP1	BACKLIGHT ASSY.PLASTIC (BLACK) OEM	148.94	175.00
XPT000091RIO	BACKLIGHT ASSY.PLASTIC (BEIGE)	188.18	221.11
XPT000091RIO1	BACKLIGHT ASSY.PLASTIC (BEIGE) OEM	148.94	175.00
XPT000091SBT	BACKLIGHT ASSY.PLASTIC (DRIFTWOOD)	279.36	328.25
XPT000094ACA	USE OTHER XPT000094ACA VARIANTS		
XPT000094ACAPBLACK	USE OTHER XPT000094ACA VARIANTS		
XPT000094ACAPCHROME	USE OTHER XPT000094ACA VARIANTS		
XPT000094ACAPTECHGRM	TECHNO CHROME (PR)	139.56	163.98
XPT000094ACAPTECHBLK	TECHNO BLACK (PR)	139.56	163.98
XPT000094ACAPTECHNO	USE OTHER XPT000094ACA VARIANTS		
XPT000096ACA	CARRIER CYCLE	31.25	36.72
XPT000097ACA	EXHAUST THROUGHFLOW X POWER	170.72	200.60
XPT000097ACB	EXHAUST THROUGHFLOW X POWER	ENQUIRE	
XPT000097ACC	EXHAUST THROUGHFLOW X POWER	ENQUIRE	
XPT000097ACD	EXHAUST THROUGHFLOW X POWER	ENQUIRE	
XPT000102ACA	USE XPT000102ACA		
XPT000107CVG	USE XPT000107CVGP		
XPT000107CVGP	SPORTSTER HOOD BURGUNDY	553.19	650.00
XPT000107CXP	USE XPT000107CXP		
XPT000107CXPP	SPORTSTER HOOD RED	553.19	650.00
XPT000107CYP	SPORTSTER HOOD PURPLE MGT	297.87	350.00
XPT000107FXP	SPORTSTER HOOD YELLOW MGT	297.87	350.00
XPT000107HZP	USE XPT000107HZPP		
XPT000107HZPP	SPORTSTER HOOD GREEN	553.19	650.00
XPT000107JXP	USE XPT000107JXPP		
XPT000107JXPP	SPORTSTER HOOD BRIGHT BLUE	553.19	650.00
XPT000107JZP	USE XPT000107JZPP		
XPT000107JZPP	SPORTSTER HOOD DARK BLUE	553.19	650.00
XPT000107LFM	USE XPT000107LFMP		
XPT000107LFMP	SPORTSTER HOOD DARK GREY	553.19	650.00
XPT000107LZD	USE XPT000107LZDP		
XPT000107LZDP	SPORTSTER HOOD GREY	553.19	650.00
XPT000107PMA	USE XPT000107PMAP		
XPT000107PMP	SPORTSTER HOOD BLACK	553.19	650.00
XPT000107RIO	USE XPT000107RIO1		
XPT000107RIO1	SPORTSTER HOOD BEIGE	553.19	650.00
XPT000107SBT	USE XPT000107SBTP		
XPT000107SBTP	SPORTSTER HOOD DRIFTWOOD FLECK	553.19	650.00
XPT000108MML	SAFETY ROLL HOOP *CHROME*	225.00	264.38
XPT000108MWK	SAFETY ROLL HOOP *WHITE SILVER*	235.00	276.13
XPT000110ACA	MUDGUARD	8.51	10.00
XPT000110ACB	MUDGUARD	7.25	8.52
XPT000111ACA	MUDGUARD	ENQUIRE	
XPT000113ACA	HEADLAMP BEAM	8.51	10.00
XPT000113ACB	HEADLAMP BEAM CONVERSION STICKERS	6.24	7.33
XPT000116ACA	BULB KIT	4.41	5.18
XPT000117ACA	TOW BAR DETACHABLE	175.40	206.10
XPT000117ACC	TOW BAR DETACHABLE	131.88	154.96
XPT000122ACA	SPORTSTER HOOD PROTECTOR	26.88	31.58
XPT000123CXF	SPORTSTER HOOD STOWAGE COVER	97.78	114.89
XPT000123FXP	SPORTSTER HOOD STOWAGE COVER	97.78	114.89
XPT000123JXP	SPORTSTER HOOD STOWAGE COVER	86.25	101.34
XPT000123PMA	SPORTSTER HOOD STOWAGE COVER	137.87	162.00
XPT000125ACA	SLIMLINE SUBWOOFER	127.84	150.21
XPT000128ACA	XPOWER THRUFLOW EXHAUST	188.37	221.33
XPT000128ACB	XPOWER THRUFLOW EXHAUST	ENQUIRE	

Part Number	Description	Price £ Ex VAT	Price £ Inc VAT
XPT000130ACA	CAR MAT SET	36.57	42.97
XPT000130ACB	FABRIC CAR MAT SET *LHD*	8.51	10.00
XPT000132ACA	R 25 / ZR REAR LAMP	95.18	111.84
XPT000135ACA	WINDSTOP	ENQUIRE	
XPT000136ACA	ROLL HOOP TRIM KIT	62.33	73.24
XPT000138ACA	XTRA KIT - ESSENTIALS	12.72	14.95
XPT000139ACA	XTRA KIT - INTERIOR CARE	12.72	14.95
XPT000141ACA	XTRA KIT - TOURING	18.51	21.75
XPT000142ACA	XTRA KIT - SAFETY	ENQUIRE	
XPT000152ACA	CHROME SPORTS TAIL LIGHTS	ENQUIRE	
XPT000152ACB	USE XPT000152ACBP		
XPT000152ACBP	PRODESIGN BLACK REAR LAMP PAIR	85.11	100.00
XPT000173CVG-E	HOOD GLASS BACKLIGHT - EXCHANGE SURCHARGE	914.37	1074.38
XPT000173JZP-E	HOOD GLASS BACKLIGHT - EXCHANGE SURCHARGE	864.65	1015.96
XPT000173LZD-E	HOOD GLASS BACKLIGHT - EXCHANGE SURCHARGE	864.65	1015.96
XPT000173PMA-E	HOOD GLASS BACKLIGHT - EXCHANGE SURCHARGE	960.08	1128.09
XPT000173RIO-E	HOOD GLASS BACKLIGHT - EXCHANGE SURCHARGE	864.65	1015.96
XPT000174CVG-E	HOOD GLASS BACKLIGHT - EXCHAN SURCHARGE	704.76	828.09
XPT000174HZP-E	HOOD GLASS BACKLIGHT - EXCHAN SURCHARGE	704.76	828.09
XPT000174JZP-E	HOOD GLASS BACKLIGHT - EXCHAN SURCHARGE	725.90	852.93
XPT000174LZD-E	HOOD GLASS BACKLIGHT - EXCHAN SURCHARGE	704.76	828.09
XPT000174PMA-E	HOOD GLASS BACKLIGHT - EXCHAN SURCHARGE	740.00	869.50
XPT000174RIO-E	HOOD GLASS BACKLIGHT - EXCHAN SURCHARGE	704.76	828.09
XPT000175ACC	MGTF LOCKING WHEEL NUT KIT	18.31	21.51
XPT000177PXI	INDUCTION KIT S.O.O.	ENQUIRE	
XPT000178PXI	INDUCTION KIT S.O.O.	71.35	83.84
XPT000179PXI	INDUCTION KIT S.O.O.	63.34	74.42
XPT000180PXI	INDUCTION KIT S.O.O.	68.10	80.02
XPT000181PXV	VIPER KIT S.O.O.	ENQUIRE	
XPT000182PXV	VIPER KIT S.O.O.	191.18	224.64
XPT000183PXV	VIPER KIT S.O.O.	190.81	224.20
XPT000184PXV	REPLACEMENT PANEL FILTER S.O.O	29.32	34.45
XPT000185PXV	REPLACEMENT PANEL S.O.O.	31.86	37.44
XPT000186PXV	REPLACEMENT FILTER S.O.O.	35.00	41.13
XPT001000OF	CVT FLUID	175.52	206.24
XPT001001OF	USE XPT001002OF		
XPT001002OF	CVT FLUID - 1 LITRE	8.62	10.13
XPT002100AC	STEBEL AIR HORN, BLACK	20.25	23.79
XPT00600			

YAC004790PMP-ZUA000610

Part Number	Description	Price £ Ex VAT	Price £ Inc VAT
YAC004790PMP	INSTRUMENT PACK	34.04	40.00
YAC004850PMP	INSTRUMENT PACK		ENQUIRE
YAC004860PMP	INSTRUMENT PACK	34.04	40.00
YAC004910PMP	INSTRUMENT PACK	34.04	40.00
YAC004930PMP	INSTRUMENT PACK	326.52	383.66
YAC004940PMP	INSTRUMENT PACK		ENQUIRE
YAC004950PMP	INSTRUMENT PACK	152.40	179.07
YAC004960PMP	INSTRUMENT PACK-1.8 AUTO K.P.H.		ENQUIRE
YAC004970PMP	INSTRUMENT PACK	383.93	451.12
YAC004980PMP	INSTRUMENT PACK-1.8VVC K.P.H.		ENQUIRE
YAC112381N	INSTRUMENT PACK		ENQUIRE
YAD000060	GAUGE-OIL TEMPERATURE		ENQUIRE
YAD000090	GAUGE-FUEL	19.90	23.38
YAD000100	GAUGE-TEMPERATURE	96.27	113.12
YAD100480	GAUGE-OIL TEMP	61.12	71.82
YAD100500	GAUGE-FUEL	102.68	120.65
YAD100510	GAUGE-TEMPERATURE	98.86	116.16
YAD100760	GAUGE-OIL TEMP	79.69	93.64
YAD100890	GAUGE-OIL TEMP	72.51	85.20
YAD100970	GAUGE-FUEL		ENQUIRE
YAD100980	GAUGE-TEMPERATURE	94.44	110.97
YAD101020	GAUGE-OIL TEMP	19.90	23.38
YAE000010PMA	SPEEDOMETER	139.08	163.42
YAE000020PMA	SPEEDOMETER	29.85	35.07
YAE000030PMA	SPEEDOMETER	102.03	119.89
YAE100470	TACHOMETER	92.95	109.22
YAE100480	TACHOMETER		ENQUIRE
YAE100840	TACHOMETER	98.41	115.63
YAE100850	TACHOMETER	93.13	109.43
YAE100860	TACHOMETER	89.55	105.22
YAH100410	PCB-INSTRUMENT PACK	5.48	6.44
YAH100790	PCB-INSTRUMENT PACK	24.13	28.35
YAJ100230	HOLDER ASSY & BULBS	3.07	3.61
YAJ100250	HOLDER ASSY & BULBS		ENQUIRE
YAJ100260	HOLDER ASSY & BULBS		ENQUIRE
YAQ100360PMP	COWL ASSY-INSTRUMENT PACK		ENQUIRE
YAQ100370PMP	COWL ASSY-INSTRUMENT PACK		ENQUIRE
YAQ100590PMP	COWL ASSY-INSTRUMENT PACK	34.55	40.60
YBC101120	SPEEDOMETER ASSY	29.85	35.07
YBC101130	SPEEDOMETER ASSY		ENQUIRE
YBC101610	SPEEDOMETER ASSY	279.55	328.47
YBC101611	SPEEDOMETER ASSY	214.47	252.00
YBC101612	SPEEDOMETER ASSY	137.51	161.57
YBC101613	SPEEDOMETER ASSY	137.51	161.57
YBC101614	SPEEDOMETER ASSY	264.55	310.85
YBC101615	SPEEDOMETER ASSY	145.29	170.72
YBC101616	SPEEDOMETER ASSY	129.72	152.42
YBC101620	SPEEDOMETER ASSY	254.39	298.91
YBC101630	SPEEDOMETER ASSY	279.55	328.47
YBC101640	SPEEDOMETER ASSY	264.55	310.85
YBC101650	SPEEDOMETER ASSY		ENQUIRE
YBC101660	SPEEDOMETER ASSY	29.85	35.07
YBD000010EVA	CABLE-SPEEDOMETER	14.35	16.86
YBD000010EVAP	USE GSD152P		
YBD000031SEVAP	CABLE-SPEEDOMETER MGB'76>0D	7.02	8.25
YBD000041SEVA	CABLE-SPEEDOMETER	29.77	34.98
YBD000041SEVAP	SPEDO CABLE MINI	8.94	10.50
YBD0000417EVA	CABLE-SPEEDOMETER	24.05	28.26
YBD0000418EVA	CABLE-SPEEDOMETER	15.37	18.06
YBD10075EVA	CABLE-SPEEDOMETER	26.40	31.02
YBD10101EVA	CABLE-SPEEDOMETER	22.25	26.14
YBD10101EVAP	SPEDO CABLE MINI	10.21	12.00
YBD101250	CABLE SPEEDOMETER	44.61	52.42
YBD101580	CABLE SPEEDOMETER	29.74	34.94
YBD101590	CABLE SPEEDOMETER	21.08	24.77
YBD101640	CABLE SPEEDOMETER	42.17	49.55
YBD101660	CABLE SPEEDOMETER	55.93	65.72
YBE100520	TRANSDUCER-SPEED	45.20	53.11
YCB000010EVA	TRANSMITTER-TEMPERATURE	5.46	6.42
YCB000010EVAP	TEMP. TRANSMITTER	4.17	4.90
YCB10014EVAP	TRANSMITTER-WATER TEMPERATURE	7.23	8.50

ACKNOWLEDGEMENT

Certain images courtesy of magiccarpics.co.uk

"Errors & Omissions Excepted. All parts offered subject to availability. Correct at August 2010. We reserve the right to alter prices without notice. Replaces all previous price guides. All part numbers, illustrations and photographs used in our catalogues are intended for reference /identification purposes only, and are not necessarily an exact representation of the goods supplied. Whilst we make every effort to ensure the accuracy of product descriptions in our catalogues, they are based upon information supplied by the manufacturer/ distributor at the time of publication. There may be occasions - due to circumstances beyond our control - when specifications are changed, or when goods become temporarily unavailable." Certain part numbers have been superseded to an alternative number when a later version or updated specification is offered.

© Copyright Rimmer Bros Limited. All rights reserved. No part of this publication may be copied, reproduced, stored in any retrieval system, communicated or transmitted in any form or by any means, including Photocopying, Electronic, Mechanical or otherwise, without prior permission from Rimmer Bros Limited.

WEB ORDER - YOU SHOP - WE DELIVER. www.rimmerbros.co.uk

Part Number	Description	Price £ Ex VAT	Price £ Inc VAT	Part Number	Description	Price £ Ex VAT	Price £ Inc VAT
YCB100270	TRANSDUCER-OIL TEMP		ENQUIRE	YUG101470PMA	SWITCH-FOG-FRONT	7.72	9.07
YCB100290	TRANSDUCER-OIL TEMP	28.26	33.21	YUG101480PMA	SWITCH-HRW	9.71	11.41
YCB100350	USE YCB100350P			YUG101490PMA	SWITCH-AIR CON		ENQUIRE
YCB100350P	TRANSDUCER-OIL TEMPERATURE		ENQUIRE	YUG101680PMP	SWITCH-FOG-FRONT	10.37	12.18
YCB100420	TRANSDUCER COOLANT TEMPERATURE	12.75	14.98	YUG101720	SWITCH-AIR CON	7.72	9.07
YEB100770	HORN HIGH NOTE	30.83	36.23	YUG101830PMA	SWITCH-FOG-REAR	7.71	9.06
YEB100780	HORN LOW NOTE	29.98	35.23	YUG101900PMP	SWITCH-HAZARD	15.16	17.81
YFB000240	CLOCK ANALOGUE	87.30	102.58	YUG102570PMP	SWITCH-PUSH PUSH HEATED R/WINDOW	16.40	19.27
YFB100240	CLOCK-ANALOGUE	113.20	133.01	YUG102580PMP	SWITCH-AIR CON	15.61	18.34
YFB100450	CLOCK-ANALOGUE	104.07	122.28	YUG102590PMP	SWITCH-FOG-FRONT	15.61	18.34
YGD000120	USE ZUA000096E			YUG102600PMP	SWITCH-AIR CON	7.52	8.84
YGD000140	BATTERY	59.35	69.74	YUG102740PMP	SWITCH-FOG-REAR	11.34	13.32
YGD000290	USE ZUA000027E			YUG103220WDH	SWITCH PACK	9.93	11.67
YGD000380	USE ZUA000077E			YUG103230WDH	SWITCH PACK	9.93	11.67
YGD10012	USE ZUA000027E			YUJ10024	CIGAR LIGHTER ASSY	20.33	23.89
YGD100231B	USE ZUA000063SP			YUJ10031	POP OUT-CIGAR LIGHTER	18.56	21.81
YGD100241B	BATTERY	60.65	71.26	YUJ100770MMM	CIGAR LIGHTER ASSY		ENQUIRE
YGD100360	USE ZUA000063E			YUR10007	SWITCH-THUMBWHEEL ILLUMIN CONTROL		ENQUIRE
YGD100500	BATTERY		ENQUIRE	YWB000410	USE YWB10012L		
YGD100510	USE ZUA000054E			YWB000440	RELAY CHANGEOVER	16.06	18.87
YGD100520	USE GBA3015			YWB10012L	OE-RELAY	5.55	6.52
YGD100790	USE ZUA000027E			YWB100800	USE YWB100801		
YGD100800	USE ZUA000096E			YWB100801	RELAY	60.23	70.77
YGD100810	BATTERY	38.60	45.36	YWB100970	RELAY ASSY-ENG MANAG	41.78	49.09
YGD100950	USE ZUA000027E			YWC000720	CONTROL UNIT POWER ASS/STEERING	391.97	460.56
YGD101030	BATTERY	34.89	41.00	YWC000980	CONTROL UNIT BURGLAR ALARM	188.59	221.59
YJF10003	CLAMP-FIXING BATTERY	3.87	4.55	YWC001541	CONTROL UNIT BURGLAR ALARM	301.05	353.73
YLE101530	USE YLE101530P OR YLE101530E			YWC001551	CONTROL UNIT BURGLAR ALARM	271.97	319.56
YLE101530E	ALTERNATOR - EXCHANGE SURCHARGE	135.64	159.38	YWC10050P	CONTROL UNIT DIM DIP	12.75	14.98
YLE101530P	ALTERNATOR	100.00	117.50	YWC103773	CONTROL UNIT-PAS	401.78	472.09
YLE101790E	ALTERNATOR	84.25	98.99	YWC104500	CONTROL UNIT MULTI FUNCTION	57.89	68.02
YLE101790EP	ALTERNATOR MINI MPI SURCHARGE	132.77	156.00	YWC105340	CONTROL UNIT BURGLAR ALARM	193.55	227.42
YLE102370E	ALTERNATOR - EXCHANGE SURCHARGE	222.71	261.68	YWC106170	CONTROL UNIT ELEC WINDOW LIFT	127.07	149.31
YLE102430	USE YLE102430E			YWC106740	CONTROL UNIT POWER ASS/STEERING	391.32	459.80
YLE102430E	ALTERNATOR - EXCHANGE SURCHARGE	149.76	175.97	YWD100082	MODULE-KEY TRANSPONDER ANTENNA	12.77	15.00
YLE102430EP	ALTERNATOR SURCHARGE	121.28	142.50	YWK10003	BATTERY-B/ALARM	3.12	3.67
YMQ003000	HARNES-LINK		ENQUIRE	YWK10003P PAIR	PAIR CR2032 BATTERIES	2.71	3.18
YPC116330	CONNECTOR ASSY HARNES	2.95	3.47	YWK10004	BATTERY-B/ALARM INC 2 BATS	3.95	4.64
YPC116330L	OE*CONNECTOR	2.93	3.44	YWT10003	FLASHER UNIT (NO TOWING SOCKET)	27.85	32.72
YPP100290	BASE-FUSEBOX	113.61	133.49	YWT10003P	FLASHER UNIT (NO TOWING SOCKET)	8.30	9.75
YPP100310	BASE-FUSEBOX	52.45	61.63	YWX000290	TRANSMITTER RADIO REMOTE (MG)	74.07	87.03
YQE000400	FUSEBOX ASSY ENGINE COMPARTMENT		ENQUIRE	YWX000310	TRANSMITTER RADIO REMOTE	48.43	56.91
YQE000510	FUSE BOX		ENQUIRE	YWX000320	TRANSMITTER RADIO REMOTE	52.94	62.20
YQE101740	USE YPP100310			YWX101010	TRANSMITTER-B/ALARM	3.40	4.00
YQE103670	FUSEBOX ASSY-ENGINE		ENQUIRE	YWX101220A	TRANSMITTER-RADIO	61.25	71.97
YQF10001	FUSEBLOCK	4.85	5.70	YWX101220AP	TRANSMITTER-RADIO	47.23	55.50
YQG10009	FUSE	8.78	10.32	YXJ100130PMA	BLANK-SWITCH	1.73	2.03
YQG10013	OE*FUSE	1.29	1.52	YXW000130PMA	SOCKET-ACCESSORY POWER	8.84	10.39
YQH000210	COVER FUSEBOX		ENQUIRE	YXX4633PMA	FASTENER-DRIVE	1.24	1.46
YQH100440	COVER-FUSEBOX	12.03	14.14	YYG10005A	BOLT	0.94	1.10
YQH101090	COVER FUSEBOX	10.94	12.85	ZKC5121	HEATER CONTROL MECHANISM	30.64	36.00
YQR100750	CLIP.	0.84	0.99	ZLA000001AF	USE XP1LL		
YRC100300	COUPLER-ROTARY-STRG	114.61	134.67	ZLA000005	USE XP5LL		
YSB002390	LINK LEAD	6.64	7.80	ZLA000020	ANTIFREEZE 20 LTR LONG LIFE	65.53	77.00
YTA000330	CABLE-BATTERY POSITIVE	23.39	27.48	ZUA000015E	USE GBA3015		
YTA000440	CABLE-BATTERY POSITI	11.42	13.42	ZUA000025	SERVICE KIT - R25 & MGZR	35.00	41.13
YTA000450	CABLE-BATTERY POSITI		ENQUIRE	ZUA000027E	BATTERY	64.99	76.36
YTA100700	CABLE-BATTERY-POS	27.19	31.95	ZUA000038E	USE GBA3015		
YTA107080	CABLE-BATTERY-POS		ENQUIRE	ZUA000054E	BATTERY	38.60	45.36
YTB000310	CABLE-BATTERY NEGATIVE		ENQUIRE	ZUA000063E	BATTERY	47.50	55.81
YUE10005	USE YUE10005L			ZUA000063SP	BATTERY	53.09	62.38
YUE10005L	OE*SWITCH-GLOVEBOX	6.31	7.41	ZUA000070	FAN-COOLING	118.60	139.36
YUE10005LP	SWITCH-GLOVEBOX	4.08	4.79	ZUA000077E	BATTERY	60.87	71.52
YUE10011	SWITCH-BONNET-ALARM	6.28	7.38	ZUA000080	MLS GASKET SET WITH OIL RAIL	148.45	174.43
YUF10028	SWITCH-ROCKER	36.56	42.96	ZUA000096E	BATTERY	64.99	76.36
YUF101030P	SWITCH-LIGHTS-MINI	9.15	10.75	ZUA000170	CAMSHAFT COVER GASKET	10.78	12.67
YUF101060PMA	SWITCH-ROCKER	11.73	13.78	ZUA000200	COLUMN ASSY STEERING SYSTEM	160.09	188.11
YUF101880PMP	SWITCH-ROCKER	17.05	20.03	ZUA000380	LAMP-FRONT DIRECTION INDICATOR	23.40	27.50
YUF101890PMP	SWITCH-ROCKER	74.79	87.88	ZUA000390	LAMP-FRT.DIRECTION INDICATOR	24.69	29.01
YUG001060PMP	SWITCH-FOG LAMPS		ENQUIRE	ZUA000510LML	SPOILER ASSY-TAILGATE	311.91	366.49

UPDATE COUPON

CHANGE OF CUSTOMER DETAILS

Please use this coupon to inform us if you have moved, changed phone number, vehicle type or you have sold your vehicle.

NAME _____

CUSTOMER No. _____ E-MAIL ADDRESS _____

ADDRESS _____

POST CODE _____

TEL No. _____

OLD ADDRESS (if different) _____

POST CODE _____

OLD TEL No. (if different) _____

VEHICLE(S) OWNED _____

I HAVE SOLD MY VEHICLE. I HAVE CHANGED MY VEHICLE. I ALSO NOW HAVE A _____

Please cut out and post, fax or inform us next time you call.

PHOTOCOPIES ACCEPTED

ORDER FORM

PLEASE SEE OTHER SIDE

PLEASE COMPLETE BOTH PARTS OF THIS FORM AND EITHER FAX OR POST TO US

PART ONE

CUSTOMER DETAILS

NAME: _____ CUSTOMER NUMBER: _____

HOME ADDRESS: _____

_____ POSTCODE/ZIP: _____

DAY TIME TEL NO: _____ MOBILE NO: _____ FAX NO: _____

E-MAIL: _____

DELIVERY ADDRESS (IF DIFFERENT)

NAME: _____

DELIVERY ADDRESS: _____

_____ POSTCODE/ZIP: _____

CAR DETAILS

TICK APPROPRIATE BOX

MAKE: _____ MODEL: _____ YEAR: _____

CHASSIS NUMBER: _____ ENGINE NUMBER: _____

PAYMENT DETAILS

TICK APPROPRIATE BOX

- CREDIT CARD VISA/MASTERCARD
- DEBIT CARD DELTA/MAESTRO/OPTIMA
- CHARGE CARD AMEX/DINERS

- BANK CHEQUE ££s Sterling
- BANK TRANSFER (see below)

NAME ON CARD _____

CARD NO. _____

SECURITY CODE _____ (LAST 3 NUMBERS ON SIGNATURE STRIP) (AMEX - 4 NUMBERS ON FACE OF CARD)

EXPIRY DATE _____ / _____

ISSUE NO. _____ (MAESTRO ONLY)

START DATE _____ (MAESTRO ONLY)

CARDHOLDER SIGNATURE _____

NOTE: ALL TRANSACTIONS MUST BE MADE IN ££s STERLING, AND BANK CHEQUES MUST BE DRAWN ON A LONDON BANK.

If paying by bank transfer, please add £7.00 to cover bank charges.
NAT WEST Bank, Account No. 05839874, Sort Code 54-10-23.

££ sterling IBAN No. GB74NWBK54102305839874.
Euro IBAN No. GB25NWBK60720906848516.
IBAN BIC CODE NWBKGB2L.



RIMMER BROS, TRIUMPH HOUSE, SLEAFORD ROAD, BRACEBRIDGE HEATH, LINCOLN LN4 2NA, ENGLAND.
 TELEPHONE: 01522 563344. FAX: 01522 567600. E MAIL: mgrover@rimmerbros.co.uk www.rimmerbros.co.uk



288 PAGES

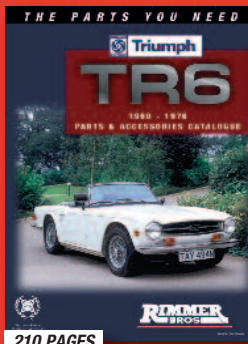

210 PAGES

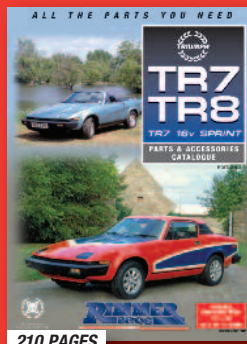

210 PAGES



170 PAGES

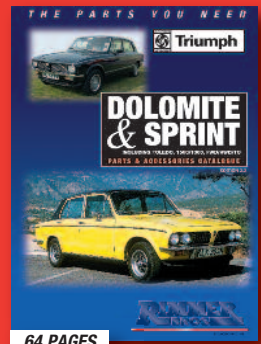

64 PAGES



194 PAGES

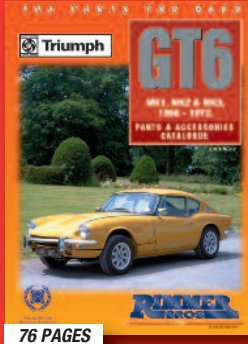

76 PAGES

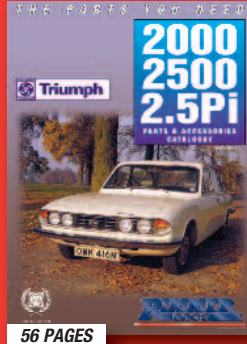

56 PAGES



82 PAGES

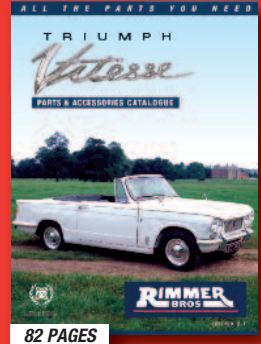

82 PAGES

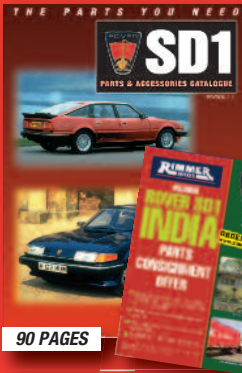

90 PAGES



106 PAGES

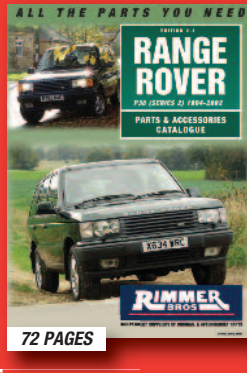

72 PAGES

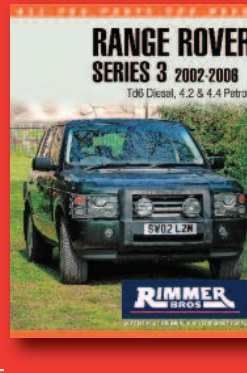

108 PAGES

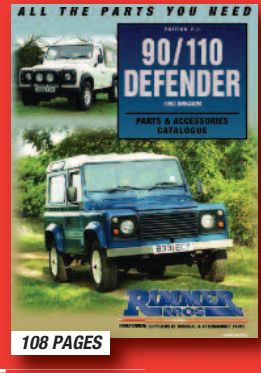

108 PAGES

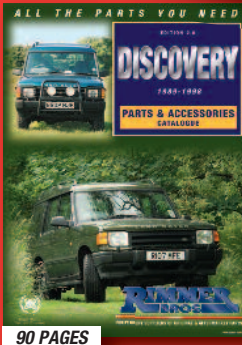

90 PAGES

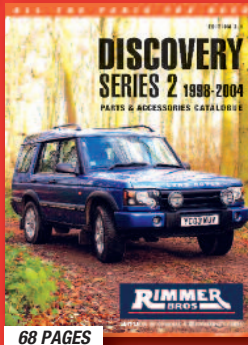

68 PAGES

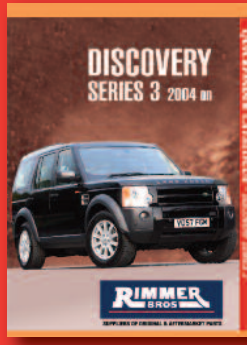

32 PAGES

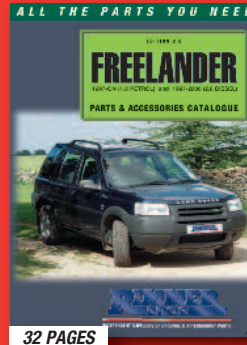

32 PAGES



32 PAGES

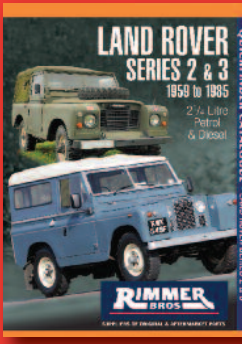

44 PAGES



152 PAGES



152 PAGES



152 PAGES



152 PAGES

RIMMER BROS CATALOGUES

If you are a Triumph, SD1, MG Rover, New MINI, Range Rover, Freelander, Defender or Discovery owner - a catalogue will be despatched **FREE** including post & packing.

Small postage charge made for additional catalogues. **FOR YOUR COPY, PHONE, FAX, WRITE OR E-MAIL.**

FULL SET OF CATALOGUES (POSTAGE CHARGES)
£10 (UK) £15 (Europe) £35 (Rest of World)

Once registered as a customer for a specific vehicle you will be automatically updated (free of charge) with any new catalogue or price guides as they are published.

OUR CATALOGUES ARE YOUR PASSPORT TO THE FINEST MAIL-ORDER PARTS SERVICE



BROWSE OUR CATALOGUES ON YOUR PC!
COVERS LAND ROVER, TRIUMPH AND MG ROVER.

ALL THE PARTS YOU NEED



NOW STOCKING NEW MINI (BMW), MGB & MG MIDGET PARTS TOO!

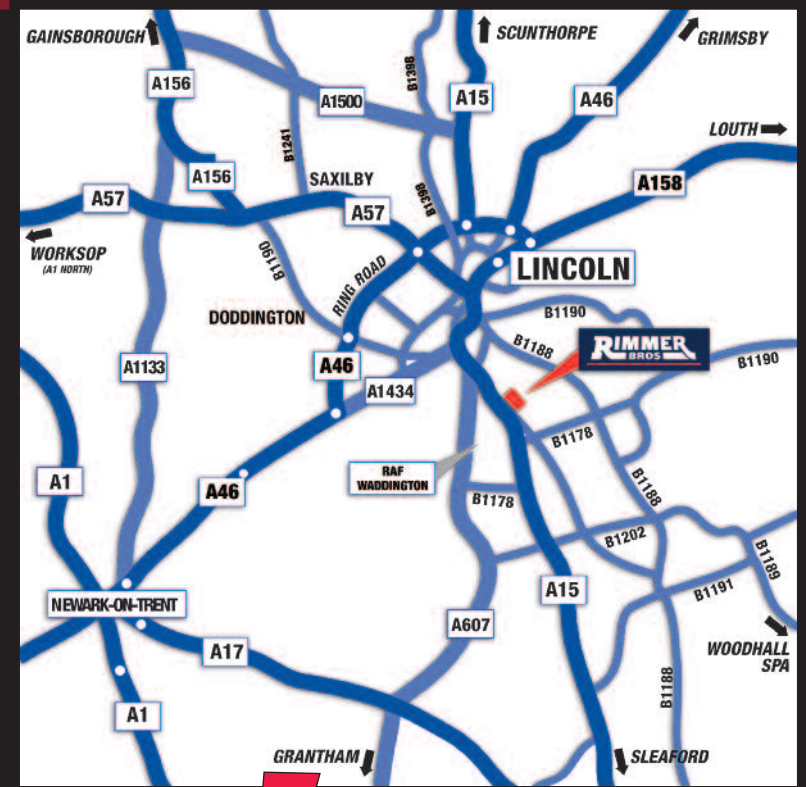

HOW TO FIND US

We are 2 miles south of Lincoln on the A15 Lincoln to Sleaford road.
When approaching Lincoln from the A1/A46, follow the A1434 signposted to city centre, through North Hykeham, then pick up signs for the A15 to Sleaford. Set your Sat Nav LN4 2NA.

BUSINESS HOURS

8.30am - 5.30pm Monday to Friday and 8.30am - 1pm on Saturday. We are closed Sunday and on all Bank Holidays except Good Friday.



Rimmer Bros. Triumph House, Sleaford Road, Bracebridge Heath, Lincoln LN4 2NA England.

Sales: 01522 568000. (OUTSIDE UK +44 1522 568000).

Fax: 01522 567600. (OUTSIDE UK +44 1522 567600). E-MAIL: mgrover@rimmerbros.co.uk

www.rimmerbros.co.uk Visit our Interactive Website

TRADE ENQUIRIES WELCOME: 01522 567111. E-mail: trade@rimmerbros.co.uk

THE CLASSIC PARTS SERVICE